



苏州固得电子股份有限公司
SUZHOU GOODARK ELECTRONICS CO., LTD

Version #	91002	Issue date:	Jan.1,1991
Revision#	91002A	Issue Date:	Mar.15,2012
Revision#	91002B	Issue Date	Mar. 20,2012
Revision#	91002C	Issue Date	Mar. 29, 2012

Customer's product name	Goodark's product name
	GD LL4148-TR (RoHS Compliant)

CONTENTS

1. CASE DIMENSION
2. MARKING
3. TAPING SPECIFICATION & PACKAGING
4. MAXIMUM RATINGS
5. ELECTRICAL CHARACTERISTICS
6. LABEL SPEC
7. PACKING SPEC
8. THE RECOMMENDATION FOR REFLOW SOLDERING CONDITION
9. DATABOOK REFERENCE
10. SVHC COMPLIANT

Customer Acknowledgement

Manufacturer
Suzhou Goodark Electronics
Co., Ltd.



苏州固得电子股份有限公司
SUZHOU GOODARK ELECTRONICS CO., LTD

CHANGE RECORD						
NO.	ITEM	Before Change	After Change	The reson of Change	Confirmed by	Date
1.	Add plating material(finish)	Non	Plating thickness: 4um to 12um Plating material: Pure tin (99.99%)	Complete spec	C.X.Zhen	Mar. 15, 2012
2.	Add time at peak temperature	Non	260±5°C max.5sec	Complete spec	Jack. Li	Mar. 15, 2012
3.	Add SVHC compliant	Non	Added	Complete spec	C.X.Zhen	Mar. 15, 2012
4.	Revise SVHC compliant			Complete spec	C.X.Zhen	Mar. 20, 2012
5.	Revise SVHC complaint			Complete spec	C.X.Zhen	Mar. 29, 2012



1. CASE DIMENSION (MINI-MELF/SOD80)

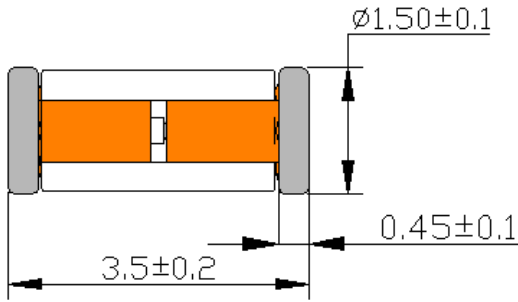

Plating thickness: 4um to 12um
Plating material: Pure tin(99.99%)

2. MARKING

There's no difference on the parts.

Part No.s are marked on the reel labels, inner box labels and cartons.

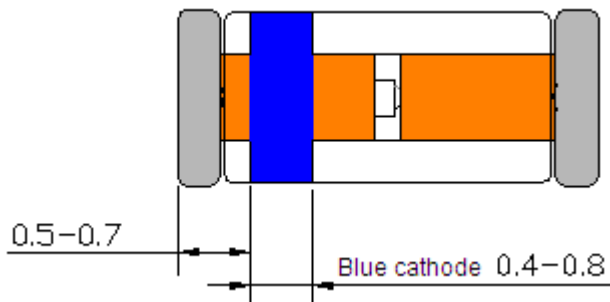

3. TAPING SPECIFICATION & PACKAGING

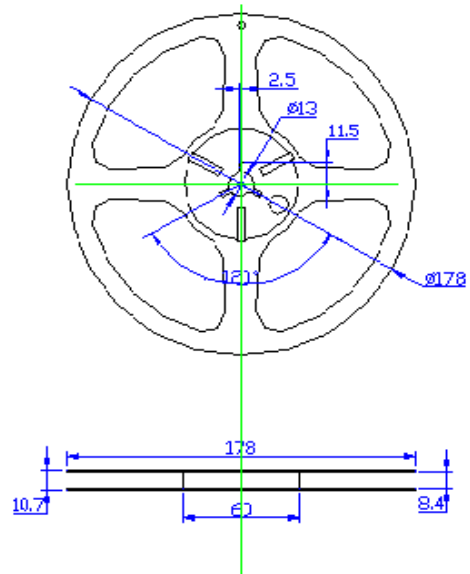
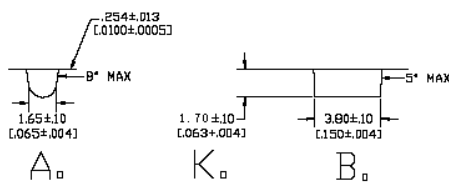
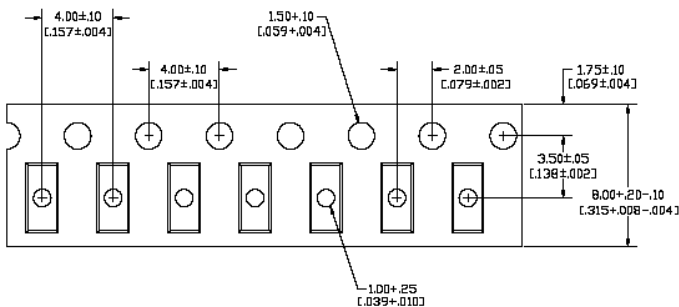

TEL: 0086-512-8618 8888
Fax: 0086-512-6818 1222

nan Rd.,
China.



4. MAXIMUM RATINGS ($T_A=25^{\circ}\text{C}$)

Parameter	Symbol	Limit	Unit
Reverse voltage	V_R	75	Volts
Peak reverse voltage	V_{RM}	100	Volts
Forward DC current at $T_{amb}=25^{\circ}\text{C}$ ⁽¹⁾	I_F	200	mA
Average rectified current half wave rectification with resistive load at $T_{amb}=25^{\circ}\text{C}$ $f \geq 50$ Hz ⁽¹⁾	$I_{F(AV)}$	150	mA
Surge forward current at $t < 1\text{s}$ and $T_j=25^{\circ}\text{C}$	I_{FSM}	500	mA
Power dissipation at $T_{amb}=25^{\circ}\text{C}$ ⁽¹⁾	P_{tot}	500	mW
Thermal resistance junction to ambient air ⁽²⁾	$R_{\theta JA}$	350	$^{\circ}\text{C/W}$
Thermal resistance junction to tie-point	$R_{\theta Jtp}$	300	$^{\circ}\text{C/W}$
Operation Junction temperature	T_{opr}	175	$^{\circ}\text{C}$
Storage temperature range	T_S	-65 to +175	$^{\circ}\text{C}$

Note: 1.Valid provided that electrodes are kept at ambient temperature

2.Device mounted on FR4 printed-circuit board

5. ELECTRICAL CHARACTERISTICS ($T_a=25^{\circ}\text{C}$)

Parameter	Symbol	Test Condition	Min.	Typ.	Max.	Unit
Forward voltage	V_F	$I_F=10\text{mA}$	-	-	1.0	Volt
Leakage current	I_R	$V_R=20\text{V}$	-	-	25	nA
		$V_R=75\text{V}$	-	-	5.0	μA
		$V_R=20\text{V}, T_j=150^{\circ}\text{C}$	-	-	50	μA
Capacitance	C_{tot}	$V_F=V_R=0\text{V}, f=1\text{MHz}$	-	-	4.0	pF
Voltage rise when switching ON (tested with 50mA forward pulses)	V_{fr}	$t_p=0.1\mu\text{s}$, Rise time < 30ns $f_p=5$ to 100kHz	-	-	2.5	Volts
Reverse recovery time	t_{rr}	$I_F=10\text{mA}, I_R=1\text{mA}$ $V_R=6\text{V}, R_L=100\Omega$	-	-	4.0	ns
Rectification efficiency	η_V	$f=100\text{MHz}, V_{RF}=2\text{V}$	0.45	-	-	-



Forward characteristics

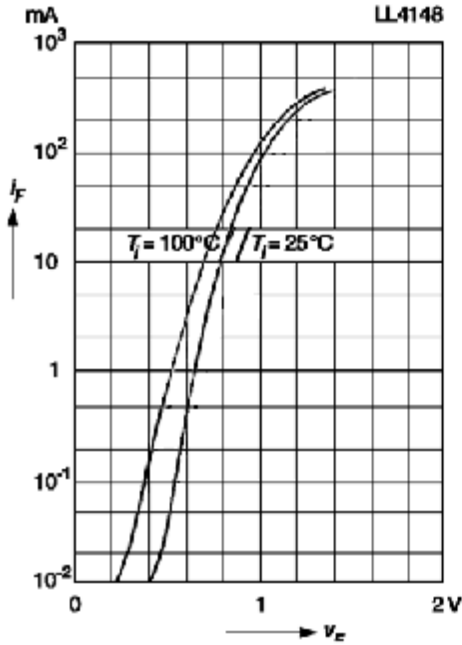

Dynamic forward resistance versus forward current

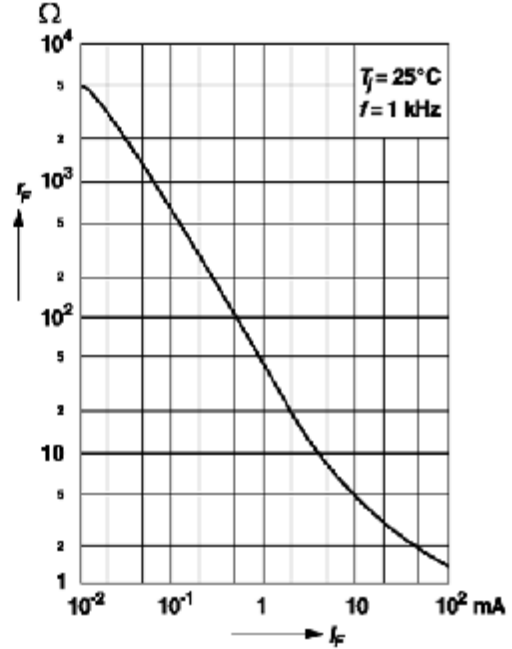

Admissible power dissipation versus ambient temperature

Valid provided that electrodes are kept at ambient temperature

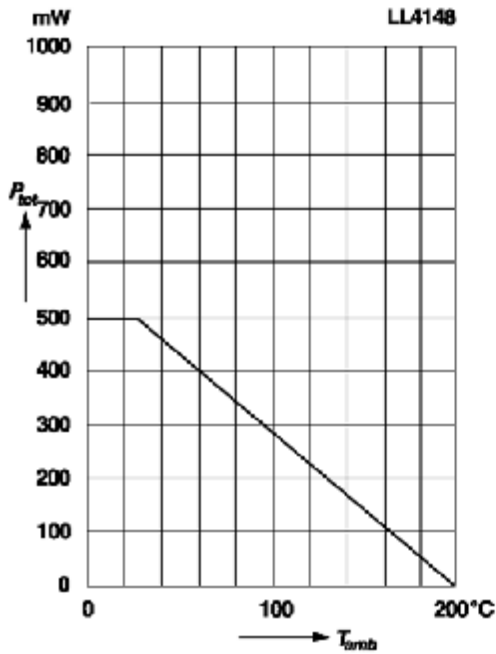

Relative capacitance versus reverse voltage

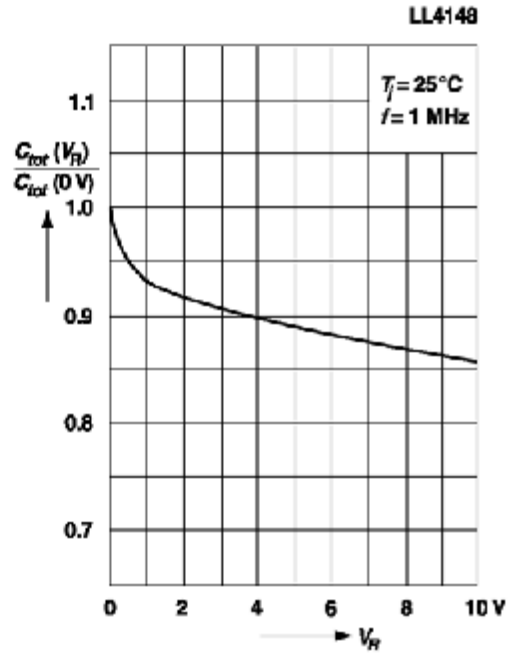



Leakage current versus junction temperature

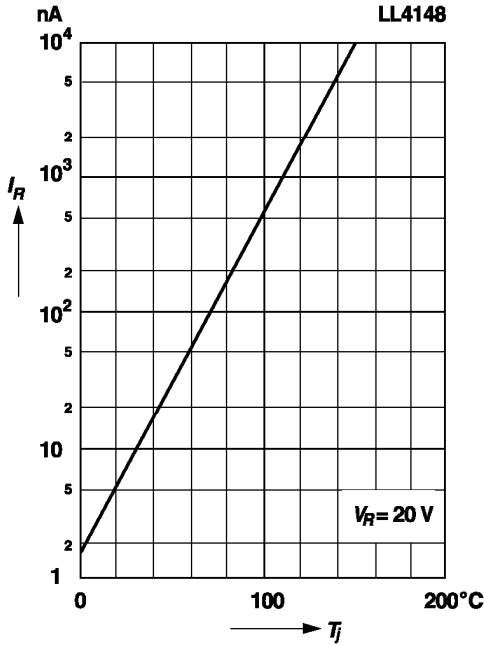

Rectification Efficiency Measurement Circuit

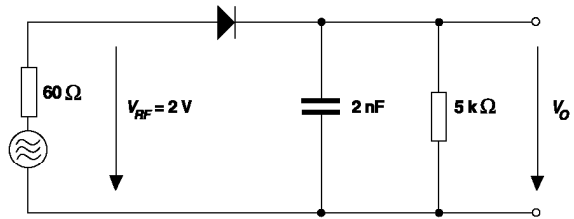

Admissible repetitive peak forward current versus pulse duration

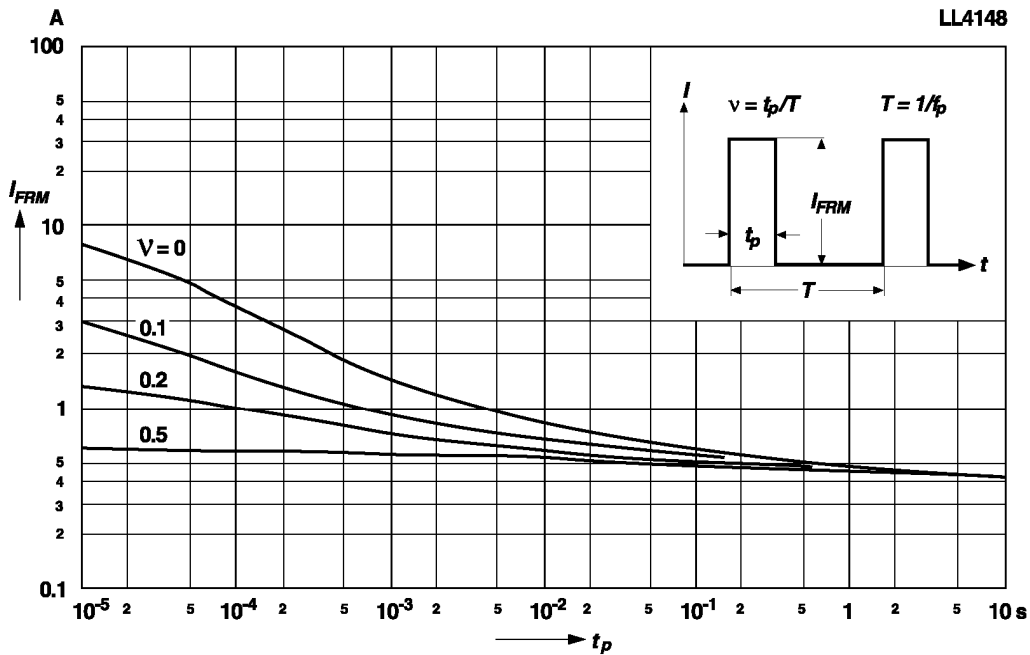

Valid provided that electrodes are kept at ambient temperature





苏州固锴电子股份有限公司
SUZHOU GOODARK ELECTRONICS CO., LTD

6. LABEL SPEC

Packa ge	Size of reel, inner box	Content of reel & inner box	Size of outer carton	Content of outer carton
Mini melf/S OD80	65*30mm 	DEVICE QTY LOT NO QC	101*76mm 	DEVICE CASE QTY DATE CO/NO N.W. P/O NO QA G.W.
	100*60mm 	DEVICE CASE QTY LOT NO QC		

7. PACKING SPEC

	Size 尺寸	Qty	Illustration	
Inner box	194*185*120	25,000pcs /inner box	 10 reels	 Appearance
Outer carton	395*265*223	100,000pcs /Outer carton	 4 inner boxes	 Appearance



8. THE RECOMMENDATION FOR REFLOW SOLDERING CONDITION

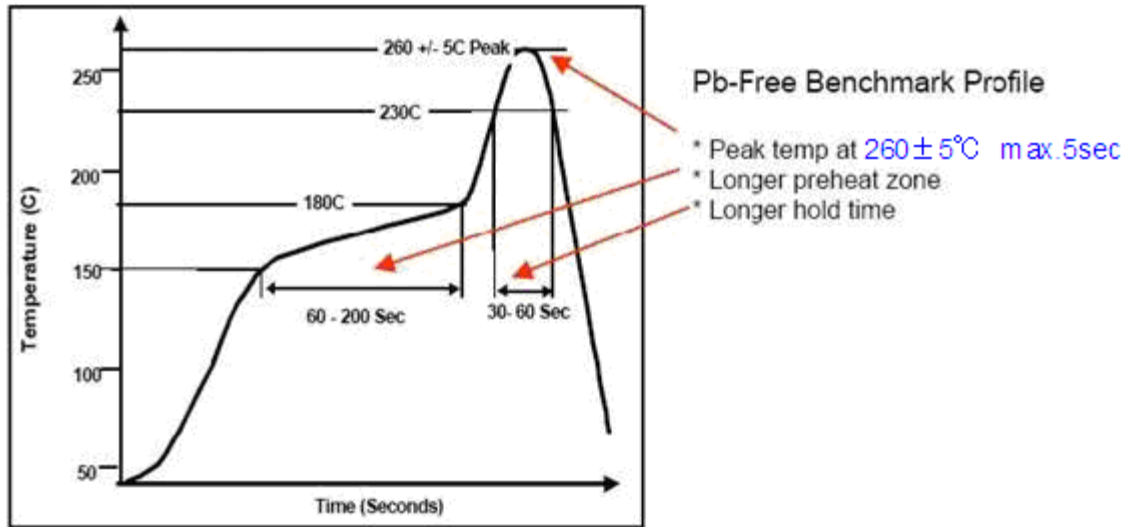

9. DATABOOK REFERENCE

The following data references are available for this device:

1. Good-Ark Databook
2. Applications Notes
3. Internet homepage: <http://www.goodark.com/>

Reference Address

All enquiries relating to this document should be addressed to the following:

Good-Ark Electronics Co., Ltd.

19F Metropolitan Towers, 199 Shishan Rd.

Suzhou New District, 215011 P.R.China

Phone : + 86 512-68188888

Fax : + 86 512 68181222

10. SVHC compliant

We here state that this device is compliant with the current SVHC list in REACH Regulation.

Details as below.



苏州固得电子股份有限公司
SUZHOU GOODARK ELECTRONICS CO., LTD

No	Substance Name	CAS NO	EC NO	Application	Remark
1	Anthracene	120-12-7			<1000PPM
2	4,4'-Diaminodiphenylmethane	101-77-9			<1000PPM
3	Dibutyl phthalate	84-74-2		Plasticizer, etc	<1000PPM
4	Hexabromocyclododecane(HBCDD)	25637-99-4		Flame retardant	<1000PPM
5	Cobalt dichloride	7646-79-9		Humidity Indicator	<1000PPM
6	Diasenic pentaoxide	1303-28-2			<1000PPM
7	Diasenic trioxide	1327-53-3			<1000PPM
8	Sodium dichromate dehydrate	7789-12-0			<1000PPM
9	5-tert-butyl-2,4,6-trinitro-m-xylene (musk xylene)	81-15-2		Aroma	<1000PPM
10	Bis (2-ethyl(hexyl)phthalate)(DEHP)	117-81-7		Plasticizer, etc	<1000PPM
11	Alkanes, C10-13, chloro (Short Chain Chlorinated Paraffins)	85535-84-8		Plasticizer, etc	<1000PPM
12	Bis(tributyltin)oxide	56-35-9		Insecticide etc	<1000PPM
13	Lead hydrogen arsenate	7784-40-9			<1000PPM
14	Triethyl arsenate	15606-95-8			<1000PPM
15	Benzyl butyl phthalate	85-68-7		Plasticizer, etc	<1000PPM
16	Anthracene oil	90640-80-5	292-602-7		<1000PPM
17	Anthracene oil, anthracene paste, distn, lights	91995-17-4	295-278-5		<1000PPM
18	Anthracene oil, anthracene paste, anthracene fraction	91995-15-2	295-275-9		<1000PPM
19	Anthracene oil, anthracene-low	90640-82-7	292-603-2		<1000PPM
20	Anthracene oil, anthracene paste	90640-81-6	292-604-8		<1000PPM
21	Coal tar pitch, high temperature	65996-93-2	266-028-2		<1000PPM
22	Acrylamide	1979-6-1	201-173-7		<1000PPM
23	Aluminosilicate, Refractory Ceramic Fibers		650-017-00-8**		<1000PPM
24	Zirconia Aluminosilicate, Refractory Ceramic Fibres		650-017-00-8**		<1000PPM
25	2,4-Dinitrotoluene	121-14-2	204-450-0		<1000PPM
26	Diisobutyl phthalate	84-69-5	201-553-2		<1000PPM
27	Lead chromate	7758-97-6	231-846-0		<1000PPM
28	Lead chromate molybdate sulphate red (C.I. Pigment Red 104)	12656-85-8	235-759-9		<1000PPM
29	Lead sulfochromate yellow (C.I. Pigment Yellow 34)	1344-37-2	215-693-7		<1000PPM
30	Tris(2-chloroethyl) phosphate	115-96-8	204-118-5		<1000PPM
31	Trichloroethylene	1979-1-6	201-167-4		<1000PPM
32	Boric acid	10043-35-3	233-139-2		<1000PPM
		11113-50-1	234-343-4		<1000PPM
33	Disodium tetraborate, anhydrous	1330-43-4	215-540-4		<1000PPM
		12179-04-3			<1000PPM
		1303-96-4			<1000PPM
34	Tetraboron disodium heptaoxide, hydrate	12267-73-1	235-541-3		<1000PPM
35	Sodium chromate	7775-11-3	231-889-5		<1000PPM
36	Potassium chromate	7789-00-6	232-140-5		<1000PPM
37	Ammonium dichromate	7789-9-5	232-143-1		<1000PPM
38	Potassium dichromate	7778-50-9	231-906-6		<1000PPM
39	Cobalt sulphate	10124-43-3	233-334-2		<1000PPM
40	Cobalt dinitrate	10141-05-6	233-402-1		<1000PPM
41	Cobalt carbonate	513-79-1	208-169-4		<1000PPM



苏州固锴电子股份有限公司
SUZHOU GOODARK ELECTRONICS CO., LTD

No	Substance Name	CAS NO	EC NO	Application	Remark
42	Cobalt diacetate	71-48-7	200-755-8		<1000PPM
43	2-Methoxyethanol	109-86-4	203-713-7		<1000PPM
44	2-Ethoxyethanol	110-80-5	203-804-1		<1000PPM
45	Trioxochromium	1333-82-0	215-607-8		<1000PPM
46	Acids generated from chromium trioxide and their oligomers:	Chromic acid	7738-94-5	231-801-5	<1000PMM
		Dichromic acid	13530-68-2	236-881-5	<1000PMM
		Oligomers of chromic acid and dichromic acid	-	-	<1000PMM
47	2-ethoxyethyl acetate	111-15-9	203-839-2		<1000PPM
48	Strontium Chromate	7789-6-2	232-142-6		<1000PPM
49	(1,2-benzenedicarboxylic Acid, di-C7-11-branched and Linear Alkyl Esters)	68515-42-4	271-084-6		<1000PPM
50	Hydrazine	7803-57-8	206-114-9		<1000PPM
		302-01-2			
51	1-methyl-2-pyrrolidone	872-50-4	212-828-1		<1000PPM
52	(1,2,3-trichloropropane)	96-18-4	202-486-1		<1000PPM
53	(1,2-benzenedicarboxylic Acid, di-C6-8-branched Alkyl Esters, C7-rich)	71888-89-6	276-158-1		<1000PPM
54	Dichromium tris(chromate)	24613-89-6	246-356-2		<1000PPM
55	Potassium hydroxyoctaoxidizincatedi-chromate	11103-86-9	234-329-8		<1000PPM
56	Pentazinc chromate octahydroxide	49663-84-5	256-418-0		<1000PPM
57	Aluminosilicate Refractory Ceramic Fibres (RCF)	-	-		<1000PPM
58	Zirconia Aluminosilicate Refractory Ceramic Fibres (Zr-RCF)	-	-		<1000PPM
59	Formaldehyde, oligomeric reaction products with aniline (technical MDA)	25214-70-4	500-036-1		<1000PPM
60	Bis(2-methoxyethyl) phthalate	117-82-8	204-212-6		<1000PPM
61	2-Methoxyaniline; o-Anisidine	90-04-0	201-963-1		<1000PPM
62	4-(1,1,3,3-tetramethylbutyl)phenol, (4-tert-Octylphenol)	140-66-9	205-426-2		<1000PPM
63	1,2-Dichloroethane 1, 2	107-06-2	203-458-1		<1000PPM
64	Bis(2-methoxyethyl) ether	111-96-6	203-924-4		<1000PPM
65	Arsenic acid	7778-39-4	231-901-9		<1000PPM
66	Calcium arsenate	7778-44-1	231-904-5		<1000PPM
67	Trilead diarsenate	3687-31-8	222-979-5		<1000PPM
68	N,N-dimethylacetamide (DMAC) N, N	127-19-5	204-826-4		<1000PPM
69	2,2'-dichloro-4,4'-methylenedianiline (MOCA) 4, 4'	101-14-4	202-918-9		<1000PPM
70	Phenolphthalein	1977-9-8	201-004-7		<1000PPM
71	Lead azide Lead diazide	13424-46-9	236-542-1		<1000PPM
72	Lead styphnate	15245-44-0	239-290-0		<1000PPM
73	Lead dipicrate	6477-64-1	229-335-2		<1000PPM

X-ON Electronics

Largest Supplier of Electrical and Electronic Components

Click to view similar products for [Diodes - General Purpose, Power, Switching category:](#)

Click to view products by [Good-Ark manufacturer:](#)

Other Similar products are found below :

[MMBD3004S-13-F](#) [RD0306T-H](#) [DSE010-TR-E](#) [BAV17-TR](#) [BAV19-TR](#) [1N3611](#) [NTE156A](#) [NTE574](#) [NTE6244](#) [1SS181-TP](#) [1SS193,LF](#)
[1SS400CST2RA](#) [SDAA13](#) [SHN2D02FUTW1T1G](#) [LS4151GS08](#) [FC903-TR-E](#) [1N4449](#) [1N456A](#) [1N4934-E3/73](#) [1N914B](#) [1N914BTR](#)
[1SS226-TP](#) [RFUH20TB3S](#) [D291S45T](#) [BAV300-TR](#) [BAW56DWQ-7-F](#) [BAW75-TAP](#) [MM230L-CAA](#) [IDW40E65D1](#) [JAN1N3600](#) [LL4151-](#)
[GS18](#) [053684A](#) [SMMSD4148T3G](#) [707803H](#) [NSVDAN222T1G](#) [CDSZC01100-HF](#) [LL4150-M-08](#) [1N4454-TR](#) [BAV199E6433HTMA1](#)
[BAS28-7](#) [BAW56HDW-13](#) [BAS28 TR](#) [VS-HFA04SD60STR-M3](#) [NSVM1MA152WKT1G](#) [RGP30D-E3/73](#) [BAV99TQ-13-F](#) [BAS21DWA-7](#)
[NTE6250](#) [NTE582-4](#) [NTE582-6](#)