

FEATURES

- Maximum output current
 $I_{OM}: 0.1A$
- Output voltage
 $V_O: 5V$
- Continuous total dissipation
 $P_D: 0.6 W (T_a = 25 ^\circ C)$

SOT-89-3L

- 1. OUT
- 2. GND
- 3. IN

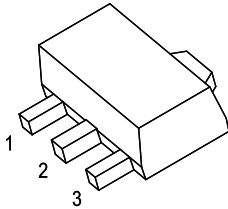

SOT-89 PACKAGE OUTLINE

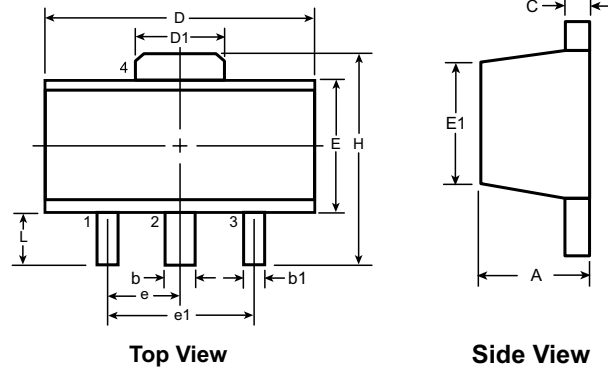

Symbol	A	b	b1	C	D	D1	E	E1	e	e1	H	L
Dimensions (mm)	MIN	1.40	0.44	0.36	0.3	4.40	1.50	2.29	2.00'	1.50 BSC	3.94	0.89
	NOM	-	-	-	-	-	-	-	-	3.00 BSC	-	-
	MAX	1.60	0.56	0.48	0.5	4.60	1.75	2.60	2.29	-	4.25	1.20

Dimensions in mm

ABSOLUTE MAXIMUM RATINGS (Operating temperature range applies unless otherwise specified)

Parameter	Symbol	Value	Unit
Input Voltage	V_i	30	V
Thermal Resistance from Junction to Ambient	$R_{\theta JA}$	160	$^\circ C/W$
Operating Junction Temperature Range	T_{OPR}	-40~+125	$^\circ C$
Storage Temperature Range	T_{STG}	-65~+150	$^\circ C$

78L05

ELECTRICAL CHARACTERISTICS AT SPECIFIED VIRTUAL JUNCTION TEMPERATURE ($V_i=10V, I_o=40mA, C_i=0.33\mu F, C_o=0.1\mu F$, unless otherwise specified)

Parameter	Symbol	Test conditions	Min	Typ	Max	Unit	
Output voltage	V_o		25°C	4.80	5.0	5.20	V
				4.85	5.0	5.15	V
				4.90	5.0	5.10	V
		7V ≤ V_i ≤ 20V, $I_o=1mA \sim 40mA$	0-125°C	4.75	5.0	5.25	V
				4.75	5.0	5.25	V
Load Regulation	ΔV_o	$I_o=1mA \sim 100mA$	25°C	15	60	mV	
		$I_o=1mA \sim 40mA$	25°C	8	30	mV	
Line regulation	ΔV_o	7V ≤ V_i ≤ 20V	0-125°C	32	150	mV	
		8V ≤ V_i ≤ 20V	25°C	26	100	mV	
Quiescent Current	I_q		25°C	3.8	6	mA	
Quiescent Current Change	ΔI_q	8V ≤ V_i ≤ 20V	0-125°C		1.5	mA	
	ΔI_q	1mA ≤ V_i ≤ 40mA	0-125°C		0.1		
Output Noise Voltage	V_N	10Hz ≤ f ≤ 100KHz	25°C	42		$\mu V/V_o$	
Ripple Rejection	RR	8V ≤ V_i ≤ 20V, $f=120Hz$	0-125	41	49	dB	
Dropout Voltage	V_d		25°C	1.7		V	

* Pulse test.

TYPICAL APPLICATION

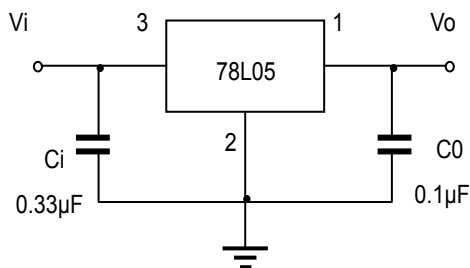

Note: Bypass capacitors are recommended for optimum stability and transient response and should be located as close as

RATING AND CHARACTERISTIC CURVES (78L05)

Output Characteristics

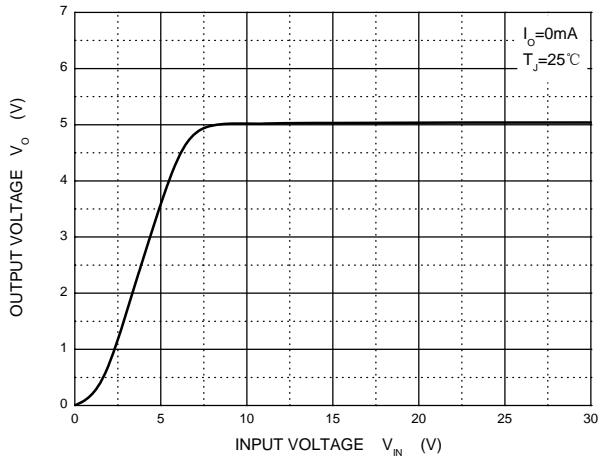

Dropout Characteristics

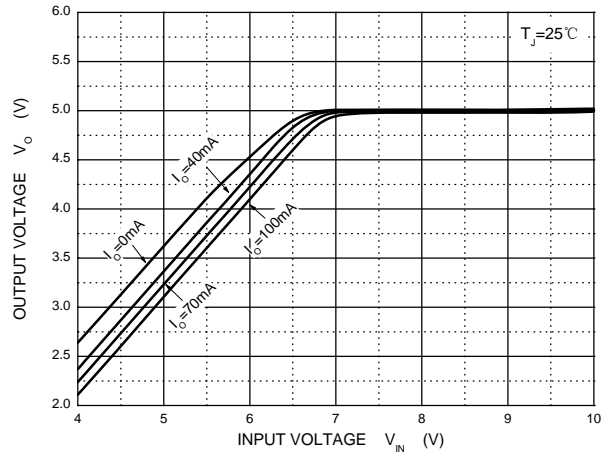

Quiescent Current vs Input Voltage

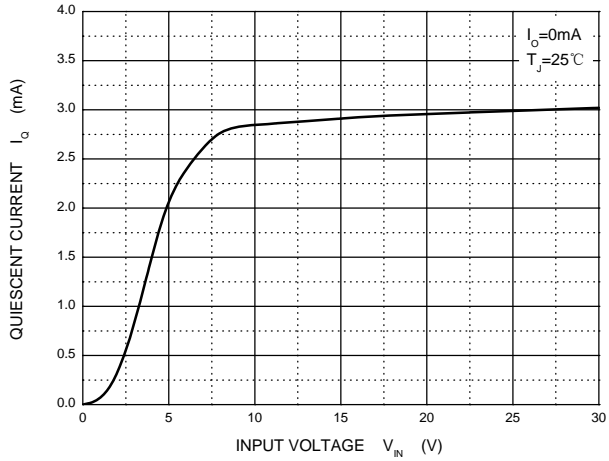

Current Cut-off Grid Voltage

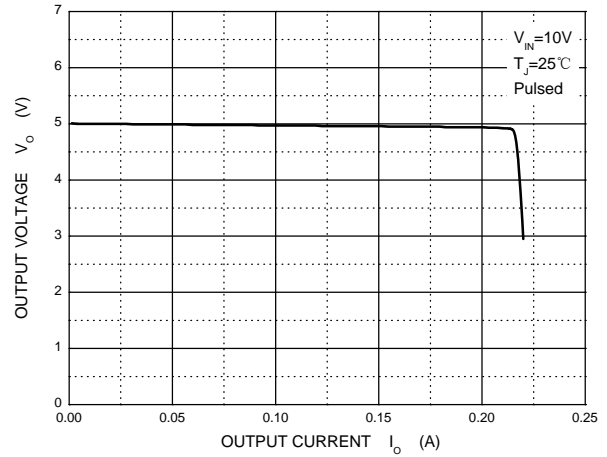

Output Voltage vs Junction Temperature

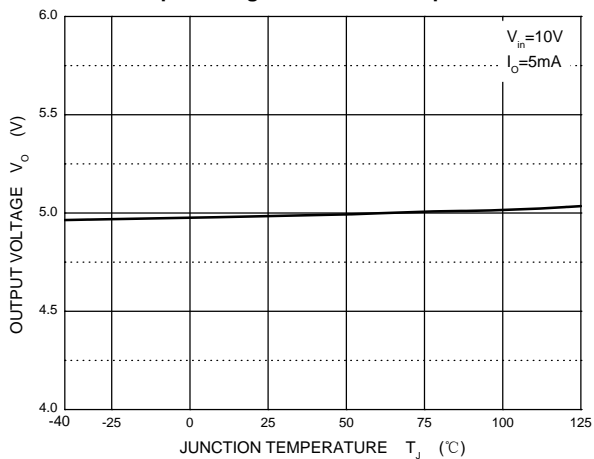

Power Derating Curve

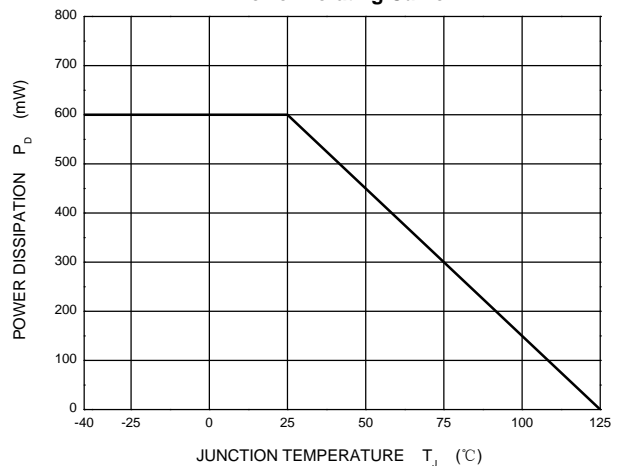

X-ON Electronics

Largest Supplier of Electrical and Electronic Components

Click to view similar products for [Linear Voltage Regulators](#) category:

Click to view products by [GOODWORK](#) manufacturer:

Other Similar products are found below :

[LV56831P-E](#) [LV5684PVD-XH](#) [MCDTSA6-2R](#) [L7815ACV-DG](#) [PQ3DZ53U](#) [LV56801P-E](#) [TLE42794G](#) [L78L05CZ/1SX](#) [L78LR05DL-MA-E](#) [636416C](#) [714954EB](#) [BA033LBSG2-TR](#) [LV5680P-E](#) [L78M15CV-DG](#) [L79M05T-E](#) [TLS202A1MBVHTSA1](#) [L78LR05D-MA-E](#) [NCV317MBTG](#) [NTE7227](#) [LV5680NPVC-XH](#) [LT1054CN8](#) [MP2018GZD-5-Z](#) [MP2018GZD-33-Z](#) [MIC5281-3.3YMM](#) [MC78L06BP-AP](#) [TA48LS05F\(TE85L,F\)](#) [TA78L12F\(TE12L,F\)](#) [TC47BR5003ECT](#) [TCR2LN12,LF\(S](#) [TCR2LN28,LF\(S](#) [TCR2LN30,LF\(S](#) [TCR3DF295,LM\(CT](#) [TCR3DF40,LM\(CT](#) [BA178M20CP-E2](#) [L78M12ABDT](#) [LM7812SX/NOPB](#) [LR645N3-G-P003](#) [LR645N3-G-P013](#) [ZXTR2005P5-13](#) [SCD7812BTG](#) [TCR3DF335,LM\(CT](#) [ZXTR2012K-13](#) [TLE42994E V33](#) [ZXTR2008K-13](#) [ZXTR2005K-13](#) [L88R05DL-E](#) [ADP3300ARTZ-2.7RL7](#) [LM120K-15/883](#) [IFX54441LDVXUMA1](#) [LM317D2T-TR](#)