



SMF05C

Features

- ◇ 100W (8/20 μ s) Peak Pulse Power ◇
- ESD and Latch-Up Protection
- ◇ SOT-363 Package
- ◇ RoHS Compliant
- ◇ Matte Tin Lead finish (Pb-Free) ◇
- Protect Five I/O Lines
- ◇ Meet IEC61000-4-2 Level 4:
 - Contact Discharge > 20kV Air
 - Discharge > 20kV

Applications

- ◇ Peripherals
- ◇ Audio Players
- ◇ Digital Cameras
- ◇ Cordless Phones
- ◇ Portable Instrumentation
- ◇ Notebooks and Handhelds
- ◇ Personal Digital Assistants (PDA's)
- ◇ Cellular Handsets and Accessories

Ordering information

Device	Package	Making
SMF05C	SOT-363	5C

Circuit Diagram

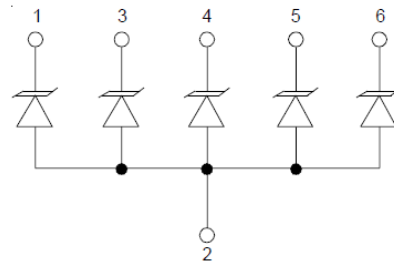

PIN Diagram

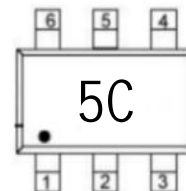
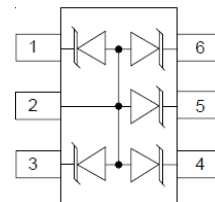

Maximum Ratings (Ta = 25°C)

Symbol	Parameter	Value	Unit
PPK	Peak Pulse Power	100	W
IPP	Peak Pulse Current	6	A
VESD (Contact)	Contact ESD Voltage per IEC61000-4-2	20	kV
VESD (Air)	Air ESD Voltage per IEC61000-4-2	20	kV
TJ	Junction Temperature	-55 to +125	°C
TSTG	Storage Temperature	-55 to +150	°C

SMF05C

Portion Electronics Parameter

Symbol	Parameter
IT	Test Current
IPP	Maximum Reverse Peak Pulse Current
Vc	Clamping Voltage @Ic

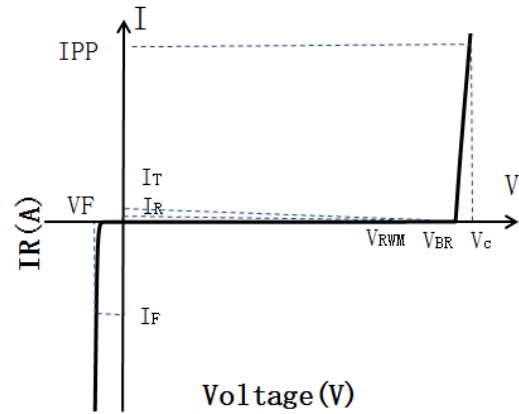

Electrical Characteristics (Ta = 25°C)

Symbol	Parameter	Conditions	Min	Typ	Max	Unit
VRWM	Reverse Working Peak Voltage				5	V
VBR	Reverse Breakdown Voltage	IT = 1mA	6		8	V
IR	Reverse Leakage Current	VRWM = 5V			5	μ A
VC	Clamping Voltage	IPP = 1A (8/20 μ s)			10	V
VC	Clamping Voltage	IPP = 6A (8/20 μ s)			18	V
CJ	Capacitance	VR = 0V, f = 1MHz		50		pF

RATING AND CHARACTERISTIC CURVES (SMF05C)

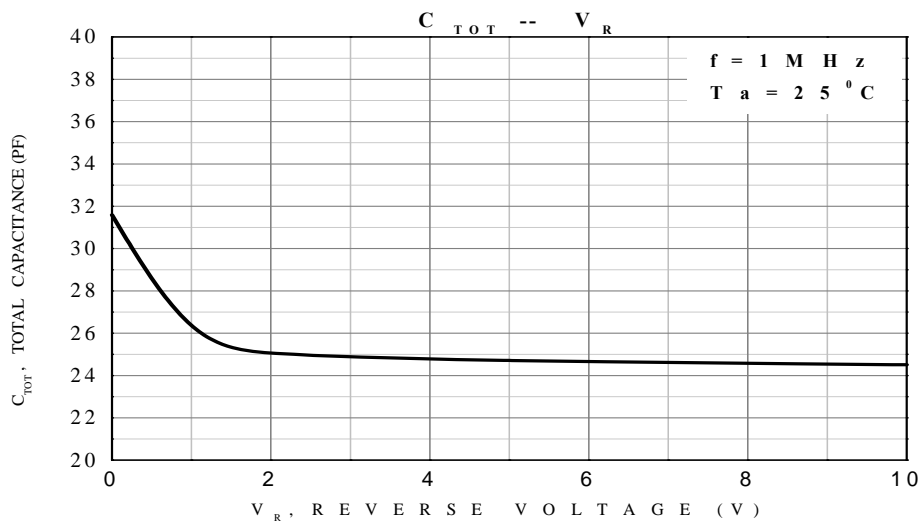
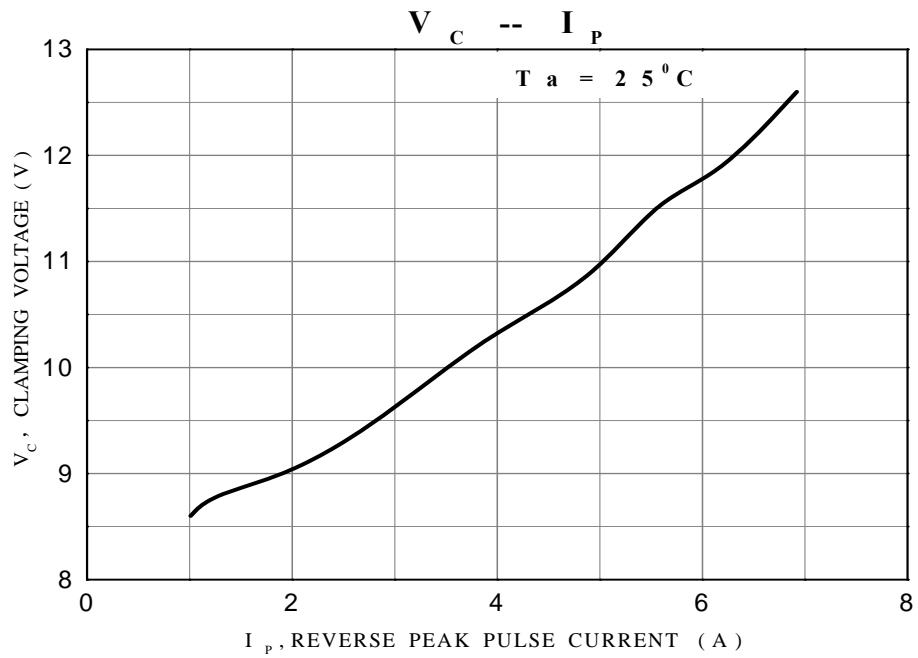

SOT-363 PACKAGE OUTLINE DIMENSIO

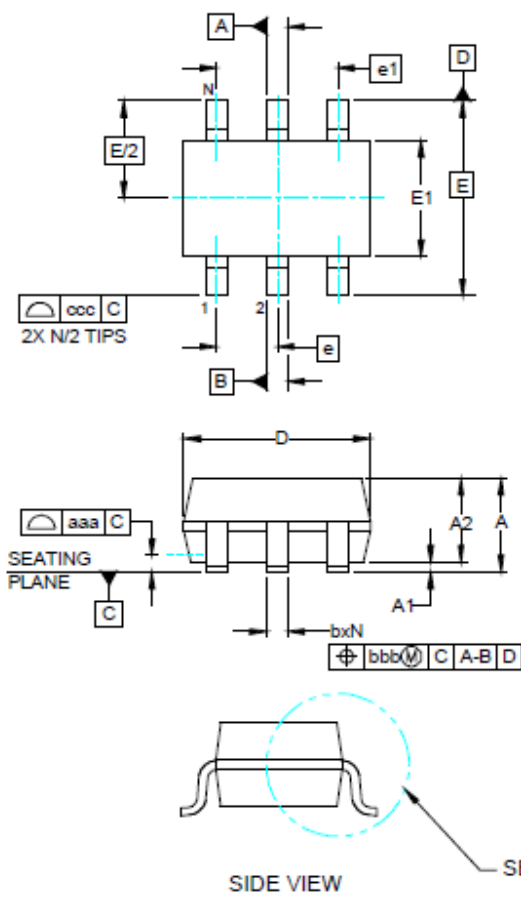

DIM	INCHES			MILLIMETERS		
	MIN	NOM	MAX	MIN	NOM	MAX
A	-	-	.043	-	-	1.10
A1	.000	-	.004	0.00	-	0.10
A2	.028	.035	.039	0.70	0.90	1.00
b	.008	-	.012	0.15	-	0.30
c	.003	-	.009	0.08	-	0.22
D	.071	.079	.087	1.80	2.00	2.20
E1	.045	.049	.053	1.15	1.25	1.35
E	.083 BSC			2.10 BSC		
e	.028 BSC			0.65 BSC		
e1	.051			1.30 BSC		
L	.010	.014	.018	0.26	0.36	0.46
L1	(.017)			(0.42)		
N	6			6		
θ_1	0°	-	8°	0°	-	8°
aaa	.004			0.10		
bbb	.004			0.10		
occ	.012			0.30		

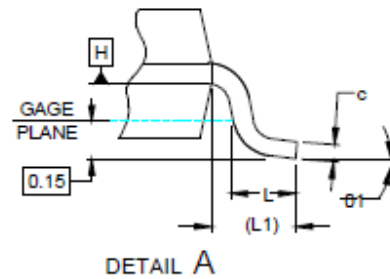

X-ON Electronics

Largest Supplier of Electrical and Electronic Components

Click to view similar products for [ESD Suppressors / TVS Diodes](#) category:

Click to view products by [GOODWORK](#) manufacturer:

Other Similar products are found below :

[60KS200C](#) [D18V0L1B2LP-7B](#) [D5V0F4U5P5-7](#) [NTE4902](#) [P4KE27CA](#) [P6KE11CA](#) [P6KE8.2A](#) [SA60CA](#) [SA64CA](#) [SMBJ12CATR](#)
[SMBJ33CATR](#) [SMBJ6.5A](#) [SMBJ8.0A](#) [ESD101-B1-02ELS E6327](#) [ESD112-B1-02EL E6327](#) [ESD7451N2T5G](#) [19180-510](#) [CPDT-5V0USP-](#)
[HF](#) [3.0SMCJ33CA-F](#) [3.0SMCJ36A-F](#) [HSPC16701B02TP](#) [JANTX1N6126A](#) [D3V3Q1B2DLP3-7](#) [D55V0M1B2WS-7](#) [SCM1293A-04SO](#)
[ESD200-B1-CSP0201 E6327](#) [SM12-7](#) [CEN955 W/DATA](#) [VESD12A1A-HD1-GS08](#) [CPDQC5V0-HF](#) [D1213A-01LP4-7B](#) [ESD101-B1-02EL](#)
[E6327](#) [AOZ8808DI-03](#) [5KP15A](#) [5KP48A](#) [5KP90A](#) [ESD3V3D7-TP](#) [15KPA36A-LF](#) [P4KE56CA](#) [P4KE68A](#) [P4KE91CATR](#) [P6KE120A](#)
[P6KE13CA](#) [P6KE43CA](#) [P6KE6.8CA](#) [P6KE8.2](#) [P6SMBJ20CA](#) [JANTX1N6072A](#) [SR2835ESKG](#) [SA90CA](#)