



FEATURES

- NPN epitaxial silicon, planar design.
- Collector-emitter voltage $V_{CE}=25V$.
- Collector current $I_C=1.5A$.
- Transition frequency $f_T > 100MHz$ @ $I_C=50mA_{dc}$, $V_{CE}=10V_{dc}$, $f=30MHz$.
- In compliance with EU RoHS 2002/95/EC directives.



MECHANICAL DATA

Case: SOT-23, Plastic

Terminals: Solderable per MIL-STD-750, method 2026

Approx. Weight: 0.008gram

Marking: Y1

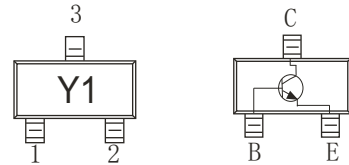

RANK	L	H	J
RANGE	120-200	200-350	300-400

MAXIMUM RATINGS ($T_a=25^{\circ}C$ unless otherwise noted)

Symbol	Parameter	Value	Unit
V_{CBO}	Collector-Base Voltage	40	V
V_{CEO}	Collector-Emitter Voltage	25	V
V_{EBO}	Emitter-Base Voltage	5	V
I_C	Collector Current	1.5	A
P_C	Total Device Dissipation	0.3	W
$R_{\theta JA}$	Thermal Resistance Form Junction to Ambient	625	$^{\circ}C/W$
T_J	Junction Temperature	150	$^{\circ}C$
T_{STG}	Storage Temperature	-55~+150	$^{\circ}C$

SS8050

ELECTRICAL CHARACTERISTICS (Ta=25°C unless otherwise specified)

Parameter	Symbol	Test Condition	Min.	Typ.	Max.	Units
Collector-Base breakdown voltage	$V_{(BR)CBO}$	$I_C=100\mu A, I_E=0$	40			V
Collector-Emitter breakdown voltage	$V_{(BR)CEO}$	$I_C=1mA, I_B=0$	25			V
Emitter-Base breakdown voltage	$V_{(BR)EBO}$	$I_E=100\mu A, I_C=0$	5			V
Collector cut-off current	I_{CBO}	$V_{CB}=40V, I_C=0$			0.1	μA
Collector cut-off current	I_{CEX}	$V_{CE}=20V, I_B=0$			0.1	μA
Base cut-off current	I_{BEX}				0.1	μA
Emitter cut-off current	I_{EBO}	$V_{EB}=5V, I_C=0$			0.1	μA
DC current gain*	H_{FE}	$I_C=0.1mA, V_{CE}=1.0V$	40			
	H_{FE}	$I_C=1mA, V_{CE}=1.0V$	70			
	H_{FE}	$I_C=100mA, V_{CE}=1.0V$	100		400	
	H_{FE}	$I_C=400mA, V_{CE}=1.0V$	60			
	H_{FE}	$I_C=800mA, V_{CE}=1.0V$	30			
Collector-Emitter saturation voltage	$V_{CE(SAT)}$	$I_C=800mA, I_B=80mA$			0.5	V
		$I_C=500mA, I_B=50mA$			0.6	V
Base-Emitter Saturation voltage*	$V_{BE(SAT)}$	$I_C=100mA, I_B=10mA$			1.1	V
		$I_C=800mA, I_B=80mA$			1.2	V
Input capacitance	C_{IB}	$V_{CB}=5V, I_E=0, f=1MHz$			4.0	pF
Output capacitance	C_{OB}	$V_{EB}=0.5V, I_C=0, f=1MHz$			8.0	pF
Transition frequency	f_T	$I_C=50mA, V_{CE}=10V, f=30MHz$	100			MHz
Delay time	t_d	$V_{CC}=3V, V_{BE}=-0.5V,$ $I_C=10mA, I_B=1.0mA$			35	nS
Rise time	t_r				35	nS
Storage time	t_s	$V_{CC}=3V, V_{BE}=-0.5V,$ $I_{B1}=I_{B2}=1.0mA$			200	nS
Fall time	t_f				50	nS

*Pulse Test: Pulse Width<300uS, Duty Cycle<2.0%.

SS8050

ELECTRICAL CHARACTERISTICS ($T_a=25^\circ\text{C}$ unless otherwise specified)

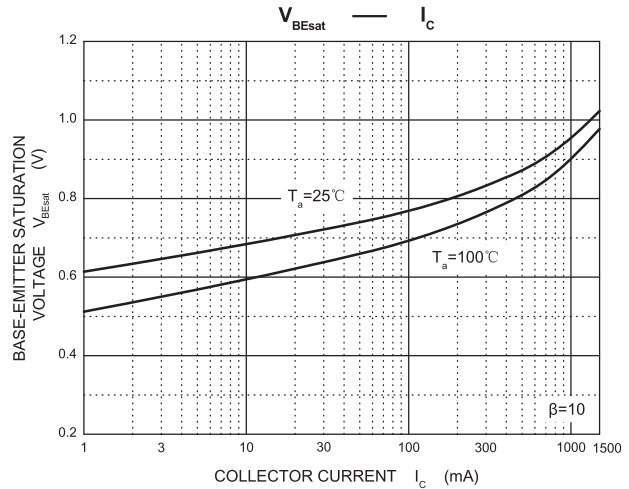
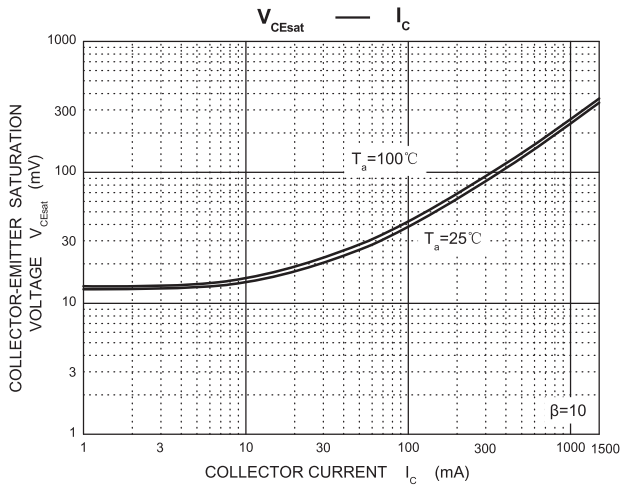
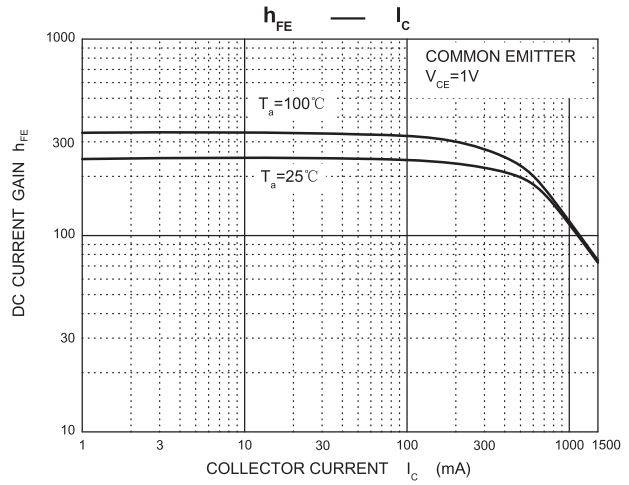
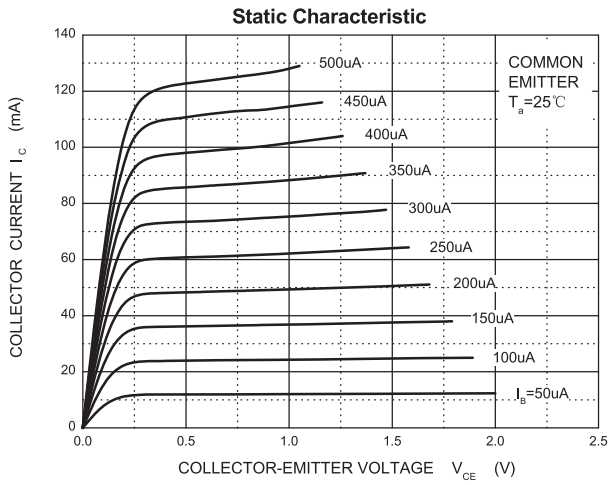

SS8050

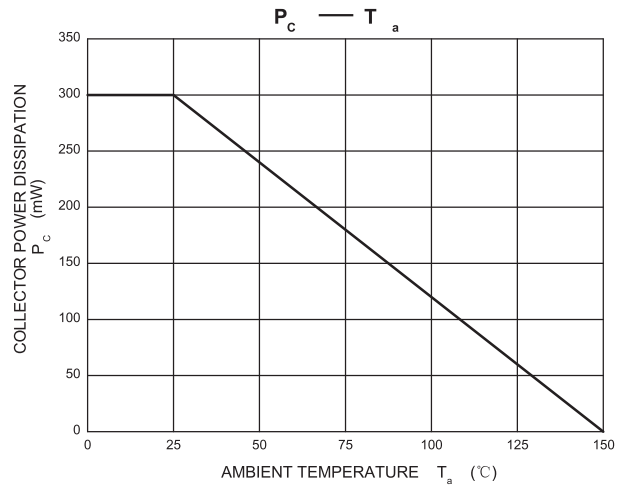
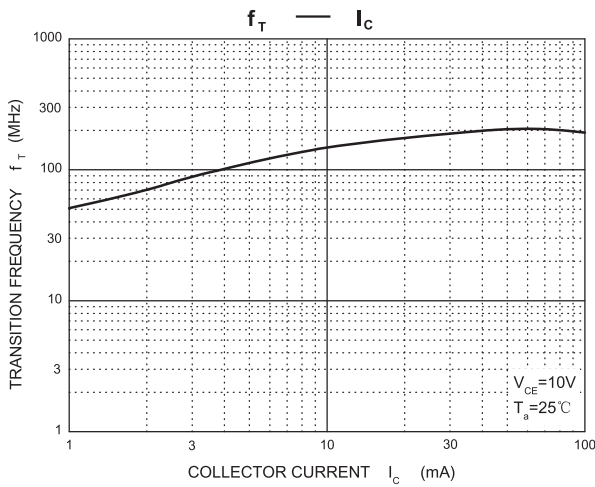
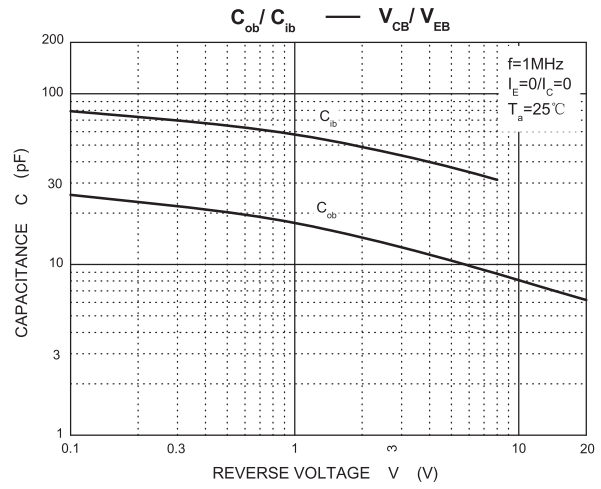
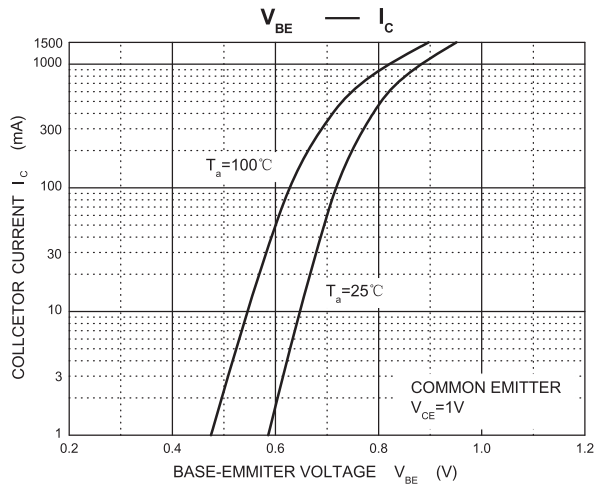

SOT-23 OUTLINE DIMENSIONS

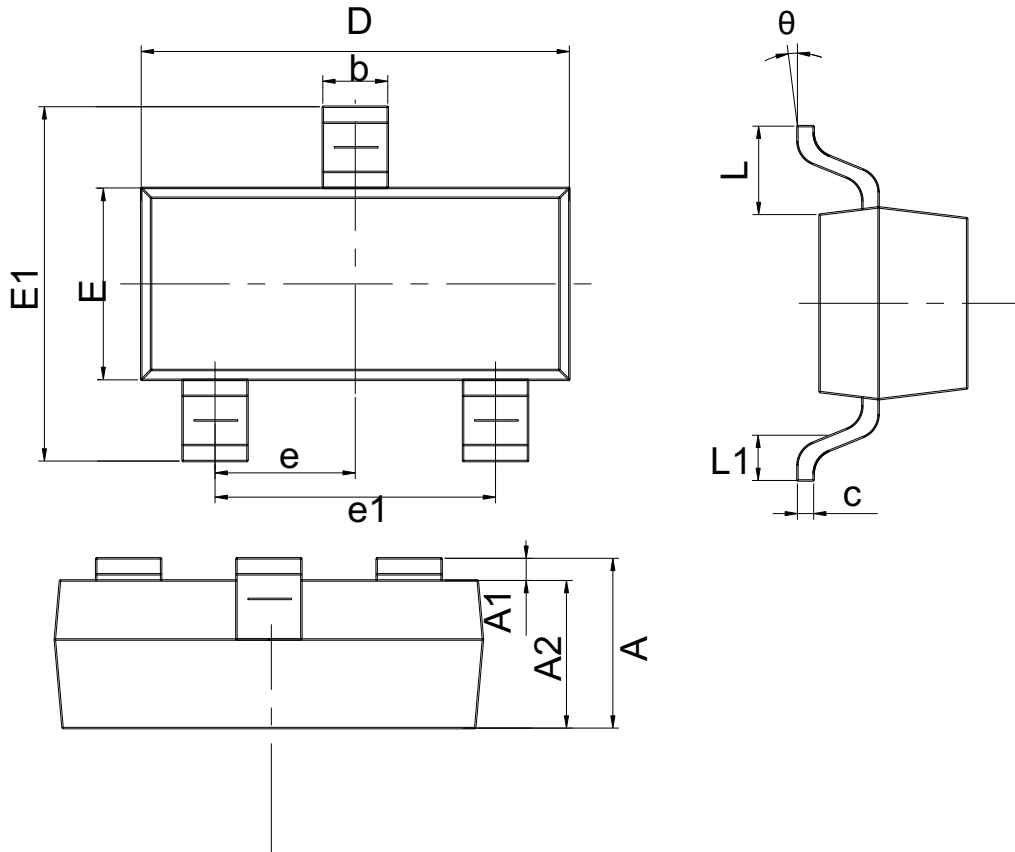

symbol	Dimensions In Millimeters		Dimensions In Inches	
	Min.	Max.	Min.	Max.
A	0.900	1.150	0.035	0.045
A1	0.000	0.100	0.000	0.004
A2	0.900	1.050	0.035	0.041
b	0.300	0.500	0.012	0.020
c	0.080	0.150	0.003	0.006
D	2.800	3.000	0.110	0.118
E	1.200	1.400	0.047	0.055
E1	2.250	2.550	0.089	0.100
e	0.950REF.		0.037REF.	
e1	1.800	2.000	0.071	0.079
L	0.550REF		0.022REF	
L1	0.300	0.500	0.012	0.020
θ	0°	8°	0°	8°

SOT-23 Tape and reel

SOT-23 Embossed Carrier Tape

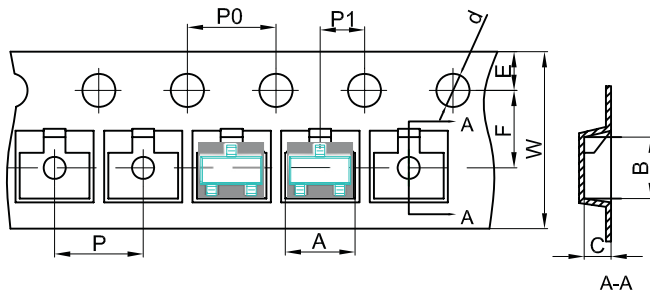

Packaging Description:

SOT-23 parts are shipped in tape. The carrier tape is made from a dissipative (carbon filled) polycarbonate resin. The cover tape is a multilayer film (Heat Activated Adhesive in nature) primarily composed of polyester film, adhesive layer, sealant, and anti-static sprayed agent. These reeled parts in standard option are shipped with 3000 units per 7" or 17.8cm diameter reel. The reels are clear in color and is made of polystyrene plastic (anti-static coated).

Dimensions are in millimeter										
Pkg type	A	B	C	d	E	F	P0	P	P1	W
SOT-23	3.15	2.77	1.22	Ø1.50	1.75	3.50	4.00	4.00	2.00	8.00
(Tolerance)	+/-0.1	+/-0.1	+/-0.1	+/-0.1	+/-0.1	+/-0.1	+/-0.1	+/-0.1	+/-0.1	+0.3/-0.1

SOT-23 Tape Leader and Trailer

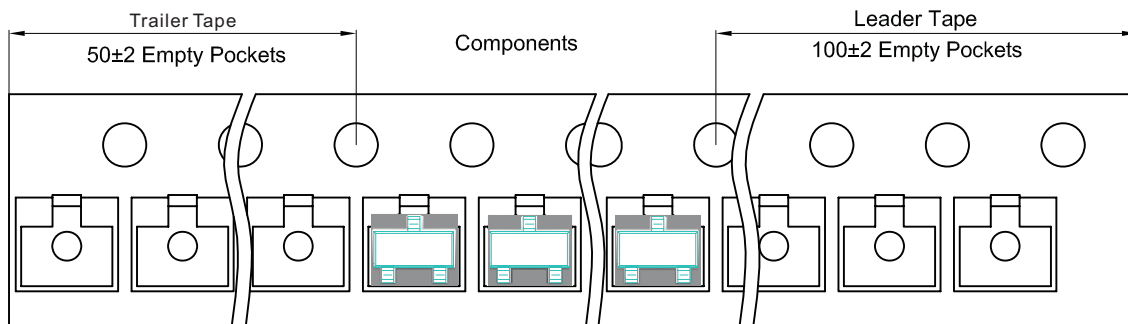

SOT-23 Reel

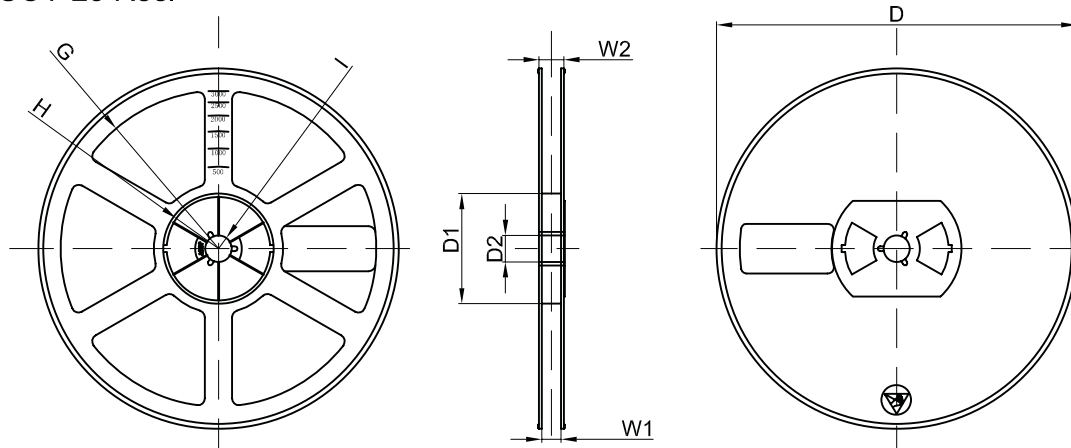

Dimensions are in millimeter								
Reel Option	D	D1	D2	G	H	I	W1	W2
7" Dia	Ø178.00	54.40	13.00	R78.00	R25.60	R6.50	9.50	12.30
Tolerance	+/-2	+/-1	+/-1	+/-1	+/-1	+/-1	+/-1	+/-1

REEL	Reel Size	Box	Box Size(mm)	Carton	Carton Size(mm)	G.W.(kg)
3000 pcs	7 inch	45,000 pcs	210x208x203	180,000 pcs	440x440x230	8.45

SOT-23 Pad size

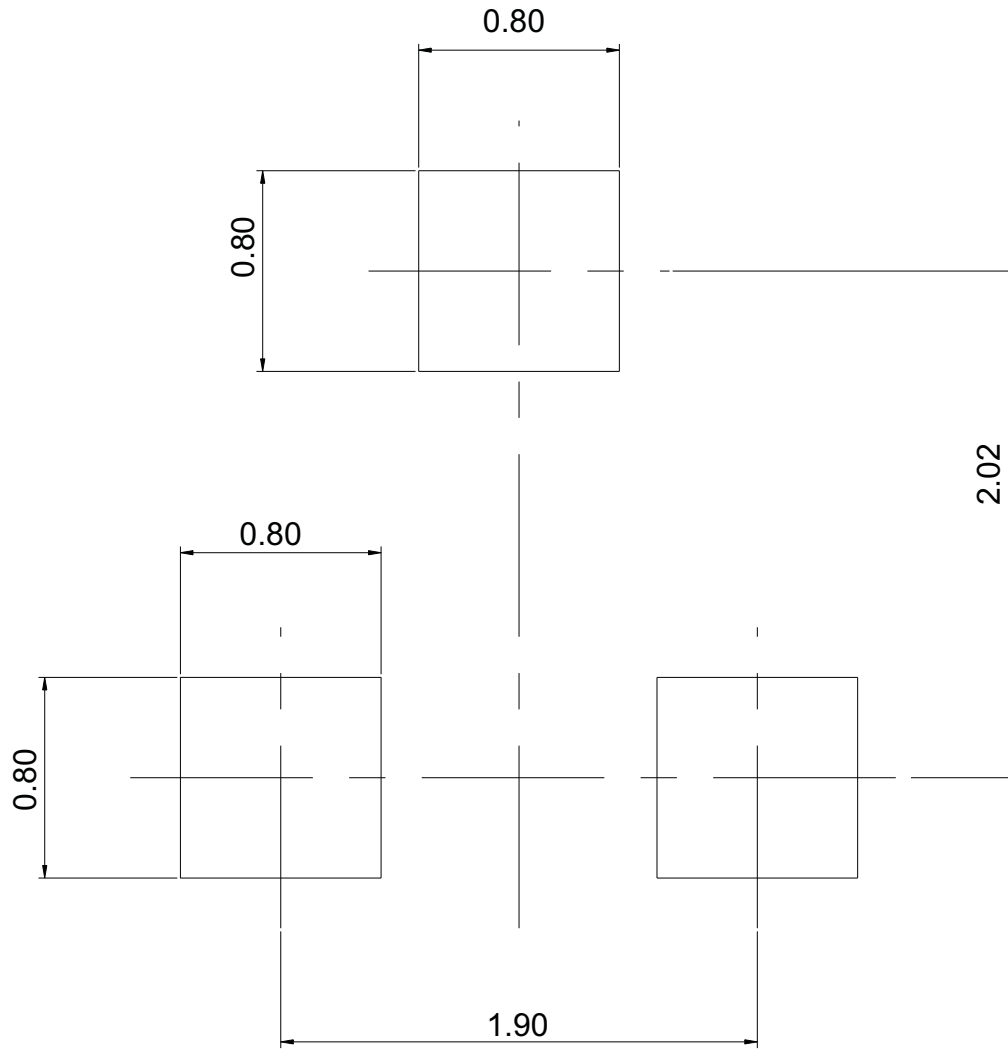

Center distance		1.90
Lead size	Lead width	0.40
	Lead length	0.55
Pad size	Pad width	0.80
	Pad length	0.80

Unit: mm

X-ON Electronics

Largest Supplier of Electrical and Electronic Components

Click to view similar products for [Bipolar Transistors - BJT category](#):

Click to view products by [GOODWORK manufacturer](#):

Other Similar products are found below :

[619691C](#) [MCH4017-TL-H](#) [MMBT-2369-TR](#) [BC546/116](#) [BC557/116](#) [BSW67A](#) [NJVMJD148T4G](#) [NTE123AP-10](#) [NTE153MCP](#) [NTE16](#)
[NTE195A](#) [NTE92](#) [2N4401-A](#) [2N6728](#) [2SA1419T-TD-H](#) [2SA2126-E](#) [2SB1204S-TL-E](#) [2SC2712S-GR,LF](#) [SP000011176](#) [2N2907A](#) [2N3904-](#)
[NS](#) [2N5769](#) [2SC2412KT146S](#) [CPH6501-TL-E](#) [MCH4021-TL-E](#) [MJE340](#) [Jantx2N5416](#) [US6T6TR](#) [NJL0281DG](#) [732314D](#) [CPH3121-TL-E](#)
[CPH6021-TL-H](#) [873787E](#) [IMZ2AT108](#) [MMST8098T146](#) [UMX21NTR](#) [MCH6102-TL-E](#) [NJL0302DG](#) [30A02MH-TL-E](#) [NTE13](#) [NTE26](#)
[NTE282](#) [NTE323](#) [NTE350](#) [NTE81](#) [STX83003-AP](#) [JANTX2N2920L](#) [JANSR2N2222AUB](#) [CMLT3946EG TR](#) [2SA1371D-AE](#)