

Gore Cable Assembly Builder

Microwave Assembly Part Number **0SR01R010480**

W. L. Gore & Associates has developed and proven a wide range of products specifically tailored to the RF / microwave industry. Since 1976, when Gore first introduced our microwave assemblies, Gore has remained a worldwide leader in providing custom microwave assemblies for demanding applications. Typical applications using GORE & Microwave Assemblies include: test, aerospace, defense, telecommunications and general purpose. With an unmatched history in demanding environments, you may be assured that Gore will provide the reliable products necessary to meet your individual system requirements.

GORE™ Mini-CP Cable is internally ruggedized with excellent phase and amplitude stability. With the ruggedization designed into the cable, the assemblies have excellent durability while remaining exceptionally lightweight and flexible. The exceptional performance of mini-cp cable enables accurate and repeatable measurements while limiting the need to perform time consuming calibrations between measurements.

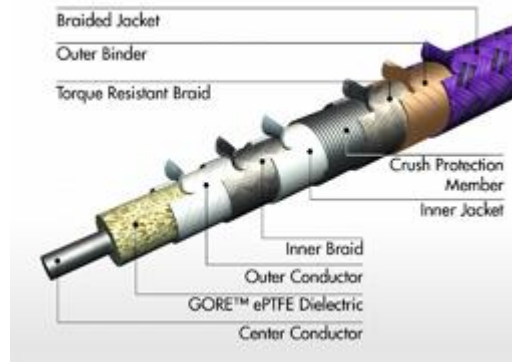

Key Features

- Phase and amplitude stability
- Crush, torque and kink resistant
- Phase matching options
- Replaceable interface options/adapters

Key Benefits

- Longer calibration intervals
- Longer field-service life
- Suited for parallel or comparative measurements
- Reduced risk of assembly damage

Specifications

Max Frequency GHz	18
Impedance Ohms	50
Center Conductor	Stranded
Dielectric Constant (nominal)	1.4
Velocity of Propagation	0.85
Temperature °C	-55 to 125
Nominal Outer Diameter in. (mm)	0.305 (7.7)
Minimum Bend Radius (multiple bends) in. (mm)	1 (25.4)
Nominal Weight g/ft (g/m)	45 (147.6)
Crush Resistance lb/linear in.	250
Typical Insertion Loss dB at 18GHz	-1.7540
Guaranteed Insertion Loss dB at 18GHz	-1.9479
Guaranteed VSWR at 18GHz	1.35:1
Guaranteed Return Loss dB	-16.53

Typical Insertion Loss

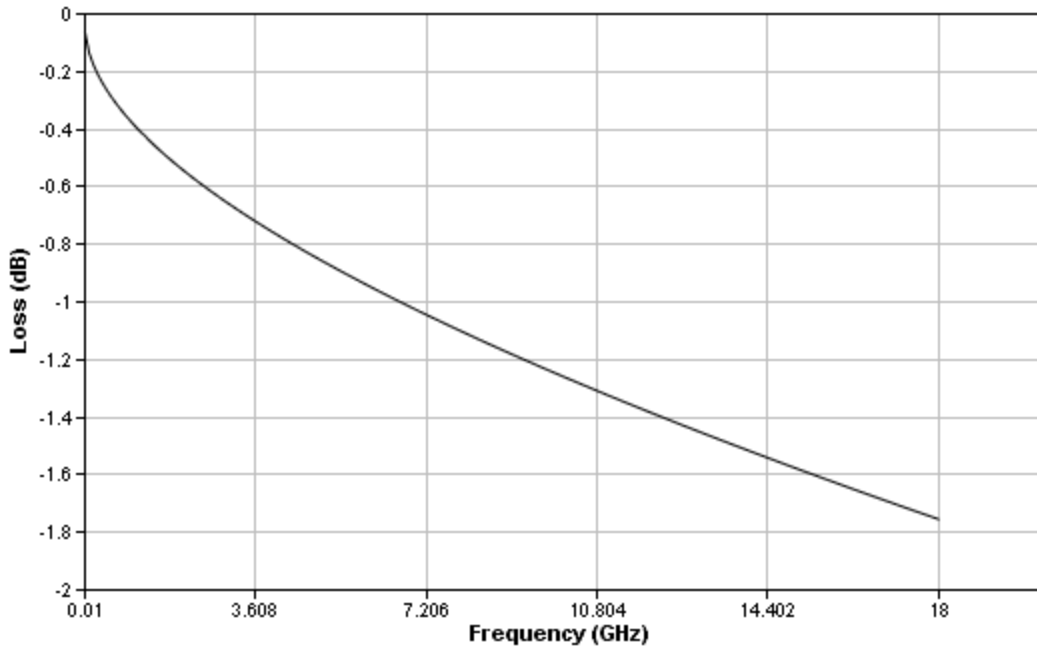

Guaranteed Insertion Loss

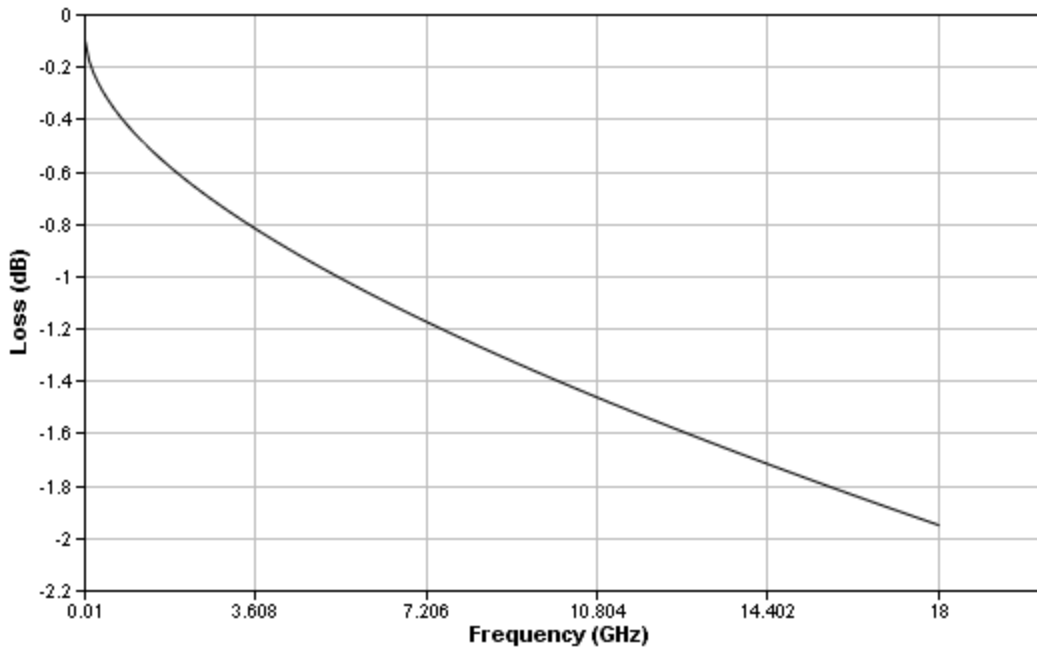

Connector A

Type: Straight, Family: SMA, Sex: Pin (Plug)

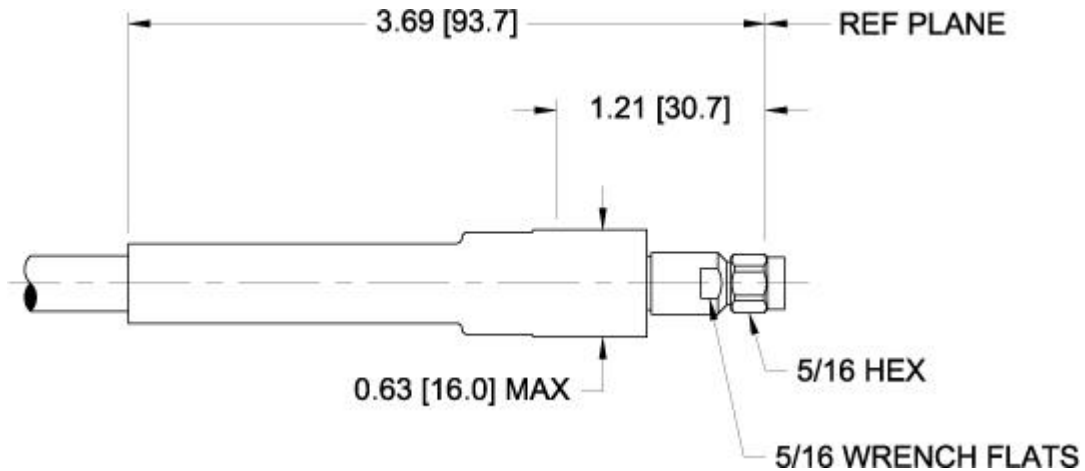
**Connector B**

Type: Straight, Family: SMA, Sex: Pin (Plug)

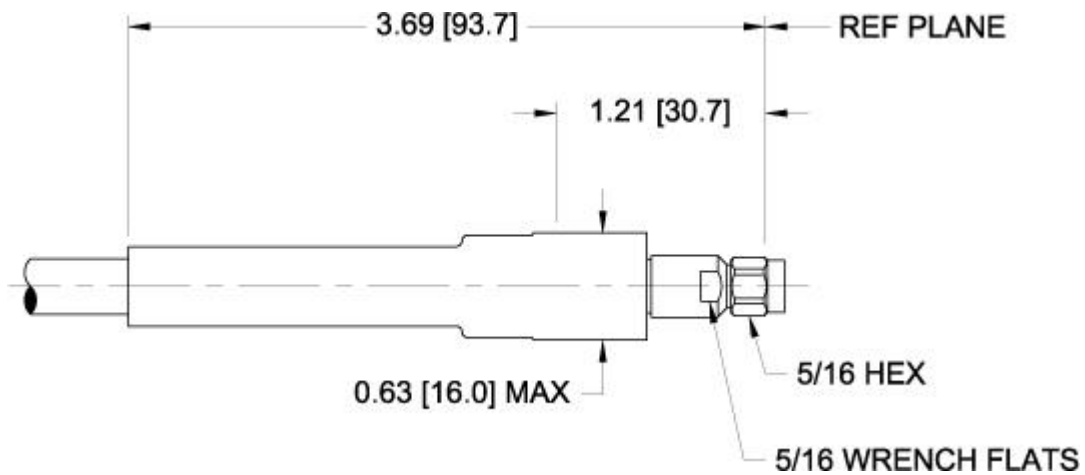

Phone (In USA) : 1-800-445-GORE (800-445-4673) Phone (outside the US) : +1/302-292-5100

The data in this datasheet applies to standard GORE & Microwave / RF Cable Assemblies and performance may vary based on specific application conditions.

X-ON Electronics

Largest Supplier of Electrical and Electronic Components

Click to view similar products for [RF Cable Assemblies](#) category:

Click to view products by [Gore](#) manufacturer:

Other Similar products are found below :

[73-6352-10](#) [73-6353-3](#) [73-6364-6](#) [R285001001](#) [R288940004](#) [145111-05-12.00](#) [1661-C-24](#) [1801171170914KE](#) [24P104C24J1-012](#)
[24P104C24P1-006](#) [24P104C24P1-018](#) [24P204C24J1-003](#) [172-2150-EX](#) [1800920920914PJ](#) [FCB-3030-ALT](#) [21117-046](#) [21117-050](#) [PCX-24-](#)
[50](#) [24P103C24P2-003](#) [25P203C25P2-003](#) [R284008001](#) [R285001021](#) [R285426000](#) [R288940003](#) [4814-BB-24](#) [5260-72](#) [JT2N1-CL1-1F](#) [DLP-](#)
[COAX1](#) [4814-K-48](#) [115101-09-06.00](#) [MXHT83QE3000](#) [CCNTN2-MM-LL335-26](#) [73-6351-25](#) [73-6352-3](#) [73-6353-25](#) [1800920920610PJ](#)
[GD0BQ0BQ024.0](#) [1-3636-600-5210](#) [TL8A-11SMA-11SMA-01500-51](#) [R284C0351060](#) [R288940009](#) [R284C0351028](#) [R288940002](#) [9702-](#)
[1SL-1](#) [PT82NSMA](#) [73-6353-10](#) [R285020301W](#) [PCX-18-50](#) [Minibend-9](#) [Minibend-4](#)