

MAVOWATT 230, 240, 270 & 270-400 Power Quality Analyzers

3-349-832-03
2/6.16

FEATURE SUMMARY

- Portable analyzer for power quality, demand & energy analysis
- 7-inch wide screen colour touch LCD for easy operation
- IEC 61000-4-30:2008, class A, EN 50160 provides legally recognized measurements
- 1000 V CAT III, 600 V CAT IV, provides for a variety of applications
- Frequency range 15-20 Hz and 45-65 Hz for flexible use
- Communication via Ethernet, WiFi, Bluetooth, USB for easy and safe data transfer
- Four current inputs (AC/DC) allow for the connection of flexible AC/DC current sensors
- Four symmetrical voltage channels (AC/DC, 50/60 Hz)
- Signal sampling with 512 samples per cycle
- Time synchronization via GPS and NTP
- Acquisition of sag/dip, swell, transients, unbalance, flicker
- Harmonics, interharmonics, mains signalling
- Automatic report generation
- Mini reports allow for convenient preparation of user-defined protocols
- Dashboard function to monitor individual real-time values
- Integrated 4 GB flash memory, USB port for external memory devices
- VNC remote control for PC, Mac, IOS & Android
- Convenient data analysis by means of the easy-to-use Dranview® 7 software
- Rugged protective housing (IP 50) with easel and cable management



SPECIAL FEATURES MAVOWATT 240 / 270 / 270-400



- Acquisition of transients in the micro second range (MAVOWATT 270, MAVOWATT 270-400)
- Intelligent Answer Modules ® allow for time-saving trouble shooting (MAVOWATT 240, MAVOWATT 270/-400)
- Inrush current, 10,000 recording cycles (MAVOWATT 240, MAVOWATT 270/-400)
- 400 Hz option for aviation, naval and military applications (MAVOWATT 270-400)

INTRODUCTION

The MAVOWATT 2XX series is a new generation of industry leading power quality, demand and energy analysis instruments from GOSSEN METRAWATT for measurements in the 1000 V CAT III, 600 V CAT IV application range.

The new MAVOWATT power quality analyzers merge tried-and-tested technology with high-precision measurements (IEC 61000-4-30: 2008, class A), innovative functions and

revolutionary communication options. Disturbances can thus be captured and located within the shortest period of time and recorded in compliance with standards.

Thanks to the huge 7-inch colour touch LCD, it provides convenient operation and immediate information on the power quality on site. Critical values are highlighted in red on the display for quick recognition and analysis. The versatile communication options, e.g. Ethernet, WiFi, Bluetooth, USB or Smartphone app offer a maximum of flexibility to the user.

MAVOWATT 230, 240, 270 & 270-400 Power Quality Analyzers

MAVOWATT 2XX APPLICATIONS

The portable analyzers are the right choice wherever power quality, demand and energy data must be captured precisely and conveniently. They have a 7-inch (18 cm) color, touch user interface that allows for easy setup and reporting using the local display. Ethernet, wireless and Bluetooth interfaces are available for the user to remotely control the instrument from a safe environment using a VNC interface Apple/Android Apps, greatly reducing exposure to hazardous environments. GOSSEN METRAWATT instruments measure 4 channels of Voltage and 4 channels of current to measure and detect changes in the electrical circuit being measured. The instrument measures Sags/Dips, Swells, Harmonics and Flicker in accordance with all accepted worldwide industry standards, such as IEC 61000-4-30:2008 Class A, IEC 61000-4-7, IEC 61000-4-15, IEEE 1159, IEEE 519 and IEEE 1453, and more. Low, medium and high frequency Transients are also measured (model dependant), as well as Power parameters, such as Watts, VA, VAR, Power Factor, Demand/Energy, and many more. The instruments are ideally suited for many industries and applications, such as:

- Electric Utilities
- Facilities
- Electrical contractors
- Hospital and Healthcare
- Military and Government
- Consultants
- Service
- Rental companies
- Education
- Chemical, petrochemical and other industries
- Many more

This data sheet describes the features, benefits, and specifications of the MAVOWATT 2XX instruments. Although many advanced features are shared by all MAVOWATT 2XX instruments, some features are only available in certain instruments, which are noted below.

MEASUREMENT INPUTS – ALL MAVOWATT 2XX

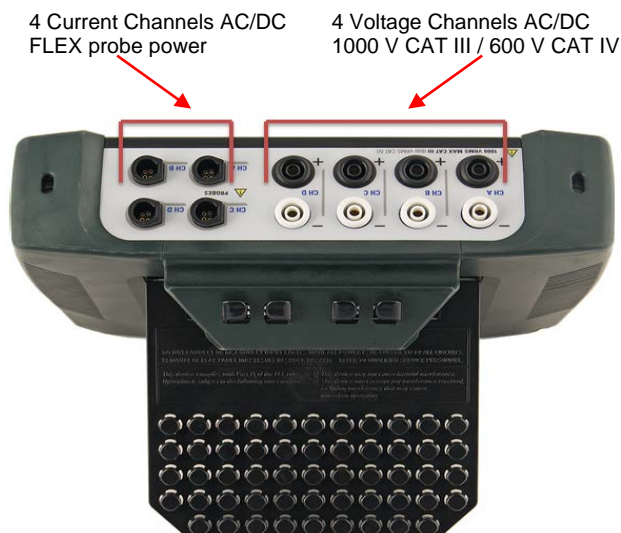

Voltage

All MAVOWATT 2XX have (4) differential AC/DC voltage channels rated 1000V CAT III/600V CAT IV. Voltage channels are labeled L1 (A), L2 (B), L3 (C) und L4 (D) and are connected to the circuit using supplied 1000V, 2 m black (+) and white (-) cables terminated in 4mm plugs and alligator clips. Colored cable clips are provided to match to identifying phase colors.

Current

All MAVOWATT 2XX instruments are equipped with four 1.5 V current measuring inputs (AC/DC) and current sensors of the „TR“, „PR“, „Dranflex“ and „Metraflex“ series by GOSSEN METRAWATT. Current channels are labeled L1 (A), L2 (B), L3 (C) und L4 (D) and are connected to the circuit using available GOSSEN METRAWATT clamp and Flex CT's. Each current connector supplies 3 V DC power to compatible GOSSEN METRAWATT Flex CT's.

COMMUNICATIONS – ALL MAVOWATT 2XX

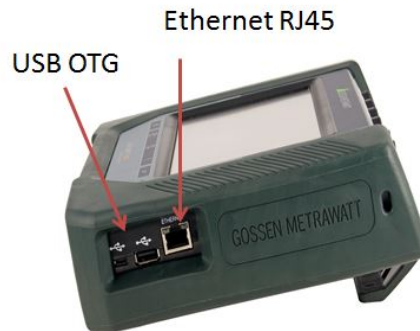

Ethernet – All MAVOWATT 2XX

RJ45 connector for 100BaseT Ethernet communications. Ethernet is used for remote control and data transfer using VNC communications.

USB– All MAVOWATT 2XX

Two USB (On The Go – OTG) ports are available including USB master (full size) and USB slave (micro). The full size USB connector is compatible with off-the-shelf external flash storage devices and the micro, slave connector, is for plug & play connections to a computer for data transfer.

Wireless – MAVOWATT 270, MAVOWATT 270-400, MAVOWATT 240

Built-in wireless adapter & antenna that supports 802.11a, b, and g wireless networks. Wireless is used for remote control and data transfer from MAVOWATT 2XX using VNC communications.

Bluetooth – Standard on MAVOWATT 270, MAVOWATT 270-400, MAVOWATT 240, optional on MAVOWATT 230

External Bluetooth USB adapter to establish a Personal Area Network (PAN) for remote control and data transfer from MAVOWATT 2XX using VNC communications. PC compatible only.

MAVOWATT 230, 240, 270 & 270-400 Power Quality Analyzers

INSTRUMENT POWER & GPS – ALL MAVOWATT 2XX

Instrument Power



External 90VAC-265VAC, 50/60HZ, 12V output universal power supply. US, UK, Euro, and Australian country plugs are included. A user accessible NIMH rechargeable battery (UPS) is included with a 2hr (3hr for MAVOWATT 230 & 240) run time on a full charge. Charge time for a depleted battery is 3hrs.

Time Synchronization

Three methods of time synchronization are available and the system will use the best available time source: GPS using an external GPS receiver for time synchronization to 1ms, Network Time Protocol (NTP) time synchronization via Ethernet or wireless for time synchronization to 10ms and internal clock.

CONTROLS – ALL MAVOWATT 2XX

Color LCD, Touch Display - All MAVOWATT 2XX



All MAVOWATT 2XX have a built-in 7-inch (measured diagonally) color LCD touch display with an LED backlight. The 7-inch LCD is the primary user interface for devices, including instrument setup, real-time metering, data analysis, and reporting.

Hard Buttons - All MAVOWATT 2XX



All MAVOWATT 2XX instruments have 3 'hard' buttons located beneath the LCD display. These buttons are for reporting and help functions that are available to the user at all times, regardless of the user interface screen being displayed.

The left and center buttons are for the Mini-Report feature. Mini-Reports are screen snapshots (pictures) of individual screens that are compiled into a single file. Mini-Reports are saved in an .xml format and can be viewed locally on the instrument's LCD or transferred to a computer for viewing in any compatible program, such as Microsoft Word.

The left (camera icon) button takes a snapshot of the screen presently displayed. The center (report icon) displays the Mini-Report viewer on the local LCD.

The right (? icon) displays context-sensitive help for the screen presently being displayed on the LCD.

PACKAGING – MAVOWATT 2XX INSTRUMENTS

Enclosure

All MAVOWATT 2XX instruments are packaged in an IP50, ergonomically designed ABS plastic enclosure with a protective rubber boot. The enclosure provides the user several unique, 'ease of use' features.

An integrated instrument hanger hook is mounted to the rear of the instrument. This hook allows for conveniently hanging the instrument on a breaker door, switchgear panel or other appropriate vertical surface. The hook also positions the instrument at a convenient viewing angle when used on a floor. The hook is easily removed and replaced by two hanging buttons for mounting the instruments in a weather resistant enclosure by GOSSEN METRAWATT, or other enclosure.

MAVOWATT 230, 240, 270 & 270-400 Power Quality Analyzers



REMOTE USER INTERFACES & CONTROLS – ALL MAVOWATT 2XX INSTRUMENTS

VNC (Virtual Network Computing)

All MAVOWATT 2XX instruments have a standard VNC remote control feature that allows the instruments to be fully controlled using virtually any PC, MAC, Apple, or Android tablet or Smartphone. VNC is a computing industry standard for secure, password protected remote control. Users download a free program or APP and connect remotely to MAVOWATT 2XX via an Ethernet, Wireless, or Bluetooth PAN network.

VNC uses instruments remote communication interfaces to allow the user to perform all instrument functions remotely, as if the user was touching (controlling) the 7-inch local user interface. Users have full remote control of monitoring setup, real-time meters, data analysis, and reporting.

By using VNC, MAVOWATT 2XX users can safely review data and control their instrument remotely while installed in switchgear or other hazardous locations.

Integrated cable management is available for the user to neatly and safely 'dress' the voltage and current measurement cables by securing them to the instrument. Wire retainers are available on the instrument hanger, as well as a unique cable guide system that is available on the instrument stand.



MAVOWATT 2XX instruments also have an integrated power cable retainer to secure the 12VDC power supply cable to the instrument, preventing it from being accidentally pulled out while monitoring.



MAVOWATT 230, 240, 270 & 270-400 Power Quality Analyzers

WIRING CONFIGURATIONS – ALL MAVOWATT 2XX

All MAVOWATT 2XX instruments can be connected to the following circuit types:

- Single phase
- Split Phase
- 3 Phase, Four Wire Wye
- 3 Phase Delta
- 3 Phase (Floating or Grounded) Delta
- 3 Phase 2-Watt Delta
- 2 1/2 Element without Voltage Channel L2 (B)
- 2 1/2 Element without Voltage Channel L3 (C)
- Generic Circuit – 4 single phase measurements
- Variations of the above

INSTRUMENT SETUP – ALL MAVOWATT 2XX

The new MAVOWATT- series offers both automatic and manual setup methods allowing users to be immediately productive, and to begin monitoring within minutes. Automatic setups are the quickest and easiest way to start monitoring in just a few steps. When connected to an energized circuit, the instrument automatically detects the circuit type, nominal voltage/current and displays them for review. The user can then set the current probe type and start monitoring immediately. The instrument will configure itself using triggers based upon the IEEE 1159 +/- 10% of nominal recommendations. Automatic setups are available for both Power Quality and Demand/Energy.

PQ MONITORING SETUP

Circuit Type: Split Phase
 Nominal Voltage: 120.00
 Nominal Current: 20.00
 Nominal Frequency: 60.00
 Free Space: 1.75 GB

	Volts	Amps
A	117.07	0.09
B	117.01	0.02
C	117.00	0.02
D	0.42	0.02

* Verify if the selected current probes are correct by pressing the Probe button.

The instrument is now ready for monitoring. trigger parameters and thresholds are set to monitor power quality. Please review the detected circuit for validity.

Wizard setups are also available for the user to have complete control over the instrument's setup and triggering. The Wizard setup guides you step-by-step through each setup category. Wizard setup categories are: Probes/Scaling, Wiring Configuration, Nominal/Frequency, Monitoring Mode, Trigger Limits, and Finalize. Each category is randomly accessible and guides the user through the settings available in each setup screen. The instrument will also inform the user of potential setup errors, such as mismatches between the circuit type setting and the circuit type automatically detected.

STEP-by-STEP MONITORING SETUP

	Volts	Amps
A	117.73	29.99
B	117.68	6.05
C	117.67	6.27
D	0.17	5.94

These next series of screens will guide you through the monitoring setup process. Whereas it is recommended that you go through each screen in sequence from left to right in order of the buttons at the top. You can skip ahead to any of the topics by selecting that icon button. However, this will leave the "skipped" items in their previously programmed setup, which may not be compatible with your present application.

POWER QUALITY MEASUREMENT FUNCTIONS – ALL MAVOWATT 2XX

The MAVOWATT 2XX instruments offer the latest in Power Quality, Demand and Energy measurement, and monitoring capabilities. Each model is Class A compliant with IEC61000-4-30:2008 and also supports EN50160:2009, IEEE 1159, IEEE 519, IEEE 1453 and IEEE 1459.

Data Acquisition

Each MAVOWATT 2XX instrument samples every cycle of each voltage and current channel 512 times. Sampling is gapless, which means each voltage and current cycle is continuously sampled without gaps between cycles. Sampling is controlled by a Phase Locked Loop (PLL) circuit that is referenced to channel L1 (A) by default, with other references available. The PLL automatically adjusts the sampling rate to the power line frequency to ensure the instrument always acquires 512 evenly spaced samples per cycle for every channel. Therefore, any variation in the power line frequency adjusts the sampling rate accordingly. This translates to a sampling rate of 30.72KHz at 60Hz and 25.6KHz at 50Hz. Switchable Anti-Aliasing filters are available for strict compliance with IEC61000-4-30 Class A. Note that switching in such filters may limit the transient response of the instrument. The instrument is Class A compliant with Anti-Aliasing filters switched either on or off.

The data acquired by the above process is digitized by a 16-bit Analog to Digital (A/D) converter and is used as the foundation for all voltage, current and power measurements, and computations that are available in the instrument. This technique of data acquisition is appropriate for low and medium frequency transients as defined by IEEE1159. At 512 samples per cycle, the time between samples is about 32µs at 60Hz and 39µs at 50Hz, which is adequate to record transient activity on most power systems. The MAVOWATT 270 and MAVOWATT 270 -400 have additional high speed transient circuitry for 1 microsecond transient detection.

MAVOWATT 230, 240, 270 & 270-400 Power Quality Analyzers

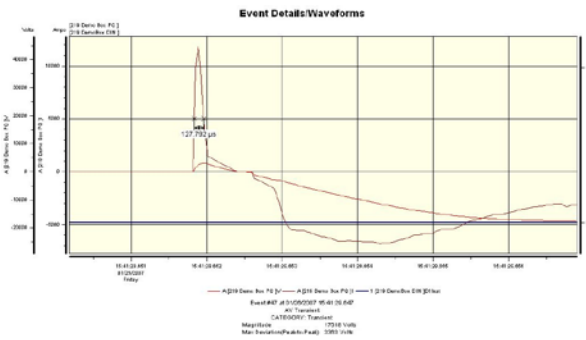

All MAVOWATT 2XX instruments have extensive transient capture capabilities. Each can capture low and medium frequency transients, with the MAVOWATT 270 and MAVOWATT 270-400 having additional circuitry to also capture high speed transients. It is important to note that the new MAVOWATT series goes well beyond the requirements of IEC61000-4-30 and EN50160. In addition, the new power analyzers employ the methods used for voltage transients to trigger on current transients.

Transient trigger methods available are:

- Instantaneous Peak – All MAVOWATT 2XX
- Cycle to Cycle Waveshape – All MAVOWATT 2XX
- RMS Difference Waveshape – All MAVOWATT 2XX
- High Speed Sampling – MAVOWATT 270, MAVOWATT 270-400

Power Quality Triggers

RMS Triggers

In accordance with IEC 61000-4-30 and other standards, RMS measurements are computed over one cycle, but incremented in $\frac{1}{2}$ cycle steps. IEC standards refer to this as $U_{rms}(1/2)$. It's important to note that the measurement window for PQ triggers is always 1 cycle, but the $\frac{1}{2}$ cycle increment allows for more detailed event detection. Any one cycle exceeding the instrument's limits will trigger an RMS type event, regardless if it's detected on a $\frac{1}{2}$ cycle boundary.

Instantaneous Peak

This trigger uses the RMS sampled data and looks for any one of the 512 samples to exceed the Instantaneous Peak limit. If at least one sample exceeds the limit, data is recorded to memory based upon the user's pre/post waveform settings. Applications for this trigger are events such as peak over voltage (or current), lightning strikes, etc...

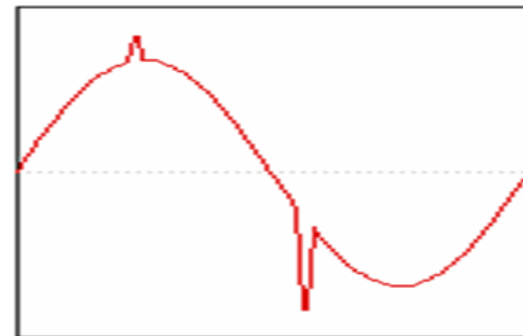
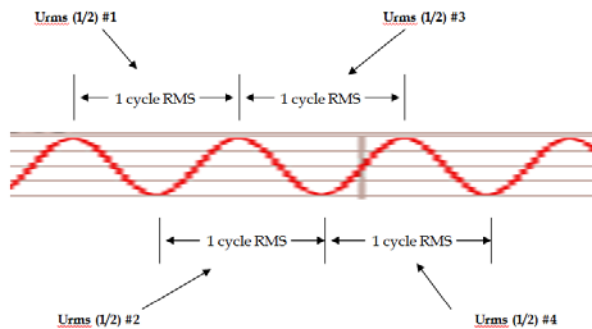

If a trigger occurs, data is stored to memory in accordance with the RMS Summary and Waveform (# of cycles recorded) settings entered during setup. Like other GOSSEN METRAWATT products, new MAVOWATT series detects and records current RMS events in the same manner as voltage. Please see the instrument user's guide for further details.

Waveshape Triggers

Waveshape triggers look for changes in each and every waveform on a cycle-by-cycle basis. These are important triggers, as many types of transients do not affect the waveshape enough to change the RMS or harmonics significantly. Therefore, traditional RMS triggers will not detect these events.

In addition to PQ triggers, the $U_{rms}(1/2)$ data is used as the basis for all voltage and current min, max and average measurements with a 1 cycle resolution with $\frac{1}{2}$ cycle steps.

There are two waveshape trigger methods available:

Transient Triggers

As per IEEE1159, transients are divided into three categories:

- Low frequency (<5Khz)
- Medium frequency (5 – 500Khz)
- High frequency (500Khz – 5Mhz)

- Cycle to cycle waveshape
- RMS distortion (or difference) waveshape

Both methods look for changes in the waveshape by comparing the present AC cycle to the previous AC cycle. If the difference exceeds the user's limits, an event is recorded. Both methods have been available in prior GOSSEN METRAWATT power analyzers. Even though these are similar trigger methods, both remain available since some users prefer one over the other. Both methods are available for voltage and current triggers.

MAVOWATT 230, 240, 270 & 270-400 Power Quality Analyzers

Cycle to Cycle Waveshape

This method breaks down the present AC waveform being measured into user defined windows of time (shown below in the circle) that represents a percentage of the overall waveform. Each window is compared to the same window of time in the previous waveform, and if the difference exceeds the user's limits, an event is recorded. In the picture below, the duration (width of the window) is 10% (1.67ms @60Hz), which means the waveform is broken down into 10 consecutive windows, with each representing 10% of the overall waveform. If the duration were 50%, the waveform would be broken down into 2 windows, with each representing 50% (8.3ms) of the overall waveform.

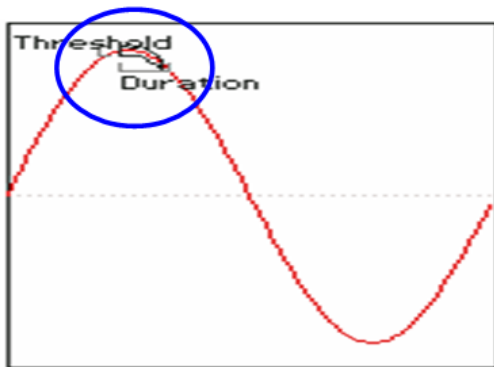

RMS distortion (or difference) waveshape

This method performs a (sample) point-by-point subtraction of the previous waveform from the present waveform. If the waveforms are the same, the difference will be zero; otherwise the difference will be the change in waveshape from the previous to present waveform. If the difference exceeds the customer's limits, an event is recorded.

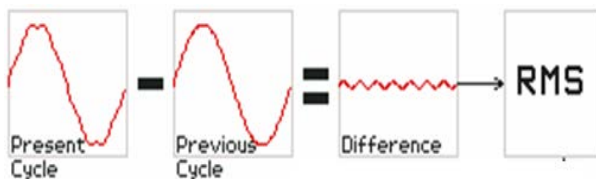

High Speed Sampling – MAVOWATT 270, MAVOWATT 270-400

High frequency detected transients use special circuitry to detect and capture transients as small as 1 microsecond in duration. These transients can be positive and/or negative values above or below the low frequency waveshape.

Magnitude of Supply 200ms Window

IEC 61000-4-30 and IEC61000-4-7 require data be acquired over a 200ms window for use in certain measurements, such as magnitude of supply, harmonics, and interharmonics. The 200ms window equates to 12 cycles at 60Hz and 10 cycles at 50Hz. A 10 cycle 50Hz example is shown below. In addition, Class A compliance requires the 200ms windows to be

gapless, meaning that any processing by the instrument must be completed in time to process the next 200ms window without any gaps between windows. Being Class A, the MAVOWATT 2XX instruments fully complies with these requirements.

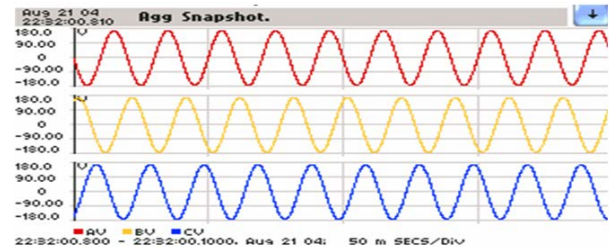

Harmonics & Interharmonics

Harmonic & Interharmonic computations are in accordance with IEC61000-4-7 and IEEE 519, which dictate that harmonic analysis is done using a synchronous 200ms window of 10 cycles for 50Hz, or 12 cycles for 60Hz. Successive 200ms windows are gapless. This results in frequency bins that are nominally 5Hz wide. The actual width of the bin is equal to the actual frequency divided by 10 if the nominal frequency is 50Hz, and 12 if 60Hz. For example, if the actual frequency is 49.9 Hz, the bin is 4.99Hz, but is labeled "5Hz".

All harmonic based triggering of the MAVOWATT 2XX series is based upon the (DFT) harmonic analysis and computations of each 200ms magnitude of supply window. Results are used for all harmonic parameters, computations and triggers. Therefore, 200ms is the smallest unit of measurement for harmonic type parameters and is the basis for all associated min, max, and average measurements.

Harmonic parameters include:

VTHD, ITHD, VTID, ITID, K-Factor, TIF, TDF, User Specified (individual) Harmonics, Mains Signalling Frequencies, and other parameters.

Please see the parameter list below for a complete list of parameters.

Voltage Flicker

Voltage Flicker computations are in full compliance with IEC 61000-4-15 and IEEE 1453. Flicker is a phenomenon due primarily to small, rapid fluctuations of the voltage. Loads that exhibit continuous, rapid variations in the load current, particularly the reactive component, can cause voltage variations, often referred to as flicker. Flicker is characterized by modulation at a frequency that is typically less than 25Hz. Modulating signal magnitudes as low as 0.5% of the fundamental for frequencies between 5-10Hz can result in perceptible light flicker.

Voltage Flicker parameters include: PST, PLT, PLT (slide), and Pinst.

MAVOWATT 230, 240, 270 & 270-400 Power Quality Analyzers

Unbalance/Imbalance

Unbalance is the relationship between the magnitude and phase angle of power system phases. A three phase power system is considered balanced when the magnitude of the voltage and current in each phase is equal, and each phase is separated equally by 120 degrees. Any change from this ideal indicates an Unbalance (Imbalance). Depending on your geographic region, different references may be used, so the MAVOWATT 2XX support several methods of computing unbalance:

V/I Sequence

Positive, Negative, and Zero sequence components for both Voltage and Current.

V/I Unbalance

Voltage Unbalance (RMS/RMSAverage),
Voltage Unbalance (S2/S1),
Voltage Unbalance (S0/S1),
Current Unbalance (RMS/RMS Average),
Current Unbalance (S2/S1),
Current Unbalance (S0/S1),
Voltage Imbalance, and
Current Imbalance.

REPORTING AND COMPLIANCE – ALL MAVOWATT 2XX

The MAVOWATT 2XX instruments have many reporting functions available, and the user can choose the reporting method that best suits the needs of the application. Basic reporting (such as real-time meters), historical trends and event lists show data in its basic form. More advanced reporting, such as EN50160 compliance, Dashboard alarm panels, and a Mini-Report are also available. Like all GOSSEN METRAWATT portable power analyzers, the new series of MAVOWATT is fully compatible with Dran-View® 7 Power Quality, Demand and Energy analysis, and reporting software.

Real-time Meters, Trends and Event Lists

All parameters available in the new instruments can be metered in real-time, trended over time, and can have trigger conditions enabled to record details of changes in each parameter. The resolution of each trigger is parameter dependent.

Real-time meters display the instantaneous value of each parameter, which is updated about every second.

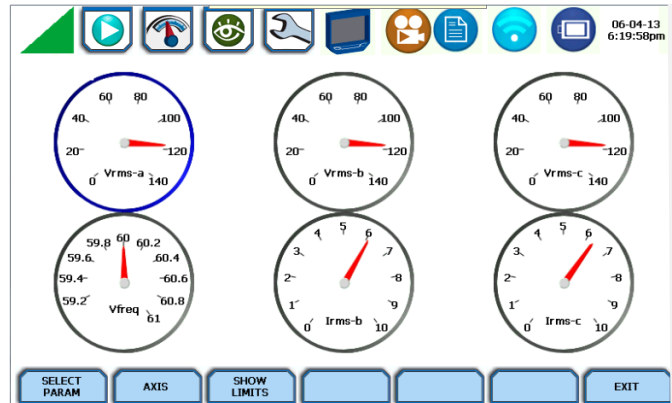

For monitoring, users can set Journal intervals that record data at pre-determined timed intervals, regardless of whether or not trigger conditions have been met. Four independent Journal time categories are available: Power (V, I, W, etc.), Demand/Energy, Harmonics, and Flicker. Depending on the parameter, the Journal interval timer can range from seconds to minutes to hours. Once Journal intervals are recorded, the user can trend the minimum, maximum, and average of most enabled parameters. Trend graphs can be configured in a stacked or overlaid display mode and are zoomable to magnify any data of interest.

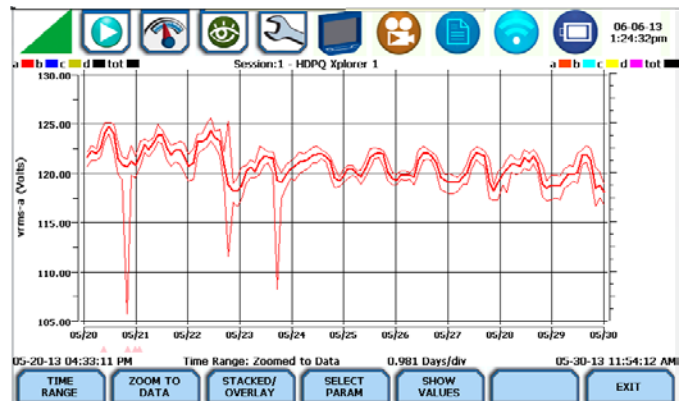

Event lists are available to indicate any triggered events recorded to the instrument's database. The event list appears in chronological order and the user can scroll the list and select any event for further analysis. Both time and type filters are available for the user to select a specific time period to display and the type of event, such as RMS or Transient.

Date	Time	Phase	Event Type	Parameters
2013-05-23	22:55:28.55	BV	Transient	0.567 msec, pk-pk: 0.0
2013-05-23	22:55:28.55	AV	Transient	8.567 msec, pk-pk: 0.0
2013-05-23	22:55:28.50	AV	Sag	0.050 secs, min: 81.0 max: 94.7
2013-05-23	22:55:28.50	BV	Sag	0.058 secs, min: 81.0 max: 94.7
2013-05-23	22:55:28.50	CV	Sag	0.050 secs, min: 81.0 max: 94.7
2013-05-23	22:55:28.48	CV	Transient	8.330 msec, pk-pk: 0.0
2013-05-23	22:55:28.48	BV	Transient	0.330 msec, pk-pk: 0.0
2013-05-23	22:55:28.48	AV	Transient	8.330 msec, pk-pk: 0.0
2013-05-23	09:19:22.11	AV	Swell	0.225 secs, min: 131.3 max: 138.7
2013-05-23	09:19:22.11	BV	Swell	0.225 secs, min: 131.2 max: 138.6
2013-05-23	09:19:22.11	CV	Swell	0.225 secs, min: 131.3 max: 138.7
2013-05-23	00:41:43.65	AV	Swell	0.250 secs, min: 132.3 max: 139.2

MAVOWATT 230, 240, 270 & 270-400 Power Quality Analyzers

Compliance - EN50160:2010

EN50160 is a European standard for the statistical analysis of power quality data. The statistical package called Quality of Supply (QOS) is built into the new MAVOWATT series, with monitoring and setup protocols available to determine compliance with the EN 50160:2010 standard. The EN 50160-required measurement parameters include Power Frequency, Supply Voltage Variations, Rapid Voltage Changes, Supply Voltage Unbalance, Harmonic Voltage, Interharmonic Voltage, and Mains Signalling. The monitoring site is said to be IN COMPLIANCE if the statistical value over one week for the specified parameters is 95% or greater. The EN50160 options setup allows users to define up to five mains signalling frequencies below 3KHz. Users can also select pre-defined values for main voltage characteristics of the electricity supplied.

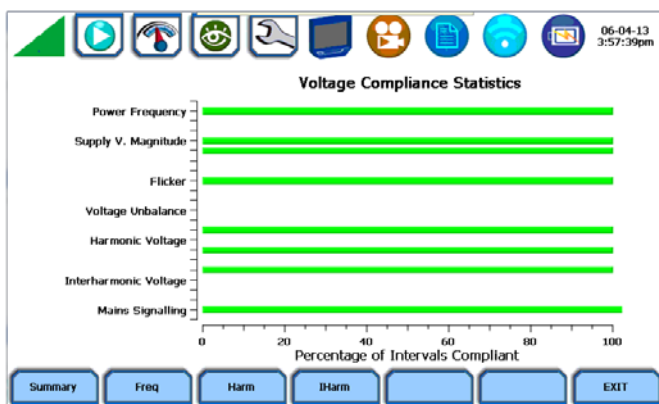

Reporting

Any instrument can provide trends and event lists detailing what's been recorded during a power survey, but users want results quickly. The reporting functions make analysis quick and easy by summarizing survey data and results in easy-to-use formats. When combined with the advanced remote control capabilities of MAVOWATT 2XX, users can easily see their results from anywhere with connectivity to the instrument.

Mini-Reports

The Mini-Report is a fast and easy way to generate custom reports directly from the instrument's front panel. Mini-Reports are a compilation of user snapshots of any screen shown on the local MAVOWATT 2XX display. By simply pressing the Snapshot (camera) button on the front panel, a .bmp file containing a picture of the screen presently displayed is added to the Mini-Report. The Mini-Report is stored as in an .xml format and can be uploaded to any computer, Tablet, or Smartphone for viewing in a web browser. Once uploaded, users can annotate the Mini-Report and add comments or make any changes using Microsoft Word or any other .html editor. Users can keep the file in a .xml format or "Save As" and convert to .doc, .rtf, or other formats. Also, each screen image displayed in the Mini-Report is a separate .bmp file, so it can be treated individually for emailing, incorporating in other documents, or any other use.

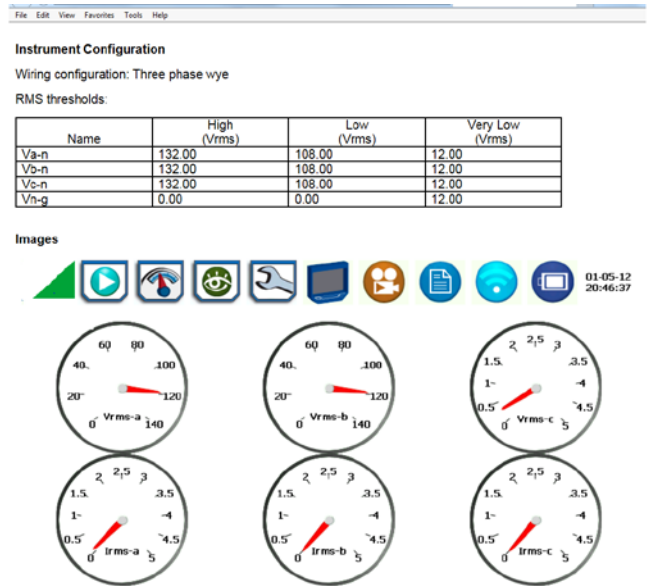

Dashboard Alarm Panel

The Dashboard alarm panel is a combination of real-time measurements and triggered data on one screen, summarizing your monitoring survey in one easy-to-use reporting screen. The Dashboard is an alarm panel with cells that represent real-time meters and recording status of parameters being measured. Cells are color-coded so the user can easily understand if events have been recorded for the parameters displayed. For Power Quality, Voltage and Current squares are green or red indicating if HI or LOW trigger conditions have been met. Green squares indicate no alarms or events have been recorded for that parameter. A red cell indicates an alarm condition and that an event has been recorded for that parameter. By pressing the cell, the user can view details of the event(s). For Harmonics, Flicker, Power, Demand, Energy, and other parameters, HI/LO and VERY HI/VERY LO triggers are available to indicate both warning and severe conditions. For such parameters, HI/LO alarms are indicated by a yellow color and VERY HI/VERY LO alarms are indicated by a red color. Once the user has reviewed the Dashboard, the alarms can be cleared and all red and yellow squares will return to a green color until the next alarm condition occurs. A grey color indicates monitoring for that parameter is disabled.

MAVOWATT 230, 240, 270 & 270-400 Power Quality Analyzers

RMS Voltage	RMS Current	Frequency	Transformer Derating
A 117.94 B 119.80 C 119.96	A 435.37 B 483.36 C 475.53	Line 59.96	A 978m B 984m C 978m
Pst	Sag	Swell	Transient
A 250m B 240m C 250m	Count 0	Count 0	Count 0
Active Power	Voltage THD	V Unbalance (S2/S1)	I Unbalance (S2/S1)
A 48.436k B 54.451k C 53.641k	A 2.98 B 2.81 C 3.02	A 1.09 B 474m C 611m	A 6.32 B 4.00 C 2.32

POWER, DEMAND & ENERGY MEASUREMENT FUNCTIONS - ALL MAVOWATT 2XX

In addition to Power Quality, the new instruments also have extensive Power, Demand & Energy metering, survey and reporting functions. The user can easily conduct a Power Quality survey, Demand and Energy survey, or both simultaneously. The user has complete control of parameters enabled without limit.

Like the Power Quality parameters, the MAVOWATT 2XX provide real-time meters, historical trends and condition based triggers for power flow parameters. Such parameters are treated the same and are viewed using the same reporting methods. The only difference may be the resolution of the data being displayed, since it is not recorded on a cycle-by-cycle basis as with the Power Quality parameters.

Energy	Demand - Total	Predicted - Total	RMS Voltage
A 133.73 B 1.23 C 743m	Watt 896.58 VAr 1.0715k VA 2.1056k	Watt 902.38 VAr 1.0783k VA 2.1166k	A 117.35 B 117.28 C 117.27
RMS Current	W	VA	VAR
A 11.96 B 6.05 C 6.27	A 892.12 B 7.93 C 4.93	A 1.4037k B 709.39 C 734.96	A 1.0825k B -6.72 C -6.91
PF	Daily Pk Dmd	Weekly Pk Dmd	Monthly Pk Dmd
A 636m B -11.2m C -6.71m	Tot 896.58	Tot 896.58	Tot 896.58

	Active Power	Apparent Pwr	Reactive Pwr	True PF	Displace PF
A	46.867k	48.969k	13.457k	956m	961m
B	48.269k	51.245k	16.630k	941m	945m
C	50.904k	54.585k	19.223k	931m	936m
D	-23.7µ	4.33m	5.56µ	-214m	-974m
TOTAL	146.04k	154.80k	49.310k	942m	945m

Dashboards available are: Power Quality, Energy/Demand and Motor Health.

Dran-View® 7

Dran-View® 7 is a Windows-based software package that enables power professionals to simply and quickly visualize and analyze power monitoring data. It is easy to navigate, delivers automated functionality, and incorporates powerful analytical capabilities and customizable options to meet the needs of each individual user. By supporting more than 12 languages, Dran-View is used by thousands of customers around the world and has become the industry leading power management software tool. Dran-View is available in two versions, Pro and Enterprise, so there's a version to meet everyone's needs.

Like all GOSSEN METRAWATT portable power analyzers, new series is directly compatible with Dran-View. Please see the supporting documentation for Dran-View for more information.

Power type parameters available in the MAVOWATT 2XX are: Watts, VA, VAR, Power Factor, Displacement Power Factor, Demand (Active, VA, VAR), Energy (WHR, VAHr, VARHr). The MAVOWATT 270 and MAVOWATT 270-400 add Forward and Reverse energy parameters.

Please see the parameter list starting on page 12 for a complete list of parameters.

MAVOWATT 230, 240, 270 & 270-400 Power Quality Analyzers

MAVOWATT 230/240/270/270-400 DIMENSIONS

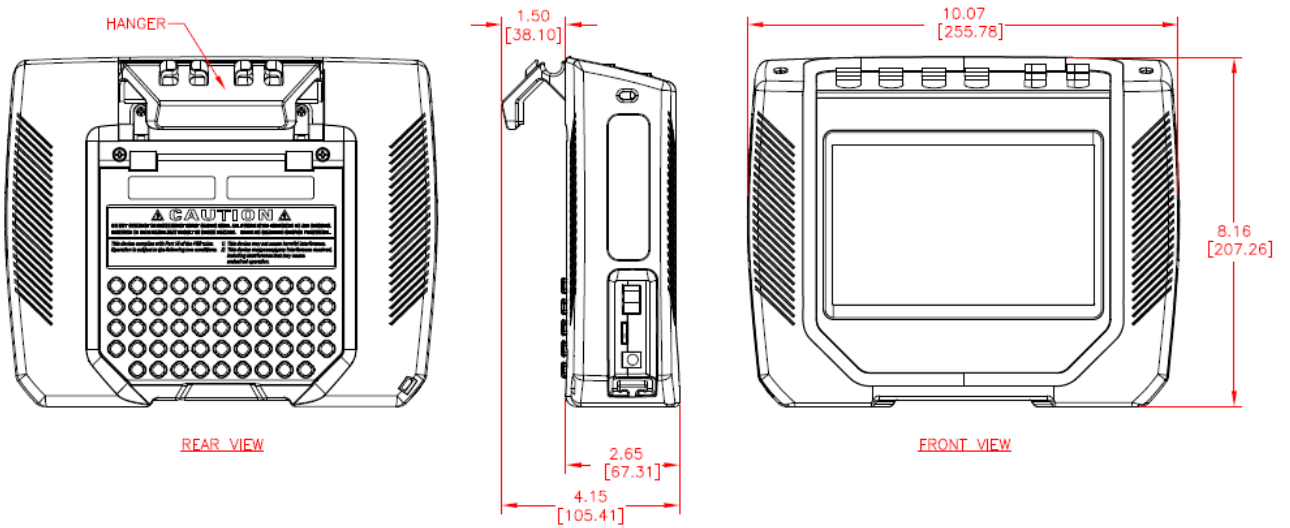

SHOWN WITH HANGER INSTALLED

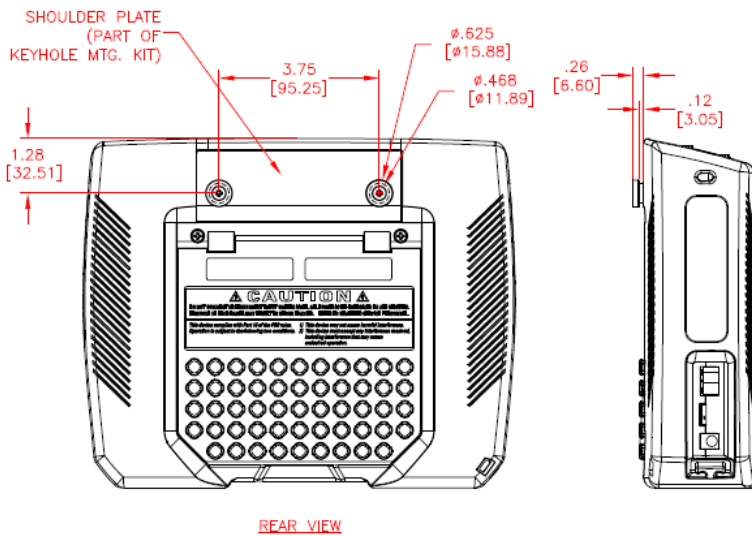

SHOWN WITH KEYHOLE MOUNTING KIT INSTALLED

MAVOWATT OUTLINE DIMENSIONS
FOR REFERENCE ONLY
SUBJECT TO CHANGE WITHOUT NOTICE
NOT RESPONSIBLE FOR TYPOGRAPHICAL ERRORS
DIMENSIONS ARE IN INCHES [MM]

MAVOWATT 230, 240, 270 & 270-400 Power Quality Analyzers

PQ Parameter Calculations

Calculations

Measuring and monitoring power quality (PQ) parameters require several calculations, i.e. RMS values of voltage and current, etc. Depending on the type of parameter measured, calculations are performed using samples of monitored waveforms or using every sample cycle for quick disturbance detection. This section defines the parameters used in PQ calculations.

NOTE: The parameter specifications provided in this section are for reference only and are subject to change without notice.

Description	Abbreviation	Wiring Configuration	Formula	Units	Precision
Volts RMS Derived from 200 mS (10/12 cycles 50/60 Hz) Aggregated to selected interval	Vrms-a Vrms-b Vrms-c Vrms-d	Single phase Split phase Wye	$V_{rms} = \sqrt{\frac{\sum_{i=1}^n U^2}{n}}$ where n=512 samples	Volts	+/- 0.1% of Reading * 15 KHz BW
	Vrms-ab rms-bc Vrms-ca	Measured for Delta Calculated for Wye			
Volts DC Derived from 200mS (10/12 cycles 50/60 Hz) Aggregated to selected interval	Vdc-a Vdc-b Vdc-c Vdc-d	Single phase Split phase Wye	$V_{dc} = \frac{\sum_{i=1}^n U}{n}$ where n=512 samples	Volts	+/- 0.2% of Reading *
	Vdc-ab Vdc-bc Vdc-ca	Measured for Delta Calculated for Wye			
Volts ½ cycle slide Cyclic RMS of full cycle restarted every ½ cycle (used in Sag/Swell detection)	Vcyc-a Vcyc-b Vcyc-c Vcyc-d	Single phase Split phase Wye	$V_{rms} = \sqrt{\frac{\sum_{i=1}^n U^2}{n}}$ where n=512 samples	Volts	+/- 0.2% of Reading *
	Vcyc-ab Vcyc-bc Vcyc-ca	Measured for Delta Calculated for Wye			
DC of individual Cycle	Vcycdc-a Vcycdc-b Vcycdc-c Vcycdc-d	Single phase Split phase Wye	$V_{dc} = \frac{\sum_{i=1}^n U}{n}$ where n=512 samples	Volts	+/- 0.2% of Reading *
	Vcycdc-ab Vcycdc-bc Vcycdc-ca	Measured for Delta Calculated for Wye			

* +/- 0.05 % of FS for input < 40 V

MAVOWATT 230, 240, 270 & 270-400 Power Quality Analyzers

Description	Abbreviation	Wiring Configuration	Formula	Units	Precision
<p>RMS Deviation</p> <p>Subtraction of 1 cycle RMS from adjacent cycles. Used for cyclic waveshape transient trigger system.</p>	Vcycw-a Vcycw-b Vcycw-c Vcycw-d	Single phase Split phase Wye	Vrms(cycle 1) - Vrms(cycle 2)	Volts	+/- 0.2% of Reading * 15 KHz BW
	Vcycw-ab Vcycw-bc Vcycw-ca	Measured for Delta Not Calculated for Wye			
<p>Maximum magnitude value of Crest.</p> <p>Largest Absolute magnitude of samples in a ½ cycle. Used for cyclic waveshape transient trigger system.</p>	Vpk-a Vpk-b Vpk-c Vpk-d	Single phase Split phase Wye	Largest Absolute magnitude of 256 samples (1/2 cycle)	Volts	+/- 0.2% of Reading *
	Vpk-ab Vpk-bc Vpk-ca	Measured for Delta Not Calculated for Wye			
<p>Phase of fundamental on individual cycle.</p> <p>Derived from DFT output based on sync channel.</p>	Vcycdeg-a Vcycdeg-b Vcycdeg-c Vcycdeg-d	Single phase Split phase Wye	$f(t) = \sin \omega_n \tau + \delta_n$ where g= phase where n=1 for 1 st harmonic	Degree	+/- 1°
	Vcycdeg-ab Vcycdeg-bc Vcycdeg-ca	Measured for Delta Calculated for Wye			
<p>Phase of fundamental averaged over 200ms.</p> <p>Derived from DFT sine expansion output.</p>	Vdeg-a Vdeg-b Vdeg-c Vdeg-d	Single phase Split phase Wye	$f(t) = \sin \omega_n \tau + \delta_n$ where n=1 for 1 st harmonic Averaged over 10/12 cycles	Degree	+/- 1°
	Vdeg-ab Vdeg-bc Vdeg-ca	Measured for Delta Calculated for Wye			
* +/- 0.05 % of FS for input < 40 V					

MAVOWATT 230, 240, 270 & 270-400 Power Quality Analyzers

Description	Abbreviation	Wiring Configuration	Formula	Units	Precision
Volts RMS of fundamental Derived from DFT	Vfnd-a Vfnd-b Vfnd-c Vfnd-d	Single phase Split phase Wye	$V_{fund} = \frac{V_{pk}}{\sqrt{2}}$	Volts	+/- 0.2% of Reading * 15 KHz BW
	Vfnd-ab Vfnd-bc Vfnd-ca	Measured for Delta Calculated for Wye	V_{pk} is calculated from the 1 st harmonic of DFT		
NEMA Unbalance Max deviation of the 3 phases from the average of the 3.	Vunbal-a Vunbal-b Vunbal-c	Measured for Wye	$V_{unbal} = \frac{ V_x - V_{avg} }{V_{avg}}$	%	+/- 1 %
	Vunbal-max		V_x is channel with largest deviation from average		
	Vunbal-ab Vunbal-bc Vunbal-ca	Measured for Delta Not Calculated for Wye	V_{avg} is average of the three channels		
Symmetrical Components					
Zero Sequence	Vseqzro	Delta or Wye only	$U0_a = \frac{1}{3} [U_a + U_b + U_c]$	None	+/- 0.15 %
Positive Sequence	Vseqpos		$U1_a = \frac{1}{3} [U_a + a^1 U_b + 2a^2 U_c]$		
Negative Sequence	Vseqneg		$U2_a = \frac{1}{3} [U_a + 2a^1 U_b + a^2 U_c]$		
Negative Unbalance	Vunbalneg		$\frac{S_2}{S_1} \text{ or } \frac{U2_a}{U1_a}$		
Zero Unbalance	Vunbalzro		$\frac{S_0}{S_1} \text{ or } \frac{U0_a}{U1_a}$		
Frequency Freq of sync channel	Vfreq	Any	$\left[\frac{\text{Sum of 10s of cycles periods}}{10} \right]^{-1}$	Hz	+/- 10 mHz
Rapid Voltage Change	Vrvc-a	Any	Max Deviation from 1 sec steady state RMS as defined in NVE-1157	%	+/- 0.2 %
	Vrvc-b				
	Vrvc-c				
	Vrvc-d				
* +/- 0.05 % of FS for input < 40 V					

MAVOWATT 230, 240, 270 & 270-400 Power Quality Analyzers

Description	Abbreviation	Wiring Configuration	Formula	Units	Precision
Amps RMS Derived from 200mS (10/12 cycles 50/60 Hz) Aggregated to selected interval	lrms-a lrms-b lrms-c lrms-d	Any	$I_{rms} = \sqrt{\frac{\sum_{i=1}^n I^2}{n}}$ where n=512 samples	Amps	+/- 0.1 % of Reading +/- 0.05 % of FS 9 KHz BW
Amp ½ cycle slide Cyclic RMS of full cycle restarted every ½ cycle	lcyc-a lcyc-b lcyc-c lcyc-d	Any	$I_{rms} = \sqrt{\frac{\sum_{i=1}^n I^2}{n}}$ where n=512 samples	Amps	+/- 0.1 % of Reading +/- 0.1 % of FS 9 KHz BW
Amps DC Derived from 200mS (10/12 cycles 50/60 Hz) Aggregated to selected interval.	ldc-a ldc-b ldc-c ldc-d	Any	$I_{dc} = \frac{\sum_{i=1}^n I}{n}$ where n=512 samples	Amps	+/- 0.2 % of Reading +/- 0.1 % of FS
RMS Deviation Subtraction of 1 cycle RMS from adjacent cycles. Used for cyclic waveshape transient trigger system.	lcycw-a lcycw-b lcycw-c lcycw-d	Single phase Split phase Wye	$I_{rms}(\text{cycle 1}) - I_{rms}(\text{cycle 2})$	Amps	+/- 0.2 % of Reading +/- 0.1 % of FS 9 KHz BW
Maximum magnitude value of Crest. Largest Absolute magnitude of samples in a ½ cycle. Used for cyclic waveshape transient trigger system.	lpk-a lpk-b lpk-c lpk-d	Single phase Split phase Wye	Largest Absolute magnitude of 256 samples (1/2 cycle)	Amps	+/- 0.2 % of Reading +/- 0.1 % of FS
DC of individual Cycle	lcydc-a lcydc-b lcydc-c lcydc-d	Any	$I_{dc} = \frac{\sum_{i=1}^n I}{n}$ where n=512 samples	Amps	+/- 0.2 % of Reading

MAVOWATT 230, 240, 270 & 270-400 Power Quality Analyzers

Description	Abbreviation	Wiring Configuration	Formula	Units	Precision
Phase of fundamental averaged over 200 ms. Derived from DFT sine expansion output.	ldeg-a ldeg-b ldeg-c ldeg-d	Any	$f(t) = \sin \omega_n \tau + \delta_n$ where n=1 for 1 st harmonic. Averaged over 10/12 cycles	Degree	+/- 1°
Phase of fundamental on individual cycle. Derived from DFT output based on sync channel.	lcydeg-a lcydeg-b lcydeg-c lcydeg-d	Any	$f(t) = \sin \omega_n \tau + \delta_n$ where g= phase where n=1 for 1 st harmonic	Degree	+/- 1°
Amps RMS of fundamental Derived from DFT	lfnd-a lfnd-b lfnd-c lfnd-d	Any	$I_{fund} = \frac{I_{pk}}{\sqrt{2}}$ I_{pk} is calculated from the 1 st harmonic of DFT	Volts	+/- 0.2 % of Reading 9 KHz BW
NEMA Current Unbalance Max deviation of the 3 phases from the average of the 3.	lunbal-a lunbal-b lunbal-c	Any	$I_{unbal} = \frac{ I_x - I_{avg} }{I_{avg}}$	%	+/- 1 %
Symmetrical Components					
Zero Sequence	lseqzro	Delta or Wye only	$U_{0a} = \frac{1}{3} [U_a + U_b + U_c]$	None	+/- 1 %
Positive Sequence	lseqpos		$U_{1a} = \frac{1}{3} [U_a + a^1 U_b + 2a^2 U_c]$		
Negative Sequence	lseqneg		$U_{2a} = \frac{1}{3} [U_a + 2a^1 U_b + a^2 U_c]$		
Negative Unbalance	lunbalneg		$\frac{S_2}{S_1} \frac{U_{2a}}{U_{1a}}$		
Zero Unbalance	lunbalzro		$\frac{S_0}{S_1} \frac{U_{0a}}{U_{1a}}$		

MAVOWATT 230, 240, 270 & 270-400 Power Quality Analyzers

Description	Abbreviation	Wiring Configuration	Formula	Units	Precision
Residual Current	Ires	Delta or Wye only	RMS of $\sum_{i=1}^n (I_a + I_b + I_c)$ where n=512 samples	Amps	0.3 % of Reading +/- 0.15 % of FS
Net Current	Inet	Wye only	RMS of $\sum_{i=1}^n (I_a + I_b + I_c + I_d)$ where n=512 samples	Amps	0.4 % of Reading +/- 0.15 % of FS
Watts, Real Power	W-a	Wye, uses measured values Delta uses calculated phantom Neutral Values	$W = \frac{\sum_{i=1}^n (V \cdot I)}{512}$ where n=512 samples	Watts	0.2 % of Reading +/- 0.05 % of FS
	W-b				
	W-c				
	W-d				
	W-total		$W = W_a + W_b + W_c$		
Volt-Amps	VA-a	Wye, uses measured values Delta uses calculated phantom Neutral Values	$VA = V_{RMS} \times I_{RMS}$	VA	0.2 % of Reading +/- 0.05 % of FS
	VA-b				
	VA-c				
	VA-d				
	VA-total		$A = VA_a + VA_b + VA_c$		
Volt-Amps Reactive	VAR-a	Wye, uses measured values Delta uses calculated phantom Neutral Values	$VAR = V_{RMS-Fund} \times I_{RMS-Fund} \times \sin(\theta)$ Calculated using Fundamentals of V and I obtained from DFT	VAR	0.2 % of Reading +/- 0.05 % of FS
	VAR-b				
	VAR-c				
	VAR-d				
	VAR-total		$VAR\text{-Total} = VAR_a + VAR_b + VAR_c$		
Watts, Fundamental	Wf-a	Wye, uses measured values Delta uses calculated phantom Neutral Values	$W_{fund} = \frac{\sum_{i=1}^n V_{fund} \cdot I_{fund}}{512}$ where n=512 samples Waveform data derived from DFT	Watts	0.2 % of Reading +/- 0.05 % of FS
	Wf-b				
	Wf-c				
	Wf-d				
	Wf-total		$W_{fund\text{Total}} = W_{fund\ a} + W_{fund\ b} + W_{fund\ c}$		
VA Vector Total	VA-tot	Wye and Neutral based measurements	$VA_{vect\text{-tot}} = \sqrt{W_{fund\text{-tot}}^2 + VAR_{fund\text{-tot}}^2}$	VA	0.2 % of Reading +/- 0.05 % of FS

MAVOWATT 230, 240, 270 & 270-400 Power Quality Analyzers

Description	Abbreviation	Wiring Configuration	Formula	Units	Precision
VA Arithmetic Fundamental Total	VAfa-tot	Wye and Neutral based measurements	$= VAa_{fund} + VAb_{fund} + VAc_{fund}$	VA	0.2 % of Reading +/- 0.05 % of FS
True Power Factor	TPF-a	Wye, uses measured values Not meaningful for Delta	$PF = \frac{Watts}{VA}$	None	1% of Reading
	TPF-b				
	TPF-c				
	TPF-d				
Displacement Power Factor	DPF-a	Wye, uses measured values Not meaningful for Delta	$DPF = \cos(\varnothing_{volts} - \varnothing_{amps})$ DFT derived fundamental of Volts and Amps	None	1% of Reading
	DPF-b				
	DPF-c				
	DPF-d				
Phase of Volts to Amps of fundamental on individual cycle Derived from DFT	Vldeg-a	Not meaningful for Delta	$Vldeg = \delta_{vfa} - \delta_{ifa}$ $Vldeg = \delta_{vfb} - \delta_{ifb}$ $Ideg = \delta_{vfc} - \delta_{ifc}$ $Vldeg = \delta_{vfa} - \delta_{ifa}$ $f(t) = \sin \omega_n \tau + \delta_n$ where g= phase where n=1 for 1 st harmonic	Degree	+/- 1°
	Vldeg-b				
	Vldeg-c				
	Vldeg-d				
TPF worst case of A,B,C	TPFworst	Not meaningful for Delta	Max of 1- TPFa , 1- TPFb , 1- TPFc	None	+/- 1%
Total Vector Power Factor	TPFv-tot	All	$= \frac{W_{tot}}{VA_{tot-vect}}$	None	+/- 1%
Total Arithmetic Power Factor	TPFa-tot	All	$= \frac{W_{tot}}{VA_{tot-arithmetic}}$	None	+/- 1%
DPF average	DPFavg	All	$= \frac{DPFa + DPFb + DPFc}{3}$	None	+/- 1%
DPF worst case of A,B,C	DPFworst	All	DPF of channel with largest deviation from 1.0	None	+/- 1%

MAVOWATT 230, 240, 270 & 270-400 Power Quality Analyzers

Description	Abbreviation	Wiring Configuration	Formula	Units	Precision
Total Arithmetic Displacement Power Factor	DPFa-tot	All	$= \frac{W_{tot}}{VA_{tot-arithmetic}}$ <p>VA derived from DFT fundamental</p>	None	+/- 1 %
Total Vector Displacement Power Factor	DPFv-tot	All	$= \frac{W_{tot}}{VA_{tot-vect}}$ <p>VA derived from DFT fundamental</p>	None	+/- 1 %
Total Voltage Harmonic Distortion Normalized to the fundamental	HVthdfund-a	All	$= \frac{\sqrt{HV_2^2 + HV_3^2 - HV_{127}^2}}{HV_{fund}} * 100$ <p>Per 61000-4-7</p>	%	+/- 5 %
	HVthdfund-b				
	HVthdfund-c				
	HVthdfund-d				
	HVthdfund-ab				
	HVthdfund-bc				
	HVthdfund-ca				
Total Current Harmonic Distortion Normalized to the fundamental	Hlthdfund-a	All	$= \frac{\sqrt{HI_2^2 + HI_3^2 - HI_{63}^2}}{HI_{fund}} * 100$ <p>Per 61000-4-7</p>	%	+/- 5 %
	Hlthdfund-b				
	Hlthdfund-c				
	Hlthdfund-d				
Total Voltage InterHarmonic Distortion Normalized to the fundamental	HVtidfund-a	All	$= \frac{\sqrt{HigV_2^2 + HigV_3^2 - HigV_{127}^2}}{HV_{fund}} * 100$ <p>HigV is Voltage Inter-harmonic Group Per 61000-4-7</p>	%	+/- 5 %
	HVtidfund-b				
	HVtidfund-c				
	HVtidfund-d				
	HVtidfund-ab				
	HVtidfund-bc				
	HVtidfund-ca				
Total Current InterHarmonic Distortion Normalized to the fundamental	Hltidfund-a	All	$= \frac{\sqrt{Higl_2^2 + Higl_3^2 - Higl_{63}^2}}{HV_{fund}} * 100$ <p>Higl is Current Inter-harmonic Group Per 61000-4-7</p>	%	+/- 5 %
	Hltidfund-b				
	Hltidfund-c				
	Hltidfund-d				

MAVOWATT 230, 240, 270 & 270-400 Power Quality Analyzers

Description	Abbreviation	Wiring Configuration	Formula	Units	Precision
Total Voltage Harmonic Distortion Root Sum of Squares (RSS)	HVthdrss-a	All	$= \sqrt{HV_2^2 + HV_3^2 \dots HV_{127}^2}$ Per 61000-4-7	%	+/- 5 %
	HVthdrss-b				
	HVthdrss-c				
	HVthdrss-d				
	HVthdrss-ab				
	HVthdrss-bc				
	HVthdrss-ca				
Total Voltage Inter Harmonic Distortion Root Sum of Squares (RSS)	HVtldrss-a	All	= Higl is Voltage Inter-harmonic Group $\sqrt{HigV_2^2 + HigV_3^2 \dots HigV_{127}^2}$ Per 61000-4-7	%	+/- 5 %
	HVtldrss-b				
	HVtldrss-c				
	HVtldrss-d				
	HVtldrss-ab				
	HVtldrss-bc				
	HVtldrss-ca				
Total Odd Voltage Harmonic Distortion Normalized to the fundamental	HVohd-a	All	$= \frac{\sqrt{HV_3^2 + HV_5^2 - HV_{127}^2}}{HV_{fund}} * 100$ Per 61000-4-7	%	+/- 5 %
	HVohd-b				
	HVohd-c				
	HVohd-d				
	HVohd-ab				
	HVohd-bc				
	HVohd-ca				
Total Even Voltage Harmonic Distortion Normalized to the fundamental	HVe hd-a	All	$= \frac{\sqrt{HV_2^2 + HV_4^2 - HV_{126}^2}}{HV_{fund}} * 100$ Per 61000-4-7	%	+/- 5 %
	HVe hd-b				
	HVe hd-c				
	HVe hd-d				
	HVe hd-ab				
	HVe hd-bc				
	HVe hd-ca				
Total Current Odd Harmonic Distortion Normalized to the fundamental	Hlohd-a	All	$= \frac{\sqrt{HI_3^2 + HI_5^2 - HI_{63}^2}}{HV_{fund}} * 100$ Per 61000-4-7	%	+/- 5 %
	Hlohd-b				
	Hlohd-c				
	Hlohd-d				

MAVOWATT 230, 240, 270 & 270-400 Power Quality Analyzers

Description	Abbreviation	Wiring Configuration	Formula	Units	Precision
Total Current Even Harmonic Distortion Normalized to the fundamental	Hlehd-a	All	$\frac{\sqrt{HI_2^2 + HI_4^2 - HI_{E2}^2}}{HV_{fund}} * 100$	%	+/- 5 %
	Hlehd-b				
	Hlehd-c				
	Hlehd-d				
Telephone Influence Factor, normalized to Fundamental	HVtiffund-a	All	$TIF = \frac{\sqrt{\sum (X_f \cdot W_f)^2}}{X_{fund}}$ <p>where:</p> <p>X_{fund} = Total RMS of fund</p> <p>X_f = single frequency RMS at frequency f</p> <p>W_f = Single frequency weighing factor at frequency f</p> <p>Per IEEE 519/D7 1990 covers weighing factors up to 5 KHz</p>	None	+/- 1 %
	HVtiffund-b				
	HVtiffund-c				
	HVtiffund-d				
Telephone Influence Factor, normalized to RMS of input	HVtifrms-a	All	$TIF = \frac{\sqrt{\sum (x_f \cdot W_f)^2}}{x}$ <p>where:</p> <p>X = RMS of channel</p> <p>X_f = single frequency RMS at frequency f</p> <p>W_f = single frequency weighing factor at frequency f</p> <p>Per IEEE 519/D7 1990 covers weighing factors up to 5 KHz</p>	None	+/- 1 %
	HVtifrms-b				
	HVtifrms-c				
	HVtifrms-d				

MAVOWATT 230, 240, 270 & 270-400 Power Quality Analyzers

Description	Abbreviation	Wiring Configuration	Formula	Units	Precision
Total Harmonic unsigned power	Huspower-a	All	$= \sum_{n=2}^{63} V_n I_n \cos \phi_n $	Watts	+/- 5 %
	Huspower-b				
	Huspower-c				
	Huspower-d				
Total Harmonic signed power	Hspower-a	All	$= \left \sum_{n=2}^{63} V_n I_n \cos \phi_n \right $	Watts	+/- 5 %
	Hspower-b				
	Hspower-c				
	Hspower-d				
Transformer K Factor	Hlxfmrk-a	All	$K = \frac{\sum_{n=2}^{63} (H I_n^2 \cdot n^2)}{\sum_{n=2}^{63} H I_n^2}$	None	+/- 5 %
	Hlxfmrk-b				
	Hlxfmrk-c				
	Hlxfmrk-d				
Transformer De-Rating Factor	Hlxfmrdrat-a	All	$= \sqrt{\frac{P_{LLR}}{(1 + F_{HL} + P_{ECR})}}$ <p>Defined in IEEE C57.110-1998</p>	None	+/- 5 %
	Hlxfmrdrat-b				
	Hlxfmrdrat-c				
	Hlxfmrdrat-d				
Volts Under-Deviation	HVudev-a HVudev-b HVudev-c HVudev-d	All	$= \frac{V_{nom} - V_{rms}}{V_{nom}} * 100$ <p>If result is > V_{nom} then value is 0</p> <p>Where: V_{nom} is Declared Nominal Voltage V_{rms} is 200ms RMS per 61000-4-30</p>	%	+/- 1 %
	HVudev-ab HVudev-bc HVudev-ca				

MAVOWATT 230, 240, 270 & 270-400 Power Quality Analyzers

Description	Abbreviation	Wiring Configuration	Formula	Units	Precision
Volts Over-Deviation	HVodev-a HVodev-b HVodev-c HVodev-d	All	$= \frac{V_{rms} - V_{nom}}{V_{nom}} * 100$ <p>If result is < V_{nom} then value is 0</p> <p>Where: V_{nom} is Declared Nominal Voltage V_{rms} is 200 ms RMS Per 61000-4-30</p>	%	+/- 1 %
	HVodev-ab HVodev-bc HVodev-ca				
User Specified Frequencies		All	5 individually recorded frequencies derived from DFT expansion. User selectable in 5 Hz increments.	Volts or Amps	+/- .2 %
Main Signalling Frequencies		Volts only	5 individually recorded frequencies derived from DFT expansion. User selectable in 5 Hz increments.	Volts or Amps	+/- 5 % *
Individual Harmonic Voltages 0-127 0=DC		Volts	Computed according to 61000-4-7 using DFT over 200 mS window aggregated to selected journal inter- val as RMS	Volts	+/- 5 %
Individual Harmonic Current h0-63 h0=DC		Current	Computed according to 61000-4-7 using DFT over 200 mS window aggregated to selected journal inter- val as RMS	Amps	+/- 5 %
* from 3 % to 15 % of U _{din} , +/- 5 % of measured value, from 1 % to 3 % of U _{din} , +/- 0.15 % of U _{din}					

MAVOWATT 230, 240, 270 & 270-400 Power Quality Analyzers

Description	Abbreviation	Wiring Configuration	Formula	Units	Precision
Individual Inter Harmonic Voltages h:h+1 0-127 h0=DC		Volts	Computed according to 61000-4-7 using DFT over 200 mS window aggregated to selected journal inter- val as RMS	Volts	+/- 5 %
Individual Inter Harmonic Current h:h+1 0-63 h0=DC		Current	Computed according to 61000-4-7 using DFT over 200 mS window aggregated to selected journal inter- val as RMS	Amps	+/- 5 %
Instantaneous Flicker	Pinst-a	All	Compliant to 61000-4-15	None	+/- 8 %
	Pinst-b				
	Pinst-c				
	Pinst-ab				
	Pinst-bc				
	Pinst-ca				
Instantaneous Flicker Low Pass Filter output stage	Pinstlpf-a	All	Compliant to 61000-4-15 LPF - (1 minute TC)	None	+/- 8 %
	Pinstlpf-b				
	Pinstlpf-c				
	Pinstlpf-ab				
	Pinstlpf-bc				
	Pinstlpf-ca				
Instantaneous Flicker Square Root output stage	Pinstrt-a	All	Compliant to 61000-4-15 $= \sqrt{\frac{P_{inst}}{2}}$	None	+/- 8 %
	Pinstrt-b				
	Pinstrt-c				
	Pinstrt-ab				
	Pinstrt-bc				
	Pinstrt-ca				
Instantaneous Flicker Square Root output stage LPF	Pinstrtlpf-a	All	Compliant to 61000-4-15 LPF - (1 minute TC) $= \sqrt{\frac{P_{inst}}{2}}$	None	+/- 8 %
	Pinstrtlpf-b				
	Pinstrtlpf-c				
	Pinstrtlpf-ab				
	Pinstrtlpf-bc				
	Pinstrtlpf-ca				

MAVOWATT 230, 240, 270 & 270-400 Power Quality Analyzers

Description	Abbreviation	Wiring Configuration	Formula	Units	Precision
Short Term Flicker	Pst-a	All	Compliant to 61000-4-15	None	+/- 5 %
	Pst-b				
	Pst-c				
	Pst-ab				
	Pst-bc				
	Pst-ca				
Long Term Flicker	Plt-a	All	Compliant to 61000-4-15	None	+/- 5 %
	Plt-b				
	Plt-c				
	Plt-ab				
	Plt-bc				
	Plt-ca				
Long Term Flicker Slide	PltSlide-a	All	Compliant to 61000-4-15 Plt value computed every Pst interval (nominal 10 min)	None	+/- 5 %
	PltSlide-b				
	PltSlide-c				
	PltSlide-ab				
	PltSlide-bc				
	PltSlide-ca				
Current Demand	Idmd-a	All	Average Current of 1 sec readings over the user selected Demand interval	Amps	+/- 0.2 %
	Idmd-b				
	Idmd-c				
Peak Current Demand	lpk-a	All	Peak Current of 1 sec readings over the user selected Demand interval	Amps	+/- 0.2 %
	lpk-b				
	lpk-c				
Current Demand Average	Idmd-avg	Polyphase only	Average of Idmd-a, Idmd-b and Idmd-c for 3 phase. For Split phase, only A and B are averaged.	Amps	+/- 0.2 %
Peak Current Demand Average	lpk-avg	Polyphase only	Average of lpk-a, lpk- b and lpk-c for 3 phase. For Split phase, only A and B are averaged.	Amps	+/- 0.2 %
VA coincident with Peak Watts Demand	VAcow	All	VA Demand at time of Peak Watts, during a Demand interval	VA	+/- 0.5 %

MAVOWATT 230, 240, 270 & 270-400

Power Quality Analyzers

Description	Abbreviation	Wiring Configuration	Formula	Units	Precision
VAR coincident with Peak Watts Demand	VARcoW	All	VAR Demand at time of Peak Watts, during a Demand interval	VAR	+/- 0.5 %
Average True Power Factor coincident with Peak Watts Demand	PFavgcoW	All	Average True PF at time of Peak Watts, during a Demand interval	None	+/- 0.5 %
VA coincident with Peak VAR Demand	VAcovar	All	VA Demand at time of Peak VAR, during a Demand interval	VA	+/- 0.5 %
Watts coincident with Peak VAR Demand	Wcovar	All	Watts Demand at time of Peak VAR, during a Demand interval	Watts	+/- 0.5 %
Average True Power Factor coincident with Peak VAR Demand	PFavgcovar	All	Average True PF at time of Peak VAR, during a Demand interval	None	+/- 0.5 %
Watts coincident with Peak VA Demand	WcoVA	All	Watts Demand at time of Peak VA, during a Demand interval	Watts	+/- 0.5 %
VAR coincident with Peak VA Demand	VARcoVA	All	VAR Demand at time of Peak VA, during a Demand interval	VAR	+/- 0.5 %
Average True Power Factor coincident with Peak VA Demand	PFavgcoVA	All	Average True PF at time of Peak VA, during a Demand interval	None	+/- 15 %
Predicted Watts Demand	Wpred-tot	All	Prediction of Watts demand before interval is complete	Watts	NA
Predicted VAR Demand	VARpred-tot	All	Prediction of VAR demand before interval is complete	VAR	NA
Predicted VA Demand	VApred-tot	All	Prediction of VA demand before interval is complete	VA	NA

MAVOWATT 230, 240, 270 & 270-400 Power Quality Analyzers

Description	Abbreviation	Wiring Configuration	Formula	Units	Precision
Energy Watt-Hours	WHr-a	All	Sum of Watt readings each second scaled to Watt-Hours and accumulated into user selected interval.	Watt-h	+/- 0.22 %
	WHr-b				
	WHr-c				
	WHr-d				
	WHr-tot				
Energy VAR-Hours	VARHr-a	All	Sum of VAR readings each second scaled to VAR-Hours and accumulated into user selected interval.	VAR-h	+/- 0.22 %
	VARHr-b				
	VARHr-c				
	VARHr-d				
	VARHr-tot				
Energy VA-Hours	VAHr-a	All	Sum of VA readings each second scaled to VA-Hours and accumulated into user selected interval.	VA-h	+/- 0.22 %
	VAHr-b				
	VAHr-c				
	VAHr-d				
	VAHr-tot				
Energy Watt-Hours, Positive flow into load	WHrpos-a	All	Absolute value of Sum of each 1 second accumulation that has a positive value.	Watt-h	+/- 0.22 %
	WHrpos-b				
	WHrpos-c				
	WHrpos-d				
	WHrpos-tot				
Energy Watt- Hours, Negative flow into load	WHrneg-a	All	Absolute value of Sum of each 1 second accumulation that has a negative value.	Watt-h	+/- 0.22 %
	WHrneg-b				
	WHrneg-c				
	WHrneg-d				
	WHrneg-tot				
Energy VAR- Hours, Positive flow into load	VARHrpos-a	All	Absolute value of Sum of each 1 second accumulation that has a positive value.	VAR-h	+/- 0.22 %
	VARHrpos-b				
	VARHrpos-c				
	VARHrpos-d				
	VARHrpos-tot				
Energy VAR- Hours, Negative flow into load	VARHrneg-a	All	Absolute value of Sum of each 1 second accumulation that has a negative value.	VAR-h	+/- 0.22 %
	VARHrneg-b				
	VARHrneg-c				
	VARHrneg-d				
	VARHrneg-tot				

MAVOWATT 230, 240, 270 & 270-400 Power Quality Analyzers

Order Information

Type	Designation	Article Number
MAVOWATT 230	Including set of measurement cables (with 4x white measuring wires, 4x black measuring wires and 4x alligator clip), rechargeable battery, charger, Factory calibration certificate, DranView 7 Professional software and carrying pouch	M820A
MAVOWATT 230 Flex Package	MAVOWATT 230 with accessories (see above) and flexible current sensors: one METRAFLEX 3003XBL and one METRAFLEX 3001XBL	M820D
MAVOWATT 230 Mini Flex Package	MAVOWATT 230 with accessories (see above) and miniature current sensors: four METRAFLEX 300MXBL (3/30/300 A)	M820H
MAVOWATT 230 TR2510B Package	MAVOWATT 230 with accessories (see above) and current clamps: four TR251OB (1 ... 10 A)	M820N
MAVOWATT 240	Including Set of measurement cables (with 4x white measuring wires, 4x black measuring wires and 4x alligator clip), rechargeable battery, charger, Factory calibration certificate, DranView 7 Enterprise software and carrying pouch	M820B
MAVOWATT 240 Flex Package	MAVOWATT 240 with accessories (see above) and flexible current sensors: one METRAFLEX 3003XBL and one METRAFLEX 3001XBL	M820F
MAVOWATT 240 Mini Flex Package	MAVOWATT 240 with accessories (see above) and miniature current sensors: four METRAFLEX 300MXBL (3/30/300 A)	M820I
MAVOWATT 240 TR2510B Package	MAVOWATT 240 with accessories (see above) and current clamps: four TR251OB (1 ... 10 A)	M820O
MAVOWATT 270	Including set of measurement cables (with 4x white measuring wires, 4x black measuring wires and 4x alligator clip), rechargeable battery, charger, Factory calibration certificate, DranView 7 Enterprise software and carrying pouch	M820C
MAVOWATT 270 Flex Package	MAVOWATT 270 with accessories (see above) and flexible current sensors: one METRAFLEX 3003XBL and one METRAFLEX 3001XBL	M820G
MAVOWATT 270 Mini Flex Package	MAVOWATT 270 with accessories (see above) and miniature current sensors: four METRAFLEX 300MXBL (3/30/300 A)	M820J
MAVOWATT 270 TR2510B Package	MAVOWATT 270 with accessories (see above) and current clamps: four TR251OB (1 ... 10 A)	M820P
MAVOWATT 270-400	Including Set of measurement cables (with 4x white measuring wires, 4x black measuring wires and 4x alligator clip), rechargeable battery, charger, Factory calibration certificate, DranView 7 Enterprise software and carrying pouch	M820K
MAVOWATT 270-400 Flex Package	MAVOWATT 270-400 with accessories (see above) and flexible current sensors: one METRAFLEX 3003XBL and one METRAFLEX 3001XBL	M820L
MAVOWATT 270-400 Mini Flex Package	MAVOWATT 270-400 with accessories (see above) and miniature current sensors: four METRAFLEX 300MXBL (3/30/300 A)	M820M
MAVOWATT 270-400 TR2510B Package	MAVOWATT 270-400 with accessories (see above) and current clamps: four TR251OB (1 ... 10 A)	M820Q

For more details on accessories, please consult our homepage at:
www.gossenmetrawatt.com

Edited in Germany • Subject to change without notice • A PDF version is available on the Internet

X-ON Electronics

Largest Supplier of Electrical and Electronic Components

Click to view similar products for [Gossen Metrawatt](#) manufacturer:

Other Similar products are found below :

[1717V1260](#) [METRAMAX2](#) [METRAHIT WORLD](#) [METRAHIT AM BASE](#) [METRAHIT AM PRO](#) [METRISO PRO](#) [DUSPOL ANALOG](#)
[1000](#) [METRAPHASE 1](#) [METRAVOLT 12D +L](#) [PROFISAFE 690L](#) [METRACLIP 41/410 CASE](#) [METRAHIT AM XTRA](#) [1720V0050](#)
[METRACLIP 41](#) [DUSPOL DIGITAL 1000](#) [METRALINE DM62](#) [DUSPOL EXPERT 1000](#) [METRALINE DM41](#) [U528D](#) [METRALINE](#)
[DM61](#) [U270B](#)