

# PROFITEST MASTER IQ Series

## PROFITEST MTECH+, MPRO, MXTRA, SECULIFE IP

### DIN VDE 0100/IEC 60364-6 Testers

3-447-043-03  
2/7.19

#### Testing of residual current devices (RCCBs)

- Measurement of contact voltage without tripping the RCCB. Contact voltage is measured with reference to nominal residual current using 1/3 of the nominal residual current value.
- Testing for N-PE reversal
- Tripping test with nominal residual current, trip time measurement
- Testing of equipment and RCCBs with rising residual current including indication of tripping current and contact voltage
- Testing of RCCBs with nominal current of  $\frac{1}{2} \cdot I_{\Delta N}$ ,  $1 \cdot I_{\Delta N}$ ,  $2 \cdot I_{\Delta N}$ , ( $5 \cdot I_{\Delta N}$  to 300 mA: MPRO/MXTRA/SECULIFE IP to 100 mA: MTECH+)
- Intelligent ramp (**PROFITEST MXTRA** only): simultaneous measurement of breaking current  $I_{\Delta N}$  and breaking time  $t_A$
- Testing of selective **[S]** SRCDs, PRCDs (SCHUKOMAT, SIDOS or comparable), type G/R, type AC, type A, F; type B, B+ and type EV (except MPRO)
- Testing of RCCBs which are suitable for pulsating residual direct current; testing is conducted with positive or negative half-waves.
- Creation of test sequences (**IZYTRONIQ**)
- Intelligent data transmission  
Bidirectional interface to DDS-CAD for electrical planning 
- Simulation of operating states of electric vehicles at electric charging stations of different manufacturers (**MTECH+** and **MXTRA** only)

**DESIGN PLUS**

powered by: **light+building**



#### Large Voltage and Frequency Ranges

A broad-range measuring device allows for use of the test instrument in all alternating and 3-phase electrical systems with voltages from 65 to 500 V and frequencies of 16 to 400 Hz.

#### Loop and Line Impedance Measurement

Measurement of loop and line impedance can be performed in the 65 to 500 V range. Conversion to short-circuit current is based on the respective nominal line voltage, insofar as the measured line voltage is within the specified range. **PROFITEST MASTER** measuring error is also taken into account for conversion. Outside of this range, short-circuit current is calculated on the basis of momentary line voltage and measured impedance.

#### Measurement of Insulation Resistance Using Nominal Voltage, with Variable or Rising Test Voltage

Insulation resistance is usually measured with a nominal voltages of 500, 250 or 100 V. A test voltage which deviates from nominal voltage, and lies within a range of 20/50 to 1000 V, can be selected for measurements at sensitive components, as well as systems with voltage limiting devices.

Measurement can be performed with a constantly rising test voltage in order to detect weak points in the insulation and determine tripping voltage for voltage limiting devices.

Voltage at the device under test and any triggering/breakdown voltage appear at the test instrument's display.

#### Standing-Surface Insulation Measurement

Standing-surface insulation measurement is performed with momentary line frequency and line voltage.

#### Low-Resistance Measurement

Bonding conductor resistance and protective conductor resistance can be measured with a test current of  $\geq 200$  mA DC, automatic polarity reversal of the test voltage and selectable direction of current flow. If the adjustable limit value is exceeded, an LED lights up.

#### Earthing Resistance Measurement

In addition to measurement of the overall resistance of an earthing system, selective measurement of the earthing resistance of an individual earth electrode is also possible, without having to disconnect it from the earthing system. A current clamp sensor available as an accessory is utilized to this end.

Furthermore, the **PROFITEST MPRO** and the **PROFITEST MXTRA** allow for battery powered earthing resistance measurements: 3/4-pole and earth loop resistance measurements.

#### Universal Connector System

The interchangeable plug inserts and 2-pole plug-in adapter – which can be expanded to 3-poles for phase sequence testing – allows for use of the test instrument all over the world.

#### Special Features

- Display of approved fuse types for electrical systems
- Energy meter start-up testing
- Measurement of biasing, leakage and circulating current of up to 1 A, as well as working current of up to 1000 A with current clamp sensor (available as an accessory)
- Phase sequence measurement (including highest line-to-line voltage)
- Optional connection of a Bluetooth keyboard (Logitech) and a Bluetooth barcode reader in preparation

# PROFITEST MTECH+, MPRO, MXTRA, SECULIFE IP

## DIN VDE 0100/IEC 60364-6 Testers

### Display with Selectable Language

The LCD panel consists of a backlit dot matrix at which menus, setting options, measurement results, tables, instructions and error messages, as well schematic diagrams appear.

The display can be set to the desired language depending on the country in which the test instrument is used:

D, GB, I, F, E, P, NL, S, N, FIN, CZ or PL

### Operation

Device functions are selected directly with the help of a rotary selector knob. Softkeys allow for convenient selection of sub-functions and parameter settings. Unavailable functions and parameters are automatically prevented from appearing at the display.

The start and RCD tripping functions included directly on the instrument are identical to the functions of the two keys located on the test plug, allowing for easy measurement at difficult to access locations.

Schematic diagrams, measuring ranges and help texts can be displayed for all basic functions and sub-functions.

### Phase Tester

Protective conductor potential is tested after starting a test sequence and touching the contact surface for finger contact. The PE symbol appears at the display if a potential difference of more than 25 V is detected between the contact surface and the protective contact at the mains plug.

### Error Indication

- The instrument automatically detects **instrument-to-system connection errors**, which are indicated in a connection pictograph.
- **Errors within the electrical system** (no mains or phase voltage, tripped RCD) are indicated at 3 LEDs and by means of pop-up windows at the tilting LCD panel.

### Battery Monitoring and Self-Test

Battery monitoring is conducted while the instrument is subjected to an electrical load. Results are displayed both numerically and with a symbol. Test images can be called up one after the other, and LEDs can be tested during the self-test. The instrument is shut down automatically when the rechargeable batteries are discharged. A microprocessor controlled charging circuit is used to assure safe charging of rechargeable NiMH or NiCd batteries.

### Data Entry at the RS 232 Port

Data can be read in via a barcode or RFID scanner connected to the RS 232 port, and comments can be entered with the help of the softkeys.

### IZYTRONIQ User Software for PC

IZYTRONIQ is a test software developed from scratch. It enables the user to visualize and manage the entire testing procedure for all our test instruments and to document it in an audit-proof manner. For the first time, it is thus possible to combine the test and measurement data from a great variety of test instruments and multimeters in one test and generate one report thereof. The intuitive user guidance and modern design provide for quick access to all functions.

The software is available in different sizes and versions for trades, industry and vocational training purposes.

### Overview of Features Included with PROFITEST MASTER & SECULIFE IP Device Variants

PROFITEST ... (Article Number)	MPRO (M535C)	MTECH+ (M535B)	MXTRA (M535D)	SECULIFE IP (M535E)
<b>Testing of residual current devices (RCDs)</b>				
<b>U<sub>B</sub> measurement without tripping RCD</b>	✓	✓	✓	✓
<b>Tripping time measurement</b>	✓	✓	✓	✓
<b>Measurement of tripping current I<sub>F</sub></b>	✓	✓	✓	✓
<b>Selective, SRCDS, PRCDS, type G/R</b>	✓	✓	✓	✓
<b>AC/DC sensitive RCDs, type B, B+</b>	—	✓	✓	✓
<b>Testing of IMDs</b>	—	—	✓	✓
<b>Testing of RCMs</b>	—	—	✓	—
<b>Testing for N-PE reversal</b>	✓	✓	✓	✓
<b>Measurement of loop impedance Z<sub>L-PE</sub> / Z<sub>L-N</sub></b>				
Fuse table for systems without RCDs	✓	✓	✓	✓
Without tripping the RCD, fuse table	—	✓	✓	✓
With 15 mA test current <sup>1)</sup> without tripping the RCD	✓	✓	✓	✓
<b>Earthing resistance R<sub>E</sub> (mains operation)</b>				
I-U measuring method (2/3-wire measuring method via measuring adapter: 2-wire/2-wire + probe)	✓	✓	✓	✓
<b>Earthing resistance R<sub>E</sub> (battery operation)</b>				
3 or 4-wire measurement via PRO-RE adapter	✓	—	✓	—
<b>Soil resistivity ρ<sub>E</sub> (battery operation)</b>				
(4-wire measurement via PRO-RE adapter)	✓	—	✓	—
<b>Selective earthing resistance R<sub>E</sub> (mains operation)</b>				
with 2-pole adapter, probe, earth electrode and current clamp sensor (3-wire measuring method)	✓	✓	✓	✓
<b>Selective earthing resistance R<sub>E</sub> (battery operation)</b>				
with probe, earth electrode and current clamp sensor (4-wire measuring method via PRO-RE adapter and current clamp sensor)	✓	—	✓	—
<b>Earth loop resistance R<sub>ELOOP</sub> (battery operation)</b>				
with 2 clamps (current clamp sensor direct and current clamp transformer via PRO-RE/2 adapter)	✓	—	✓	—
<b>Measurement of equipotential bonding R<sub>LO</sub>, automatic polarity reversal</b>				
Insulation resistance R <sub>ISO</sub> , variable or rising test voltage (ramp)	✓	✓	✓	✓
<b>Voltage U<sub>L-N</sub> / U<sub>L-PE</sub> / U<sub>N-PE</sub> / f</b>	✓	✓	✓	✓
<b>Special measurements</b>				
<b>Leakage current (with clamp) I<sub>L</sub>, I<sub>AMP</sub></b>	✓	✓	✓	✓
<b>Phase sequence</b>	✓	✓	✓	✓
<b>Earth leakage resistance R<sub>E(ISO)</sub></b>	✓	✓	✓	✓
<b>Voltage drop (ΔU)</b>	✓	✓	✓	✓
<b>Standing-surface insulation Z<sub>ST</sub></b>	✓	✓	✓	✓
<b>Meter start-up (kWh-Test)</b>	✓	✓	✓	—
<b>Leakage current with PRO-AB adapter (IL)</b>	—	—	✓	✓
<b>Residual voltage test (Ures)</b>	—	—	✓	—
<b>Intelligent ramp (ta + ΔI)</b>	—	—	✓	—
<b>Electric vehicles at charging stations (IEC 61851)</b>	—	✓	✓	—
<b>Report generation of fault simulations on PRCDS with PROFITEST PRCD adapter</b>	—	—	✓	—
<b>Features</b>				
<b>Selectable user interface language <sup>2)</sup></b>	✓	✓	✓	✓
<b>Memory (database for up to 50,000 objects)</b>	✓	✓	✓	✓
<b>Automatic test sequence function</b>	✓	✓	✓	✓
<b>RS 232 port for RFID/barcode scanner</b>	✓	✓	✓	✓
<b>USB port for data transmission</b>	✓	✓	✓	✓
<b>Interface for Bluetooth®</b>	—	✓	✓	✓
<b>IZYTRONIQ BUSINESS Starter database and report software for PC</b>	✓	✓	✓	✓
<b>Measuring category: CAT III 600 V / CAT IV 300 V</b>	✓	✓	✓	✓
<b>DAkKS calibration</b>	✓	✓	✓	✓

<sup>1)</sup> So-called live measurement is only advisable if there is no bias current within the system. Only suitable for motor circuit breaker with low nominal current.

<sup>2)</sup> Currently available languages: D, GB, I, F, E, P, NL, S, N, FIN, CZ, PL

# PROFITEST MTECH+, MPRO, MXTRA, SECULIFE IP DIN VDE 0100/IEC 60364-6 Testers

## Data Interface

Measurement data are transmitted to a PC via the integrated USB port, at which they can be printed in report form and archived.

## Software update

The test instrument is always kept current thanks to firmware which can be updated via the USB port. Software is updated during the course of recalibration by our service department, or directly by the customer.

## Sample Displays

### PROFITEST MASTER and SECULIFE IP Test Instruments

Softkeys allow for convenient selection of sub-functions and parameter settings. Unavailable sub-functions and parameters are automatically prevented from appearing at the display.

RCD Measurement

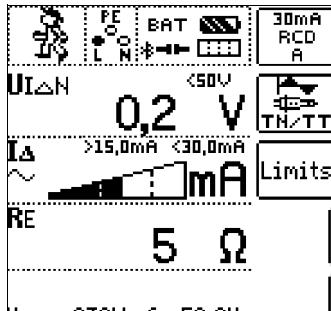

Loop Resistance Measurement

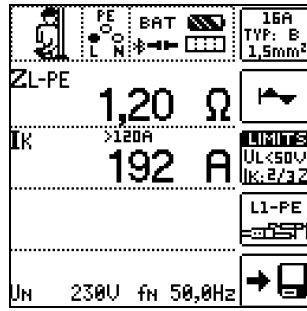

Earthing Resistance Measurement

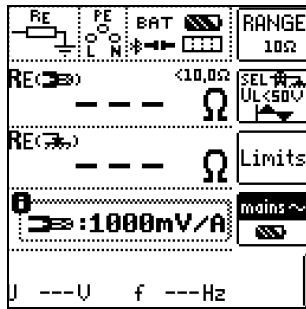

Low-Resistance Measurement

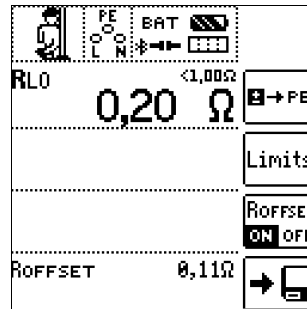

Insulation Measurement

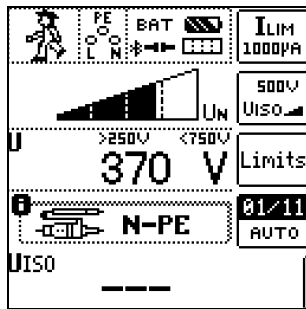

Voltage Measurement

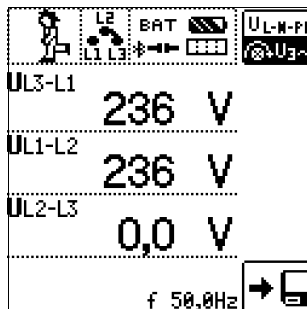

The above sample displays are taken from the PROFITEST MTECH+ instruments.

## Applicable Regulations and Standards

IEC 61010-1 / EN 61010-1/ VDE 0411-1	Safety requirements for electrical equipment for measurement, control and laboratory use Part 1: General requirements (IEC 61010-1:2010 + Cor.:2011) Part 31: Safety requirements for hand-held probe assemblies for electrical measurement and test (IEC 61010-031:2002 + A1:2008)
IEC 61557/ EN 61557/ VDE 0413	Part1: General requirements (IEC 61557-1:2007) Part 2: Insulation resistance (IEC 61557-2:2007) Part 3: Loop impedance (IEC 61557-3:2007) Part 4: Resistance of earth connection and equipotential bonding (IEC 61557-4:2007) Part 5: Resistance to earth (IEC 61557-5:2007) Part 6: Effectiveness of residual current devices (RCD) in TT, TN and IT systems (IEC 61557-6:2007) Part 7: Phase sequence (IEC 61557-7:2007) Part 10:Electrical safety in low voltage distribution systems up to 1000 V AC and 1500 V DC – Equipment for testing, measuring or monitoring of protective measures (IEC 61557-10:2000) Part 11:Effectiveness of residual current monitors (RCMs) type A and type B in TT, TN and IT systems (IEC 61557-11:2009) (PROFITEST MXTRA only)
EN 60529 VDE 0470, part 1	Test instruments and test procedures Degrees of protection provided by enclosures (IP code)
DIN EN 61326-1 VDE 0843-20-1	Electrical equipment for measurement, control and laboratory use – EMC requirements – Part 1: General requirements
IEC 60364-6-61 VDE 0100, part 600	Low-voltage electrical installations – Part 6: Tests
IEC 60364-6-62 EN 50110-1 VDE 0105, part 100	Operation of electrical installations – Part 100: General requirements
IEC 60364-7-710 VDE 0100, part 710	Erection of low-voltage installations – Requirements for special installations or locations – Part 710: Medical locations
IEC 61851-1 DIN EN 61851-1	Electric vehicle conductive charging system – Part 1: General requirements

## Characteristic Values







### Nominal Ranges of Use

Voltage $U_N$	120 V (108 ... 132 V)
	230 V (196 ... 253 V)
	400 V (340 ... 440 V)
Frequency $f_N$	16 $\frac{2}{3}$ Hz (15.4 ... 18 Hz)
	50 Hz (49.5 ... 50.5 Hz)
	60 Hz (59.4 ... 60.6 Hz)
	200 Hz (190 ... 210 Hz)
	400 Hz (380 ... 420 Hz)
Overall voltage range	65 ... 550 V
Overall frequency range	15.4 ... 420 Hz
Waveform	sine
Temperature range	0° C ... + 40° C
Battery voltage	8 ... 12 V
Line impedance angle	Corresponds to $\cos\phi = 1 \dots 0.95$
Probe resistance	< 50 kΩ

# PROFITEST MTECH+, MPRO, MXTRA, SECULIFE IP

## DIN VDE 0100/IEC 60364-6 Testers

### Characteristic Values PROFITEST MTECH+

Function	Measured Quantity	Display Range	Resolution	Input Impedance/ Test Current	Measuring Range	Nominal Values	Measuring Uncertainty	Intrinsic Uncertainty	Connections							
									Plug Insert 1	2-Pole Adapter	3-Pole Adapter	Probe	WZ12C	Clamps Z3512A	MFLEX P300	
U	$U_{L-PE}$ $U_{N-PE}$	0 ... 99.9 V 100 ... 600 V	0.1 V 1 V	5 M $\Omega$	0.3 ... 600 V <sup>1)</sup>	$U_N = 120/230/400/500$ V $f_N = 16^{2/3}/50/60/200/400$ Hz	$\pm(2\% \text{ rdg.} + 5d)$ $\pm(2\% \text{ rdg.} + 1d)$	$\pm(1\% \text{ rdg.} + 5d)$ $\pm(1\% \text{ rdg.} + 1d)$	●	●	●					
	f	15.0 ... 99.9 Hz 100 ... 999 Hz	0.1 Hz 1 Hz		DC 15,4 ... 420 Hz		$\pm(0.2\% \text{ rdg.} + 1d)$	$\pm(0.1\% \text{ rdg.} + 1d)$								
	$U_{3-}$	0 ... 99.9 V 100 ... 600 V	0.1 V 1 V		0.3 ... 600 V		$\pm(3\% \text{ rdg.} + 5d)$ $\pm(3\% \text{ rdg.} + 1d)$	$\pm(2\% \text{ rdg.} + 5d)$ $\pm(2\% \text{ rdg.} + 1d)$			●					
	$U_{PROBE}$	0 ... 99.9 V 100 ... 600 V	0.1 V 1 V		1.0 ... 600 V		$\pm(2\% \text{ rdg.} + 5d)$ $\pm(2\% \text{ rdg.} + 1d)$	$\pm(1\% \text{ rdg.} + 5d)$ $\pm(1\% \text{ rdg.} + 1d)$			●					
	$U_{L-N}$	0 ... 99.9 V 100 ... 600 V	0.1 V 1 V		1.0 ... 600 V <sup>1)</sup>		$\pm(3\% \text{ rdg.} + 5d)$ $\pm(3\% \text{ rdg.} + 1d)$	$\pm(2\% \text{ rdg.} + 5d)$ $\pm(2\% \text{ rdg.} + 1d)$	●		●					
$I_{\Delta N}$ $I_F$	$U_{I_{\Delta N}}$	0 ... 70.0 V	0.1 V	0.3 · $I_{\Delta N}$	5 ... 70 V	$U_N = 120/230/400$ V <sup>2)</sup> $f_N = 50/60$ Hz $U_L = 25/50$ V $I_{\Delta N} = 6/10/30/100/300/500$ mA <sup>2)</sup>	+10% rdg.+1d	+1% rdg.-1d ... +9% rdg.+1d								
	$R_E$	10 $\Omega$ ... 999 $\Omega$ 1.00 k $\Omega$ ... 6.51 k $\Omega$	1 $\Omega$ 0.01 k $\Omega$	calculated value from $U_{I_{\Delta N}} / I_{\Delta N}$	$I_{\Delta N} = 10 \text{ mA} \cdot 1,05$											
		3 $\Omega$ ... 999 $\Omega$ 1 k $\Omega$ ... 2.17 k $\Omega$	1 $\Omega$ 0.01 k $\Omega$		$I_{\Delta N} = 30 \text{ mA} \cdot 1,05$											
		1 $\Omega$ ... 651 $\Omega$	1 $\Omega$		$I_{\Delta N} = 100 \text{ mA} \cdot 1,05$											
		0.3 $\Omega$ ... 99.9 $\Omega$ 100 $\Omega$ ... 217 $\Omega$	0.1 $\Omega$ 1 $\Omega$		$I_{\Delta N} = 300 \text{ mA} \cdot 1,05$											
		0.2 $\Omega$ ... 9.9 $\Omega$ 10 $\Omega$ ... 130 $\Omega$	0.1 $\Omega$ 1 $\Omega$		$I_{\Delta N} = 500 \text{ mA} \cdot 1,05$											
	$I_F (I_{\Delta N} = 6 \text{ mA})$ $I_F (I_{\Delta N} = 10 \text{ mA})$ $I_F (I_{\Delta N} = 30 \text{ mA})$ $I_F (I_{\Delta N} = 100 \text{ mA})$ $I_F (I_{\Delta N} = 300 \text{ mA})$ $I_F (I_{\Delta N} = 500 \text{ mA})$	1.8 ... 7.8 mA 3.0 ... 13.0 mA 9.0 ... 39.0 mA 30 ... 130 mA 90 ... 390 mA 150 ... 650 mA	0,1 mA	1.8 ... 7.8 mA 3.0 ... 13.0 mA 9.0 ... 39.0 mA 30 ... 130 mA 90 ... 390 mA 150 ... 650 mA	1.8 ... 7.8 mA 3.0 ... 13.0 mA 9.0 ... 39.0 mA 30 ... 130 mA 90 ... 390 mA 150 ... 650 mA				$\pm(5\% \text{ rdg.} + 1d)$	$\pm(3.5\% \text{ rdg.} + 2d)$						
	$U_{I_{\Delta}} / U_L = 25$ V $U_{I_{\Delta}} / U_L = 50$ V	0 ... 25.0 V 0 ... 50.0 V	0.1 V	wie $I_{\Delta}$	0 ... 25.0 V 0 ... 50.0 V				+10% rdg.+1d	+1% rdg.-1d ... +9% rdg.+1d						
	$t_A (I_{\Delta N} \cdot 1)$ $t_A (I_{\Delta N} \cdot 2)$ $t_A (I_{\Delta N} \cdot 5)$	0 ... 1000 ms 0 ... 1000 ms 0 ... 40 ms	1 ms	6 ... 500 mA 2 · 6 ... 2 · 500 mA 5 · 6 ... 5 · 300 mA	0 ... 1000 ms 0 ... 1000 ms 0 ... 40 ms				$\pm 4$ ms	$\pm 3$ ms						
	$Z_{L-PE}$ $Z_{L-N}$	$Z_{L-PE}$ (  ) $Z_{L-N}$	0 ... 999 m $\Omega$ 1.00 ... 9.99 $\Omega$	1 m $\Omega$ 0.01 $\Omega$	1.3 ... 3.7 A AC 0.5/1.25 A DC		0.15 ... 0.49 $\Omega$ 0.50 ... 0.99 $\Omega$ 1.00 ... 9.99 $\Omega$	$U_N = 120/230/400/500$ V <sup>1)</sup> $f_N = 16^{2/3}/50/60$ Hz	$\pm(10\% \text{ rdg.} + 30d)$ $\pm(10\% \text{ rdg.} + 30d)$ $\pm(5\% \text{ rdg.} + 3d)$	$\pm(5\% \text{ rdg.} + 30d)$ $\pm(4\% \text{ rdg.} + 30d)$ $\pm(3\% \text{ rdg.} + 3d)$						
		$Z_{L-PE} + DC$ (  )	0 ... 999 m $\Omega$ 1.00 ... 9.99 $\Omega$ 10.0 ... 29.9 $\Omega$	0.1 $\Omega$			0.25 ... 0.99 $\Omega$ 1.00 ... 9.99 $\Omega$	$U_N = 120/230/400/500$ V <sup>1)</sup> $f_N = 50/60$ Hz	$\pm(18\% \text{ rdg.} + 30d)$ $\pm(10\% \text{ rdg.} + 3d)$	$\pm(6\% \text{ rdg.} + 50d)$ $\pm(4\% \text{ rdg.} + 3d)$			●	●		
		$I_K (Z_{L-PE} + DC)$ (  )	0 ... 9.9 A 10 ... 99.9 A	0,1 A 1 A			120 (108 ... 132) V 230 (196 ... 253) V 400 (340 ... 440) V 500 (450 ... 550) V		calculated value from $Z_{L-PE}$							
		$Z_{L-PE} + DC$ (  )	0.5 ... 9.99 $\Omega$	0.01 $\Omega$			only display range									
$Z_{L-PE}$ (15 mA)		10.0 ... 99.9 $\Omega$ 100 ... 999 $\Omega$	0.1 $\Omega$ 1 $\Omega$	10 ... 100 $\Omega$ 100 ... 1000 $\Omega$		$U_N = 120/230$ V $f_N = 16^{2/3}/50/60$ Hz	$\pm(10\% \text{ rdg.} + 10d)$ $\pm(8\% \text{ rdg.} + 2d)$	$\pm(2\% \text{ rdg.} + 2d)$ $\pm(1\% \text{ rdg.} + 1d)$								
$I_K$ (15 mA)	100 ... 999 mA 0.00 ... 9.99 A 10.0 ... 99.9 A	1 mA 0.01 A 0.1 A	15 mA AC	calculated value depends on $U_N$ and $Z_{L-PE}$ : $I_K = U_N / Z_{L-PE} (15 \text{ mA})$												
$R_E$	$R_E$ (with probe)	0 ... 999 m $\Omega$ 1.00 ... 9.99 $\Omega$ 10.0 ... 99.9 $\Omega$ 100 ... 999 $\Omega$ 1 k $\Omega$ ... 9.99 k $\Omega$	1 m $\Omega$ 0.01 $\Omega$ 0.1 $\Omega$ 1 $\Omega$ 0.01 k $\Omega$	1.3 ... 3.7 A AC 1.3 ... 3.7 A AC 1.3 ... 3.7 A AC 40 mA AC 4 mA AC	0.15 $\Omega$ ... 0.49 $\Omega$ 0.50 $\Omega$ ... 0.99 $\Omega$ 1.0 $\Omega$ ... 9.99 $\Omega$ 10 $\Omega$ ... 99.9 $\Omega$ 100 $\Omega$ ... 999 $\Omega$ 1 k $\Omega$ ... 9.99 k $\Omega$	$U_N = 120/230/400$ V $U_N = 400$ V <sup>1)</sup> $f_N = 50/60$ Hz	$\pm(10\% \text{ rdg.} + 30d)$ $\pm(10\% \text{ rdg.} + 30d)$ $\pm(5\% \text{ rdg.} + 3d)$ $\pm(10\% \text{ rdg.} + 3d)$ $\pm(10\% \text{ rdg.} + 3d)$ $\pm(10\% \text{ rdg.} + 3d)$	$\pm(5\% \text{ rdg.} + 30d)$ $\pm(4\% \text{ rdg.} + 30d)$ $\pm(3\% \text{ rdg.} + 3d)$ $\pm(3\% \text{ rdg.} + 3d)$ $\pm(3\% \text{ rdg.} + 3d)$ $\pm(3\% \text{ rdg.} + 3d)$	●	●						
	$R_E$ DC+ (  )	0 ... 999 m $\Omega$ 1.00 ... 9.99 $\Omega$ 10.0 ... 29.9 $\Omega$	1 m $\Omega$ 0.01 $\Omega$ 0.1 $\Omega$	1.3 ... 3.7 A AC 0.5/1.25 A DC	0.25 ... 0.99 $\Omega$ 1.00 ... 9.99 $\Omega$	$U_N = 120/230/400/500$ V <sup>1)</sup> $f_N = 50/60$ Hz	$\pm(18\% \text{ rdg.} + 30d)$ $\pm(10\% \text{ rdg.} + 3d)$	$\pm(6\% \text{ rdg.} + 50d)$ $\pm(4\% \text{ rdg.} + 3d)$								
	$U_E$	0 ... 253 V	1 V	—	calculated value											
	$R_E$ Sel clip	$R_E$	0 ... 999 $\Omega$	1 m $\Omega$ ... 1 $\Omega$	1.3 ... 3.7 A AC 0.5/1.25 A DC	0.25 ... 300 $\Omega$ <sup>5)</sup>	see $R_E$	$\pm(20\% \text{ rdg.} + 20 d)$	$\pm(15\% \text{ rdg.} + 20 d)$				●			
$R_E$ DC+ (  )		0 ... 999 $\Omega$	1 m $\Omega$ ... 1 $\Omega$			$U_N = 120/230/400/500$ V $f_N = 50/60$ Hz	$\pm(22\% \text{ rdg.} + 20 d)$	$\pm(15\% \text{ rdg.} + 20 d)$					●			
EX-TRA	$Z_{ST}$	10 k $\Omega$ ... 199 k $\Omega$ 200 k $\Omega$ ... 999 k $\Omega$ 1.00 M $\Omega$ ... 9.99 M $\Omega$ 10.0 M $\Omega$ ... 30.0 M $\Omega$	1 k $\Omega$ 1 k $\Omega$ 0.01 M $\Omega$ 0.1 M $\Omega$	2.3 mA bei 230 V	10 k $\Omega$ ... 199 k $\Omega$ 200 k $\Omega$ ... 999 k $\Omega$ 1.00 M $\Omega$ ... 9.99 M $\Omega$ 10.0 M $\Omega$ ... 30.0 M $\Omega$	$U_0 = U_{L-N}$	$\pm(20\% \text{ v.M.} + 2D)$	$\pm(10\% \text{ v.M.} + 3D)$	●	●	●	●				

# PROFITEST MTECH+, MPRO, MXTRA, SECULIFE IP DIN VDE 0100/IEC 60364-6 Testers

Function	Measured Quantity	Display Range	Resolution	Test Current	Measuring Range	Nominal Values	Measuring Uncertainty	Intrinsic Uncertainty	Connections									
									Plug Insert <sup>1</sup>	2-Pole Adapter	3-Pole Adapter	Clamps						
										WZ12C	Z3512A	MFLEX P300	CP1100					
R <sub>INS</sub>	R <sub>INS</sub> , R <sub>EINS</sub>	1 ... 999 kΩ 1.00 ... 9.99 MΩ 10.0 ... 49.9 MΩ	1 kΩ 10 kΩ 100 kΩ	I <sub>k</sub> = 1.5 mA	50 ... 999 kΩ 1.00 ... 49.9 MΩ	U <sub>N</sub> = 50 V I <sub>N</sub> = 1 mA	kΩ range ±(5% rdg.+10d)	kΩ range ±(3% rdg.+10d)	●	●								
		1 ... 999 kΩ 1.00 ... 9.99 MΩ 10.0 ... 99.9 MΩ	1 kΩ 10 kΩ 100 kΩ		50 ... 999 kΩ 1.00 ... 99.9 MΩ	U <sub>N</sub> = 100 V I <sub>N</sub> = 1 mA												
		1 ... 999 kΩ 1.00 ... 9.99 MΩ 10.0 ... 200 MΩ	1 kΩ 10 kΩ 1 MΩ		50 ... 999 kΩ 1.00 ... 200 MΩ	U <sub>N</sub> = 250 V I <sub>N</sub> = 1 mA	MΩ range ±(5% rdg.+1d)	MΩ range ±(3% rdg.+1d)										
		1 ... 999 kΩ 1.00 ... 9.99 MΩ 10.0 ... 99.9 MΩ 100 ... 500 MΩ	1 kΩ 10 kΩ 100 kΩ 1 MΩ		50 ... 999 kΩ 1.00 ... 499 MΩ	U <sub>N</sub> = 325 V U <sub>N</sub> = 500 V U <sub>N</sub> = 1000 V I <sub>N</sub> = 1 mA												
U		10 ... 999 V 1.00 ... 1.19 kV	1 V 10 V		10 ... 1.19 kV		±(3% rdg.+1d)	±(1.5% rdg.+1d)										
R <sub>LO</sub>	R <sub>LO</sub>	0.00 Ω ... 9.99 Ω 10.0 Ω ... 99.9 Ω	10 mΩ 100 mΩ	I <sub>m</sub> ≥ 200 mA I <sub>m</sub> < 200 mA	0.1 Ω ... 5.99 Ω 6.0 Ω ... 100 Ω	U <sub>0</sub> = 4.5 V	±(4% rdg.+2d)	±(2% rdg.+2d)		●								
				Transformation ratio <sup>3</sup>			5	5										
SEN- SOR 6 7	I <sub>L/Amp</sub>	0.0 ... 99.9 mA 100 ... 999 mA 1.00 ... 9.99 A 10.0 ... 15.0 A 1.00 ... 9.99 A 10.0 ... 99.9 A 100 ... 150 A	0.1 mA 1 mA 0.01 A 0.1 A 0.01 A 0.1 A 1 A	1 V/A	5 ... 15 A	f <sub>N</sub> = 50/60 Hz	±(13% rdg.+5d)	±(5% rdg.+4d)										
		±(13% rdg.+1d)	±(5% rdg.+1d)				I 15A											
		±(11% rdg.+4d)	±(4% rdg.+3d)															
		±(11% rdg.+1d)	±(4% rdg.+1d)															II 150A
		0.0 ... 99.9 mA 100 ... 999 mA 1.00 ... 9.99 A 10.0 ... 99.9 A 10.0 ... 99.9 A 100 ... 999 A	0.1 mA 1 mA 0.01 A 0.1 A 0.01 A 0.1 A	1 V/A	5 ... 1000 mA	100 mV/A	0.05 ... 10 A	f <sub>N</sub> = 16.7/50/60/200/400 Hz	±(7% rdg.+2 d)	±(5% rdg.+2 d)								
		±(7% rdg.+1 d)	±(5% rdg.+1 d)						1 A									
		±(3.4% rdg.+2 d)	±(3% rdg.+2 d)															
		±(3.1% rdg.+2 d)	±(3% rdg.+2 d)															
		±(3.1% rdg.+1 d)	±(3% rdg.+1 d)															
		±(3.1% rdg.+1 d)	±(3% rdg.+1 d)															
		±(3.1% rdg.+2 d)	±(3% rdg.+2 d)															
		±(3.1% rdg.+1 d)	±(3% rdg.+1 d)															
		0.0 ... 99.9 mA 100 ... 999 mA	0.1 mA 1 mA	1 V/A	30 ... 1000 mA	100 mV/A	0.3 ... 10 A	f <sub>N</sub> = 50/60 Hz	±(27% rdg.+100 d)	±(3% rdg.+100 d)								
		±(27% rdg.+11 d)	±(3% rdg.+11 d)						0.03									
		±(27% rdg.+12 d)	±(3% rdg.+12 d)															
		±(27% rdg.+11 d)	±(3% rdg.+11 d)															
±(27% rdg.+100 d)	±(3% rdg.+100 d)																	
±(27% rdg.+11 d)	±(3% rdg.+11 d)																30	
±(27% rdg.+11 d)	±(3% rdg.+11 d)																	
±(27% rdg.+11 d)	±(3% rdg.+11 d)																3	
±(27% rdg.+11 d)	±(3% rdg.+11 d)																	
±(27% rdg.+11 d)	±(3% rdg.+11 d)																300	
0.00 ... 9.99 A 10.0 ... 99.9 A 10.0 ... 99.9 A 100 ... 999 A	0.01 A 0.1 A 0.01 A 1 A	10 mV/A	0.5 ... 100 A	10 mV/A	5 ... 1000 A	f <sub>N</sub> = DC/16.7/50/60/200 Hz	±(5% rdg.+12 d)	±(3% rdg.+12 d)										
±(5% rdg.+2 d)	±(3% rdg.+2 d)						100A											
±(5% rdg.+50 d)	±(3% rdg.+50 d)																	
±(5% rdg.+7 d)	±(3% rdg.+7 d)																1000A	
±(5% rdg.+2 d)	±(3% rdg.+2 d)																	

- <sup>1</sup> U > 253 V, with 2 or 3-pole adapter only
- <sup>2</sup> 1/2 · IΔN > 300 mA and 5 · IΔN > 500 mA and If > 300 mA only up to U<sub>N</sub> ≤ 230 V!  
IΔN 5 · 300 mA only with U<sub>N</sub> = 230 V
- <sup>3</sup> The transformation ratio selected at the clamp (1 ... 1000 mV/A) must be set in the "Type" menu with the rotary switch in the "SENSOR" position.
- <sup>4</sup> at R<sub>Eselektiv</sub>/R<sub>Egesamt</sub> < 100
- <sup>5</sup> the indicated measuring and intrinsic uncertainties already include the uncertainties of the respective current clamp.
- <sup>6</sup> Measuring range of the signal input at the test instrument U<sub>E</sub>: 0 ... 1.0 V<sub>eff</sub> (0 ... 1.4 V<sub>peak</sub>) AC/DC
- <sup>7</sup> Input impedance of signal input at the test instrument: 800 kΩ
- <sup>8</sup> for f<sub>N</sub> < 45 Hz => U<sub>N</sub> < 253 V

**Key:** D = digits, rdg. = measured value (reading)

# PROFITEST MTECH+, MPRO, MXTRA, SECULIFE IP

## DIN VDE 0100/IEC 60364-6 Testers

### Characteristic Values PROFITEST MPRO, MXTRA & SECULIFE IP

Function	Measured Quantity	Display Range	Resolution	Input Impedance / Test Current	Measuring Range	Nominal Values	Measuring Uncertainty	Intrinsic Uncertainty	Connections					
									Plug Insert 1	2-Pole Adapter	3-Pole Adapter	Probe	WZ12C	Clamp Z3512A
U	U <sub>L-PE</sub> U <sub>N-PE</sub>	0 ... 99.9 V 100 ... 600 V	0.1 V 1 V	5 MΩ	0.3 ... 600 V <sup>1</sup>	U <sub>N</sub> = 120 V 230 V 400 V 500 V  f <sub>N</sub> = 16 <sup>2</sup> /3 <sup>8</sup> /50/ 60/200/400 Hz	±(2% rdg.+5d) ±(2% rdg. + 1 d)	±(1% rdg.+5d) ±(1% rdg. + 1 d)	●	●	●			
	f	15.0 ... 99.9 Hz 100 ... 999 Hz	0.1 Hz 1 Hz		DC 15.4 ... 420 Hz		±(0.2% rdg. + 1 d)	±(0.1% rdg. + 1 d)						
	U <sub>3~</sub>	0 ... 99.9 V 100 ... 600 V	0.1 V 1 V		0.3 ... 600 V		±(3% rdg.+5d) ±(3% rdg. + 1 d)	±(2% rdg.+5d) ±(2% rdg. + 1 d)		●				
	U <sub>Probe</sub>	0 ... 99.9 V 100 ... 600 V	0.1 V 1 V		1.0 ... 600 V		±(2% rdg.+5d) ±(2% rdg. + 1 d)	±(1% rdg.+5d) ±(1% rdg.+1d)		●				
	U <sub>L-N</sub>	0 ... 99.9 V 100 ... 600 V	0.1 V 1 V		1.0 ... 600 V <sup>1</sup>		±(3% rdg.+5d) ±(3% rdg. + 1 d)	±(2% rdg.+5d) ±(2% rdg. + 1 d)	●		●			
I <sub>ΔN</sub>	U <sub>LΔN</sub>	0 ... 70.0 V	0.1 V	0.3 · I <sub>ΔN</sub>	5 ... 70 V	U <sub>N</sub> = 120 V 230 V 400 V	+10% rdg. + 1 d	+1% rdg. -1d +9% rdg. + 1 d	●	●				
	R <sub>E</sub>	10 Ω ... 999 Ω 1.00 kΩ ... 6.51 kΩ	1 Ω 0.01 kΩ	I <sub>ΔN</sub> = 10 mA · 1.05	calculated value Off R <sub>E</sub> = U <sub>LΔN</sub> / I <sub>ΔN</sub>	f <sub>N</sub> = 50/60 Hz  U <sub>L</sub> = 25/50 V	±(5% rdg. + 1 d)	±(3.5% rdg. + 2 d)	●	●	●	Option		
		3 Ω ... 999 Ω 1 kΩ ... 2.17 kΩ	1 Ω 0.01 kΩ	I <sub>ΔN</sub> = 30 mA · 1.05										
		1 Ω ... 651 Ω	1 Ω	I <sub>ΔN</sub> = 100 mA · 1.05										
		0.3 Ω ... 99.9 Ω 100 Ω ... 217 Ω	0.1 Ω 1 Ω	I <sub>ΔN</sub> = 300 mA · 1.05										
		0.2 Ω ... 9.9 Ω 10 Ω ... 130 Ω	0.1 Ω 1 Ω	I <sub>ΔN</sub> = 500 mA · 1.05										
	I <sub>F</sub> (I <sub>ΔN</sub> = 6 mA)	1.8 ... 7.8 mA	0,1 mA	1.8 ... 7.8 mA	1.8 ... 7.8 mA	10 mA								
	I <sub>F</sub> (I <sub>ΔN</sub> = 10 mA)	3.0 ... 13.0 mA		3.0 ... 13.0 mA	3.0 ... 13.0 mA	30 mA								
	I <sub>F</sub> (I <sub>ΔN</sub> = 30 mA)	9.0 ... 39.0 mA		9.0 ... 39.0 mA	9.0 ... 39.0 mA	100 mA								
	I <sub>F</sub> (I <sub>ΔN</sub> = 100 mA)	30 ... 130 mA	1 mA	30 ... 130 mA	30 ... 130 mA	300 mA								
I <sub>F</sub> (I <sub>ΔN</sub> = 300 mA)	90 ... 390 mA	1 mA	90 ... 390 mA	90 ... 390 mA	500 mA <sup>2</sup>									
I <sub>F</sub> (I <sub>ΔN</sub> = 500 mA)	150 ... 650 mA	1 mA	150 ... 650 mA	150 ... 650 mA										
U <sub>IA</sub> / U <sub>I</sub> = 25 V	0 ... 25.0 V	0.1 V	Same as I <sub>Δ</sub>	0 ... 25.0 V	U <sub>N</sub> ≤ 230 V	+10% rdg. + 1 d	+1% rdg. -1d +9% rdg.+ 1d							
U <sub>IA</sub> / U <sub>I</sub> = 50 V	0 ... 50.0 V			0 ... 50.0 V										
t <sub>A</sub> (I <sub>ΔN</sub> · 1)	0 ... 1000 ms	1 ms	6 ... 500 mA	0 ... 1000 ms										
t <sub>A</sub> (I <sub>ΔN</sub> · 2)	0 ... 1000 ms	1 ms	2 · 6 ... 2 · 500 mA	0 ... 1000 ms	U <sub>N</sub> ≤ 230 V	±4 ms	±3 ms							
t <sub>A</sub> (I <sub>ΔN</sub> · 5)	0 ... 40 ms	1 ms	5 · 6 ... 5 · 300 mA	0 ... 40 ms										
Z <sub>L-PE</sub> Z <sub>L-N</sub>	Z <sub>L-PE</sub> Z <sub>L-N</sub>	0 ... 999 mΩ 1.00 ... 9.99 Ω	1 mΩ 0.01 Ω	3.7 ... 4.7 A AC	0.10 ... 0.49 Ω 0.50 ... 0.99 Ω 1.00 ... 9.99 Ω	U <sub>N</sub> = 120/230 V 400/500 V <sup>1</sup> f <sub>N</sub> = 16 <sup>2</sup> /3 <sup>8</sup> /50/60 Hz	±(10% rdg.+20d) ±(10% rdg.+20d) ±(5% rdg.+3d)	±(5% rdg.+20d) ±(4% rdg.+20d) ±(3% rdg.+3d)	●	●				
	Z <sub>L-PE</sub> + DC	0 ... 999 mΩ 1.00 ... 9.99 Ω 10.0 ... 29.9 Ω	0.1 Ω	3.7 ... 4.7 A AC 0.5/1.25 A DC	0.25 ... 0.99 Ω 1.00 ... 9.99 Ω	U <sub>N</sub> = 120/230 V f <sub>N</sub> = 50/60 Hz	±(18% rdg.+30d) ±(10% rdg.+3d)	±(6% rdg.+50d) ±(4% rdg.+3d)	●	●	Z <sub>L-PE</sub>			
	I <sub>k</sub> (Z <sub>L-PE</sub> )	0 ... 9.9 A 10 ... 99.9 A	0.1 A 1 A		120 (108 ... 132) V 230 (196 ... 253) V 400 (340 ... 440) V 500 (450 ... 550) V									
	Z <sub>L-PE</sub> (with DC)	1.00 ... 9.99 kA 10.0 ... 50.0 kA	10 A 100 A											
	Z <sub>L-PE</sub> (15 mA)	0.5 ... 99.9 Ω 100 ... 999 Ω	0.1 Ω 1 Ω		10 ... 100 Ω 100 ... 1000 Ω	U <sub>N</sub> = 120/230 V f <sub>N</sub> = 16 <sup>2</sup> /3 <sup>8</sup> /50/ 60 Hz	±(10% rdg.+10d) ±(8% rdg. + 2 d)	±(2% rdg. + 2 d) ±(1% rdg. + 1 d)						
I <sub>k</sub> (15 mA)	0.10 ... 9.99 A 10.0 ... 99.9 A 100 ... 999 A <sup>14)</sup>	0.01 A 0.1 A 1 A	15 mA AC	100 mA ... 12 A (U <sub>N</sub> = 120 V) 200 mA ... 25 A (U <sub>N</sub> = 230 V)										
R <sub>E</sub>	R <sub>E,sl</sub> (without probe)	0 ... 999 mΩ 1.00 ... 9.99 Ω 10.0 ... 99.9 Ω	1 mΩ 0.01 Ω 0.1 Ω	3.7 ... 4.7 A AC 3.7 ... 4.7 A AC 400 mA AC	0.10 Ω ... 0.49 Ω 0.50 Ω ... 0.99 Ω 1.0 Ω ... 9.99 Ω	U <sub>N</sub> same as U function 1 f <sub>N</sub> = 50/60 Hz	±(10% rdg.+20d) ±(10% rdg.+20d) ±(5% rdg.+3d)	±(5% rdg.+20d) ±(4% rdg.+20d) ±(3% rdg.+3d)	●	●				
	R <sub>E</sub> (with probe)	100 ... 999 Ω 1 kΩ ... 9.99 kΩ	1 Ω 0.01 kΩ	40 mA AC 4 mA AC	100 Ω ... 999 Ω 1 kΩ ... 9.99 kΩ		±(10% rdg.+3d) ±(10% rdg.+3d)	±(3% rdg.+3d) ±(3% rdg.+3d)						
	R <sub>E</sub> (15 mA) (without/with probe)	0.5 ... 99.9 Ω 100 ... 999 Ω	0.1 Ω 1 Ω	15 mA AC	10 Ω ... 99.9 Ω 100 Ω ... 999 Ω	U <sub>N</sub> = 120/230 V f <sub>N</sub> = 50/60 Hz	±(10% rdg.+10d) ±(8% rdg. + 2 d)	±(2% rdg. + 2 d) ±(1% rdg. + 1 d)	●	●				
	R <sub>E,sl</sub> (without probe) + DC	0 ... 999 mΩ 1.00 ... 9.99 Ω 10.0 ... 29.9 Ω	1 mΩ 0.01 Ω 0.1 Ω	3.7 ... 4.7 A AC 0.5/1.25 A DC	0.25 ... 0.99 Ω 1.00 ... 9.99 Ω	U <sub>N</sub> = 120/230 V f <sub>N</sub> = 50/60 Hz	±(18% rdg.+30d) ±(10% rdg.+3d)	±(6% rdg.+50d) ±(4% rdg.+3d)						
	R <sub>E,sl</sub> (with probe) + DC	10.0 ... 99.9 Ω	0.1 Ω											
U <sub>E</sub>	0 ... 253 V	1 V	3.7 ... 4.7 A AC	R <sub>E</sub> = 0.10 ... 9.99 Ω	U <sub>N</sub> = 120/230 V f <sub>N</sub> = 50/60 Hz	Calculated U <sub>E</sub> = U <sub>N</sub> · R <sub>E</sub> /R <sub>E,sl</sub>								
R <sub>E</sub> Sel Clamp	R <sub>E,sel</sub> (only with probe)	0 ... 999 mΩ 1.00 ... 9.99 Ω 10.0 ... 99.9 Ω 100 ... 999 Ω	1 mΩ 0.01 Ω 0.1 Ω 1 Ω	2.1 A AC 2.1 A AC 400 mA AC 40 mA AC	0.25 ... 300 Ω <sup>4</sup>	U <sub>N</sub> = 120/230 V f <sub>N</sub> = 50/60 Hz	±(20% rdg.+20 d)	±(15% rdg.+20 d)				●		
	R <sub>E,sel</sub> + DC (only with probe)	0 ... 999 mΩ 1.00 ... 9.99 Ω 10.0 ... 99.9 Ω 100 ... 999 Ω	1 mΩ 0.01 Ω 0.1 Ω 1 Ω	3.7 ... 4.7 A AC 0.5/1.25 A DC	0.25 ... 300 Ω R <sub>E,tot</sub> < 10 Ω <sup>4</sup>	U <sub>N</sub> = 120/230 V f <sub>N</sub> = 50/60 Hz	±(22% rdg.+20 d)	±(15% rdg.+20 d)				●		
EXTRA	Z <sub>ST</sub>	10 kΩ ... 199 kΩ 200 kΩ ... 999 kΩ 1.00 MΩ ... 9.99 MΩ 10.0 MΩ ... 30.0 MΩ	1 kΩ 1 kΩ 0.01 MΩ 0.1 MΩ	2.3 mA bei 230 V	10 kΩ ... 199 kΩ 200 kΩ ... 999 kΩ 1.00 MΩ ... 9.99 MΩ 10.0 MΩ ... 30.0 MΩ	U <sub>0</sub> = U <sub>L-N</sub>	±(20% v.M.+2D) ±(10% v.M.+2D)	±(10% v.M.+3D) ±(5% v.M.+3D)	●	●	●	●		
EXTRA	IMD test	20 ... 648 kΩ 2.51 MΩ	1 kΩ 0.01 MΩ	IT line voltage U.it = 90 ... 550 V	20 kΩ ... 199 kΩ 200 kΩ ... 648 kΩ 2.51 MΩ	IT system nominal voltages UN.it = 120/230/400/500 V f <sub>N</sub> = 50/60 Hz	±7% ±12% ±3%	±5% ±10% ±2%	●		●			

# PROFITEST MTECH+, MPRO, MXTRA, SECULIFE IP DIN VDE 0100/IEC 60364-6 Testers

Function	Measured Quantity	Display Range	Resolution	Test Current	Measuring Range	Nominal Values	Measuring Uncertainty	Intrinsic Uncertainty	Connections												
									Plug Insert	2-Pole Adapter	3-Pole Adapter	WZ12C	Clamp Z3512A	MFLEX P300	CP1100						
R <sub>ISO</sub>	R <sub>ISO</sub> , R <sub>E ISO</sub>	1 ... 999 kΩ 1.00 ... 9.99 MΩ 10.0 ... 49.9 MΩ	1 kΩ 10 kΩ 100 kΩ	I <sub>k</sub> = 1.5 mA	50 ... 999 kΩ 1.00 ... 49.9 MΩ	U <sub>N</sub> = 50 V I <sub>N</sub> = 1 mA	kΩ range ±(5% rdg.+10D)  MΩ range ±(5% rdg. + 1 d)	kΩ range ±(3% rdg.+10d)  MΩ range ±(3% rdg. + 1 d)	●	●											
		1 ... 999 kΩ 1.00 ... 9.99 MΩ 10.0 ... 99.9 MΩ	1 kΩ 10 kΩ 100 kΩ		50 ... 999 kΩ 1.00 ... 99.9 MΩ	U <sub>N</sub> = 100 V I <sub>N</sub> = 1 mA															
		1 ... 999 kΩ 1.00 ... 9.99 MΩ 10.0 ... 99.9 MΩ 100 ... 200 MΩ	1 kΩ 10 kΩ 100 kΩ 1 MΩ		50 ... 999 kΩ 1.00 ... 200 MΩ	U <sub>N</sub> = 250 V I <sub>N</sub> = 1 mA															
		1 ... 999 kΩ 1.00 ... 9.99 MΩ 10.0 ... 99.9 MΩ 100 ... 500 MΩ	1 kΩ 10 kΩ 100 kΩ 1 MΩ		50 ... 999 kΩ 1.00 ... 499 MΩ	U <sub>N</sub> = 325 V U <sub>N</sub> = 500 V U <sub>N</sub> = 1000 V I <sub>N</sub> = 1 mA															
	U	10 ... 999 V 1.00 ... 1.19 kV	1 V 10 V	10 ... 1.19 kV		±(3% rdg. + 1 d)	±(1.5% rdg. + 1 d)														
R <sub>LO</sub>	R <sub>LO</sub>	0.00 Ω ... 9.99 Ω 10.0 Ω ... 199.9 Ω	10 mΩ 100 mΩ	I <sub>m</sub> ≥ 200 mA I <sub>m</sub> < 200 mA	0.1 Ω ... 5.99 Ω 6.0 Ω ... 100 Ω	U <sub>0</sub> = 4.5 V	±(4% rdg. + 2 d)	±(2% rdg. + 2 d)	●												
				Transformation ratio <sup>3</sup>			5	5													
SENSOR 6 7	I <sub>L/Amp</sub>	0.0 ... 99.9 mA 100 ... 999 mA 1.00 ... 9.99 A 10.0 ... 15.0 A	0.1 mA 1 mA 0.01 A 0.1 A	1 V/A	5 ... 15 A	f <sub>N</sub> = 50/60 Hz	±(13% rdg.+5d) ±(13% rdg.+1d)	±(5% rdg.+4d) ±(5% rdg.+1d)													
		1.00 ... 9.99 A 10.0 ... 99.9 A 100 ... 150 A	0.1 A 0.1 A 1 A														1 mV/A	5 ... 150 A	±(11% rdg.+4d) ±(11% rdg.+1d)	±(4% rdg.+3d) ±(4% rdg.+1d)	I 15A  II 150A
		0.0 ... 99.9 mA 100 ... 999 mA	0.1 mA 1 mA																		
		0.00 ... 9.99 A 10.0 ... 99.9 A	0.01 A 0.1 A	10 mV/A	0.5 ... 100 A	f <sub>N</sub> = 16.7/50/60/200/400 Hz	±(3.4% rdg.+2 d) ±(3.1% rdg.+2 d) ±(3.1% rdg.+1 d) ±(3.1% rdg.+1 d)	±(3% rdg.+2 d) ±(3% rdg.+1 d) ±(3% rdg.+1 d) ±(3% rdg.+1 d)													
		0.00 ... 9.99 A 10.0 ... 99.9 A	0.01 A 0.1 A						1 mV/A	5 ... 1000 A	±(3.1% rdg.+1 d) ±(3.1% rdg.+2 d) ±(3.1% rdg.+1 d)	±(3% rdg.+1 d) ±(3% rdg.+2 d) ±(3% rdg.+1 d)									
		0.0 ... 99.9 mA 100 ... 999 mA	0.1 mA 1 mA										1 V/A	30 ... 1000 mA	±(27% rdg.+100 d) ±(27% rdg.+11 d)	±(3% rdg.+100 d) ±(3% rdg.+11 d)	0.03 3 0.3 3 300				
		0.00 ... 9.99 A 10.0 ... 99.9 A	0.01 A 0.1 A	100 mV/A	0.3 ... 10 A	f <sub>N</sub> = 50/60 Hz	±(27% rdg.+12 d) ±(27% rdg.+11 d)	±(3% rdg.+12 d) ±(3% rdg.+11 d)													
		0.00 ... 9.99 A 10.0 ... 99.9 A	0.01 A 0.1 A						10 mV/A	3 ... 100 A	±(27% rdg.+100 d) ±(27% rdg.+11 d)	±(3% rdg.+100 d) ±(3% rdg.+11 d)									
		0.00 ... 9.99 A 10.0 ... 99.9 A	0.01 A 0.1 A										10 mV/A	0.5 ... 100 A	f <sub>N</sub> = DC/16.7/50/60/200 Hz	±(5% rdg.+12 d) ±(5% rdg.+2 d)	±(3% rdg.+12 d) ±(3% rdg.+2 d)	100A ~ 1000A ~			
		0.00 ... 9.99 A 10.0 ... 99.9 A	0.01 A 0.1 A	1 mV/A	5 ... 1000 A	±(5% rdg.+50 d) ±(5% rdg.+7 d)	±(3% rdg.+50 d) ±(3% rdg.+7 d)														
		0.00 ... 9.99 A 10.0 ... 99.9 A	0.01 A 0.1 A					1 mV/A	5 ... 1000 A	±(5% rdg.+2 d) ±(5% rdg.+2 d)	±(3% rdg.+2 d) ±(3% rdg.+2 d)										

1 U > 230 V with 2 or 3-pole adapter only  
 2 1 · / 2 · ΔIN > 300 mA and 5 · ΔIN > 500 mA and If > 300 mA only up to U<sub>N</sub> ≤ 230 V !  
 3 The transformation ratio selected at the clamp (1 ... 1000 mV/A) must be set in the "Type" menu with the rotary switch in the "SENSOR" position.  
 4 Where R<sub>Eselective</sub>/R<sub>Etotal</sub> < 100  
 5 the indicated measuring and intrinsic uncertainties already include the uncertainties of the respective current clamp.  
 6 Measuring range of the signal input at the test instrument U<sub>E</sub>: 0 ... 1.0 V<sub>eff</sub> (0 ... 1.4 V<sub>peak</sub>) AC/DC  
 7 Input impedance of signal input at the test instrument: 800 kΩ  
 8 for f<sub>N</sub> < 45 Hz => U<sub>N</sub> < 253 V

## Special Function PROFITEST MPRO, MXTRA

Function	Measured Quantity	Display Range	Resolution	Test Current/ Signal Frequency <sup>5</sup>	Measuring Range	Measuring Uncertainty	Intrinsic Uncertainty	Connections		
								Adapter for Test Plug PRO-RE	PRO-RE/2	Current Clamps Z3512A Z591B
RE BAT	RE, 3-pole	0.00 ... 9.99 Ω 10.0 ... 99.9 Ω 100 ... 999 Ω	0.01 Ω 0.1 Ω 1 Ω	16 mA/128 Hz 1.6 mA/128 Hz 0.16 mA/128 Hz	1.00 Ω ... 19.9 Ω 5.0 Ω ... 199 Ω 50 Ω ... 1.99 kΩ	±(10% rdg.+10D) + 1 Ω	±(3% rdg.+5D) + 0.5 Ω	6		
	RE, 4-pole	1.00 ... 9.99 kΩ 10.0 ... 50.0 kΩ	0.01 kΩ 0.1 kΩ	0.16 mA/128 Hz 0.16 mA/128 Hz	0.50kΩ ... 19.9kΩ 0.50kΩ ... 49.9kΩ	±(10% rdg.+10d)	±(3% rdg.+5d)			
	RE, 4-pole Selective With clamp meter	0.00 ... 9.99 Ω 10.0 ... 99.9 Ω 100 ... 999 Ω 1.00 ... 9.99 kΩ 10.0 ... 19.9 kΩ <sup>15</sup> 10.0 ... 49.9 kΩ <sup>16</sup>	0.01 Ω 0.1 Ω 1 Ω 0.01 kΩ 0.1 kΩ	16 mA/128 Hz 1.6 mA/128 Hz 0.16 mA/128 Hz 0.16 mA/128 Hz	1.00 Ω ... 9.99 Ω 10.0 Ω ... 200 Ω	±(15% rdg.+10d) ±(20% rdg.+10d) <sup>10</sup>	±(10% rdg.+10d) ±(15% rdg.+10d)	6	9	
	Soil resistivity (ρ)	0.0 ... 9.9 Ωm 100 ... 999 Ωm 1.00 ... 9.99 kΩm	0.1 Ωm 1 Ωm 0.01 kΩm	16 mA/128 Hz 1.6 mA/128 Hz 0.16 mA/128 Hz	100 Ωm ... 9.99 kΩm <sup>12</sup> 500 Ωm ... 9.99 kΩm <sup>12</sup> 5.00 kΩm ... 9.99 kΩm <sup>13</sup> 5.00 kΩm ... 9.99 kΩm <sup>13</sup> 5.00 kΩm ... 9.99 kΩm <sup>13</sup>	±(20% rdg.+10d) <sup>11</sup>	±(12% rdg.+10d) <sup>11</sup>	6		
	Probe distance d (p)	0.1 ... 999 m								
	RE, 2 clamps	0.00 ... 9.99 Ω 10.0 ... 99.9 Ω 100 ... 999 Ω 1.00 ... 1.99 kΩ	0.01 Ω 0.1 Ω 1 Ω 0.01 kΩ	30 V / 128 Hz	0.10 ... 9.99 Ω 10.0 ... 99.9 Ω	±(10% rdg.+5d) ±(20% rdg.+5d)	±(5% rdg.+5d) ±(12% rdg.+5d)	7	9	8

5 Signal frequency without interference signal  
 6 PRO-RE (Z501S) adapter cable for test plug, for connecting earth probes (E-Set 3/4)  
 7 PRO-RE/2 (Z502T) adapter cable for test plug, for connecting the generator clamp (E-CLIP2)  
 8 Generator clamp: E-CLIP2 (Z591B) <sup>9</sup> Clamp meter: Z3512A (Z225A)  
 10 Where RE.H/RE ≤ 100 and RE.E/RE ≤ 100  
 11 Where d = 20 m <sup>12</sup> Where d = 2 m  
 12 Where Z<sub>L-PE</sub> < 0.5 Ω, I<sub>k</sub> > U<sub>N</sub>/0.5 Ω is indicated  
 13 Only where RANGE = 20 kΩ  
 14 Only where RANGE = 50 kΩ or AUTO  
 15 Only where RANGE = 20 kΩ  
 16 Only where RANGE = 50 kΩ or AUTO

# PROFITEST MTECH+, MPRO, MXTRA, SECULIFE IP

## DIN VDE 0100/IEC 60364-6 Testers

### PROFITEST MASTER Characteristic Values

#### Reference Conditions

Line voltage	230 V ± 0.1 %
Line frequency	50 Hz ± 0.1 %
Meas. quantity frequency	45 Hz ... 65 Hz
Measured qty. waveform	Sine (deviation between effective and rectified value ≤ 0.1 %)
Line impedance angle	cos φ = 1
Probe resistance	≤ 10 Ω
Supply power	12 V ± 0.5 V
Ambient temperature	+ 23° C ± 2 K
Relative humidity	40% to 60%
Finger contact	For testing potential difference to ground potential
Standing surface insulation	Purely ohmic

#### Power Supply

Rechargeable batteries	8 each AA 1.5 V, we recommend only using the battery pack included in the standard equipment (pack of rechargeable batteries article no. Z502H)
Number of measurements (standard setup with illumination)	
– For R <sub>ISO</sub>	1 measurement – 25 s pause: Approx. 1100 measurements
– For R <sub>LO</sub>	Automatic polarity reversal / 1 Ω (1 measuring cycle) – 25 s pause: Approx. 1000 measurements
Battery test	Symbolic display of battery voltage 
Battery saver circuit	Display illumination can be switched off. The test instrument is switched off automatically after the last key operation. The user can select the desired on-time.
Safety shutdown	If supply voltage is too low, the instrument is switched off, or cannot be switched on.
Recharging socket	Installed rechargeable batteries can be recharged directly by connecting a charger to the recharging socket: charger Z502R
Charging time	Charger Z502R: Approx. 2 hours *

\* Maximum charging time with fully depleted rechargeable batteries.  
A timer in the charger limits charging time to no more than 4 hours.

#### Overload Capacity

R <sub>ISO</sub>	1200 V continuous
U <sub>L-PE</sub> , U <sub>L-N</sub>	600 V continuous
RCD, R <sub>E</sub> , R <sub>F</sub>	440 V continuous
Z <sub>L-PE</sub> , Z <sub>L-N</sub>	550 V (Limits the number of measurements and pause duration. If overload occurs, the instrument is switched off by means of a thermostatic switch.)

R <sub>LO</sub>	Electronic protection prevents switching on if interference voltage is present
Fine-wire fuse protection	FF 3.15 A 10 s, fuses blow at > 5 A

#### Electrical Safety

Protection class	II per IEC 61010-1/EN 61010-1/ VDE 0411-1
Nominal voltage	230/400 V (300/500 V)
Test voltage	3.7 kV 50 Hz
Measuring category	CAT III 500 V or CAT IV 300 V
Pollution degree	2
Fusing, L and N terminals	1 cartridge fuse-link ea. FF 3.15/500G 6.3 x 32 mm

#### Electromagnetic Compatibility (EMC)

Product standard EN 61326-1:2013

Interference emission		Class
EN 55022		A
Interference immunity	Test Value	Feature
EN 61000-4-2	Contact/atmos. – 4 kV/8 kV	
EN 61000-4-3	10 V/m	
EN 61000-4-4	Mains connection – 2 kV	
EN 61000-4-5	Mains connection – 1 kV	
EN 61000-4-6	Mains connection – 3 V	
EN 61000-4-11	0.5 period / 100%	

#### Ambient Conditions

Accuracy	0 to + 40 °C
Operation	–5 to + 50 °C
Storage	–20 to +60 °C (without rechargeable batteries)
Relative humidity	Max. 75%, no condensation allowed
Elevation	Max. 2000 m

#### Mechanical Design

Display	Multiple display with dot matrix, 128 x 128 pixels
Dimensions	W x L x D: 260 x 330 x 90 mm
Weight	approx. 2.7 kg with rechargeable batteries
Protection	Housing: IP 40, test probe: IP 40 per EN 60529/DIN VDE 0470, part 1

#### Data Interfaces

Type	USB slave for PC connection
Type	RS 232 for barcode and RFID scanners
Type	Bluetooth® for connection to PC (PROFITEST MTECH+/MXTRA/SECULIFE IP only)



# PROFITEST MTECH+, MPRO, MXTRA, SECULIFE IP DIN VDE 0100/IEC 60364-6 Testers

## Scope of delivery:

- 1 Test instrument
- 1 Earthing contact plug insert (country-specific)
- 1 2-pole measuring adapter and 1 cable for expansion into a 3-pole adapter (PRO-A3-II)
- 2 Alligator clips
- 1 Shoulder strap
- 1 Set of rechargeable batteries (Z502H)
- 1 Battery charger Z502R
- 1 USB cable
- 1 DAkkS calibration certificate
- 1 Supplement Safety Information
- 1 Condensed operating instructions\*

\* Detailed operating instructions for download from our website at [www.gossenmetrawatt.com](http://www.gossenmetrawatt.com)

- 1 Card with registration key for software



## Special Functions with PROFITEST MPRO and PROFITEST MXTRA

### (Rechargeable) Battery Powered Earthing Resistance Measurements

#### Earthing Resistance $R_E$

3-wire measuring method, probes and earth electrodes connected via PRO-RE adapter

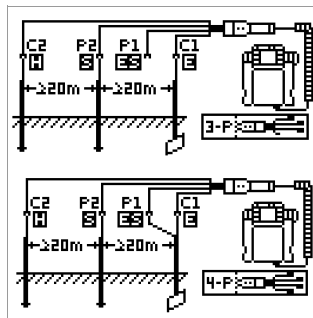

4-wire measuring method, probes and earth electrodes connected via PRO-RE adapter

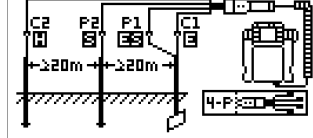

#### Selective Earthing Resistance $R_E$

(4-wire measuring method)  
Current clamp sensor connected directly, probes and earth electrodes connected via PRO-RE adapter

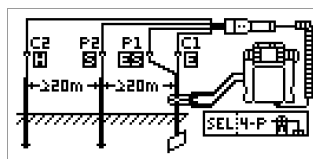

#### Earth Loop Resistance $R_{Eloop}$

2-clamp measurement:  
Current clamp sensor connected directly, current clamp transformer connected via PRO-RE/2 adapter

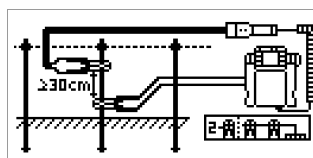

#### Soil Resistivity $\rho_{ho}$

Probes connected via PRO-RE adapter

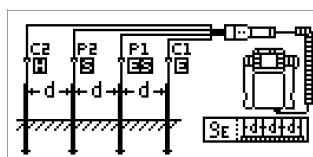

## Special Functions

### with PROFITEST MTECH+/MXTRA and SECULIFE IP

#### Tripping Test for Type B, AC/DC Sensitive RCCDs with Rising DC Residual Current and Measurement of Tripping Current

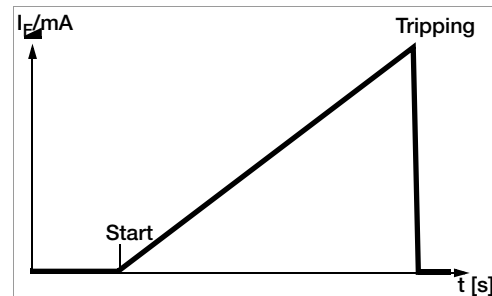

With the selector switch in the  $I_F$  position, slowly rising current flows via N and PE. The momentary measured current value is continuously displayed. When the RCCB is tripped, the last measured current value is displayed. A greatly reduced rate of increase is used for delayed RCCBs (type S).

tripped, the last measured current value is displayed. A greatly reduced rate of increase is used for delayed RCCBs (type S).

#### Tripping Test for Type B, AC/DC Sensitive RCCDs with Constant DC Residual Current and Measurement of Tripping Time

With the selector switch set to the respective nominal residual current, twice the selected nominal current flows via N and PE. Time to trip is measured for the RCCB and displayed.

#### Loop Resistance Measurement with Suppression of RCD Tripping

The test instruments make it possible to measure loop impedance in TN systems with type A, F and type AC RCCBs (10, 30, 100, 300, 500 mA nominal residual current).

The respective test instrument generates a DC residual current to this end, which saturates the RCCB's magnetic circuit. The test instrument then superimposes a measuring current which only demonstrates half-waves of like polarity. The RCCB is no longer capable of detecting this measuring current, and is consequently not tripped during measurement.

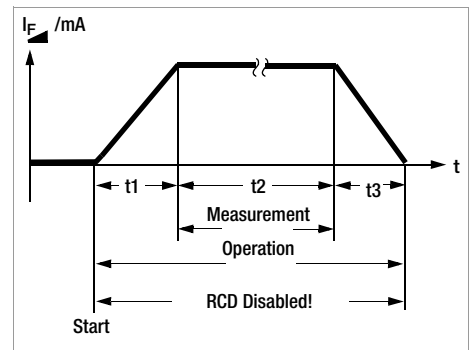

#### Selective Earthing Resistance Measurement (mains powered)

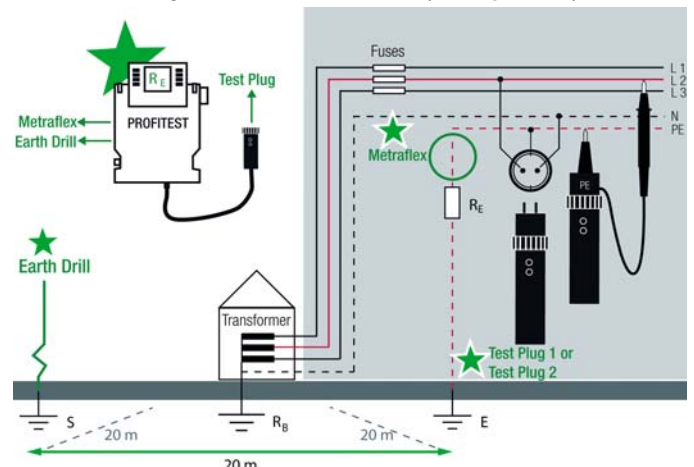

# PROFITEST MTECH+, MPRO, MXTRA, SECULIFE IP

## DIN VDE 0100/IEC 60364-6 Testers

### Special Functions

#### Voltage Drop Measurement (at $Z_{L-N}$ ) – $\Delta U$ Function

According to DIN VDE 100, part 600, voltage drop from the inter-section of the distribution network and the consumer system to the point of connection of an electrical power consumer (electrical outlet or device connector terminals) should not exceed 4% of nominal line voltage.

Voltage drop calculation:

$$\Delta U = Z_{L-N} \cdot \text{rated fuse current}$$

$$\Delta U \text{ as } \% = \Delta U / U_{L-N}$$

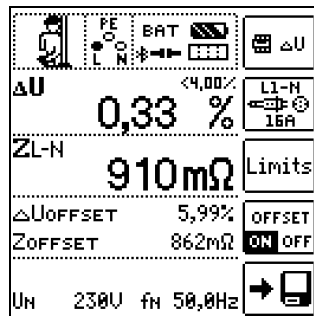
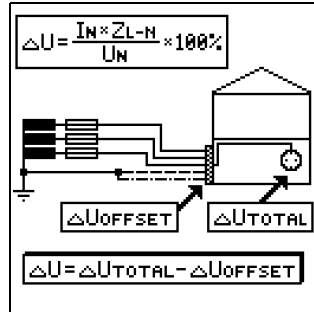

### Special Functions PROFITEST MXTRA

#### Leakage Current Measurement with PRO-AB Adapter (PROFITEST MXTRA only)

Measurement of continuous leakage and patient auxiliary current per IEC 62353 (VDE 0750, part 1) / IEC 601-1 / EN 60 601-1:2006 (Medical electrical equipment – General requirements for basic safety) is possible with the help of the PRO-AB leakage current measuring adapter used as an accessory with the PROFITEST MXTRA test instrument.

As specified in the standards listed above, current values of up to 10 mA may be measured with this measuring adapter.

In order to be able to fully cover this measuring range using the measurement input provided on the test instrument (2-pole current clamp input), the measuring instrument is equipped with range switching between transformation ratios of 10:1 and 1:1.

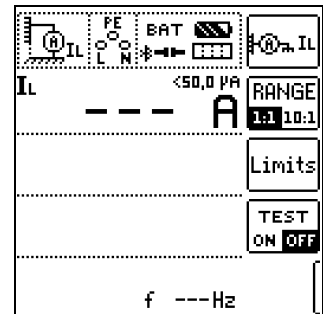
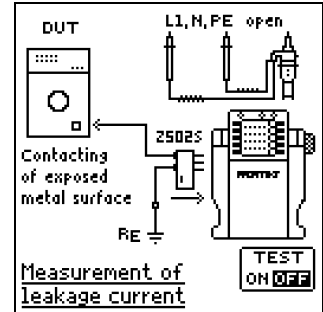

#### Measurement of the Impedance of Insulating Floors and Walls (standing surface insulation impedance) – $Z_{ST}$ Function

The instrument measures the impedance between a weighted metal plate and earth. Line voltage available at the measuring site is used as an alternating voltage source. The  $Z_{ST}$  equivalent circuit is considered a parallel circuit.

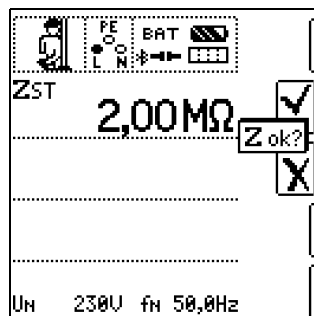
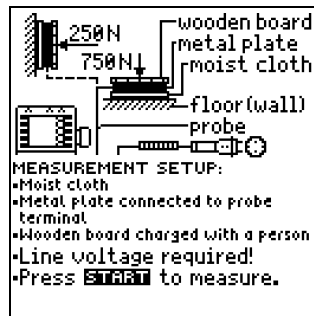

#### Testing of Insulation Monitoring Devices (IMDs) (PROFITEST MXTRA and SECULIFE IP only)

Insulation monitors are used in power supplies for which a single-pole earth fault may not result in failure of the power supply, for example in operating rooms or photovoltaic systems.

Insulation monitors can be tested with the help of this special function. After pressing the start button, an adjustable insulation resistance is activated between one of the two phases of the IT system to be monitored and ground to this end. This resistance can be changed in the manual sequence mode with the help of the softkeys, and it can be varied automatically from  $R_{max}$  to  $R_{min}$  in the automatic operating mode.

Time, during which the momentary resistance value prevails at the system until the next change in value, is displayed. The IMD's display and response characteristics can be subsequently evaluated and documented with the help of the softkeys.

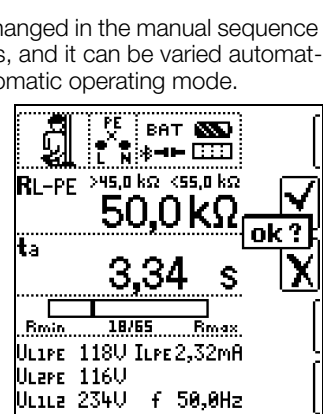
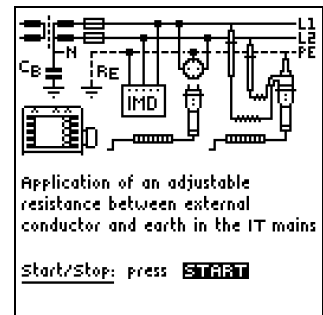

# PROFITEST MTECH+, MPRO, MXTRA, SECULIFE IP DIN VDE 0100/IEC 60364-6 Testers

## Special Functions PROFITEST MXTRA

### Determining Residual Voltage / Detecting Mains Fluctuations (PROFITEST MXTRA only)

The EN 60204 standard specifies that after switching supply power off, residual voltage between L and PE must drop to a value of 60 V or less within 5 seconds at all accessible, active components of a machine to which a voltage of greater than 60 V is applied during operation.

With the PROFITEST MXTRA, testing for the absence of voltage is performed as follows by means of a voltage measurement which involves measuring discharge time  $t_u$ :

In the case of voltage dips of greater than 5% of momentary line voltage (within 0.7 seconds), the stopwatch is started and momentary undervoltage is displayed as  $U_{res}$  after 5 seconds and indicated by the red UL/RL diode.

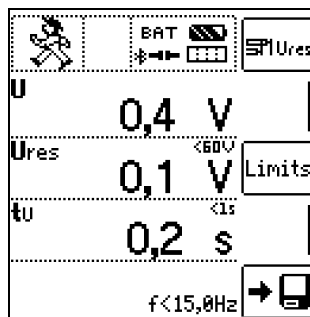
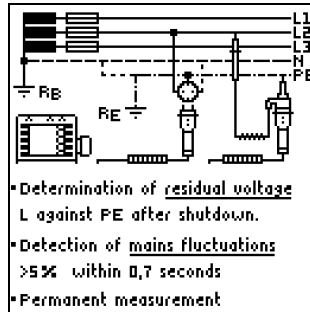

### Intelligent Ramp (PROFITEST MXTRA only)

The advantage of this measuring function in contrast to individual measurement of  $I_{\Delta N}$  and  $t_A$  is the simultaneous measurement of breaking time and breaking current by means of a test current which is increased in steps, during which the RCD is tripped only once.

The intelligent ramp is subdivided into time segments of 300 ms each between the initial current value (35%  $I_{\Delta N}$ ) and the final current value (130%  $I_{\Delta N}$ ). This results in a gradation for which each step corresponds to a constant test current which is applied for no longer than 300 ms, assuming that tripping does not occur.

And thus both tripping current and tripping time are measured and displayed.

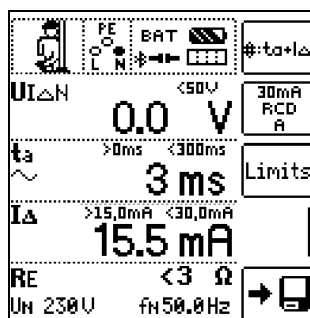
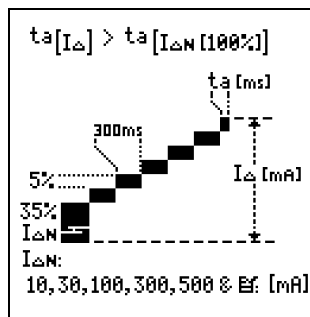

## Special Functions PROFITEST MXTRA

### Testing Residual Current Monitoring Devices (RCMs) (PROFITEST MXTRA only)

RCMs (residual current monitors) monitor residual current in electrical systems and display it continuously. As is also the case with residual current devices, external switching devices can be controlled in order to shut down supply power in the event that a specified residual current value is exceeded. However, the advantage of an RCM is that the user is informed of fault current within the system before shutdown takes place.

As opposed to individual measurement of  $I_{\Delta N}$  and  $t_A$ , measurement results must be evaluated manually in this case.

If an RCM is used in combination with an external switching device, the combination must be tested as if it were an RCD.

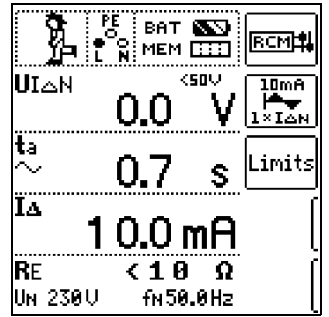
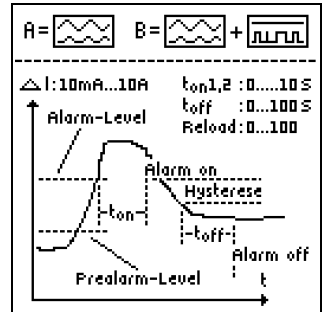

### Testing the Operating States of Electric Vehicles at Charging Stations per IEC 61851 (PROFITEST MTECH+ & PROFITEST MXTRA only)

A charging station is an equipment designed for the charging of electric vehicles per IEC 61851 which essentially consists of a plug connector, a cable protection, a residual current device (RCD), as well as a circuit breaker and a security communication system (PWM).

Depending on the place of installation and application, further functional features such as mains connection and meter may be included.

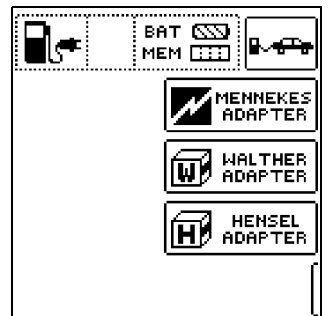

### Simulation of operating states per IEC 61851 with the MENNEKES test box (State A – E)

The MENNEKES test box only serves the purpose of simulating different operating states of an electric vehicle fictitiously connected with a charging station.

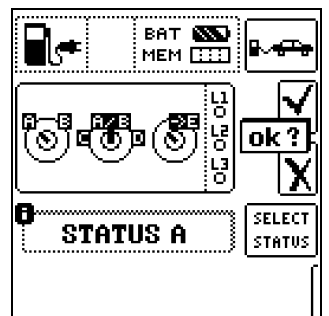

# PROFITEST MTECH+, MPRO, MXTRA, SECULIFE IP

## DIN VDE 0100/IEC 60364-6 Testers

### Special Functions PROFITEST MXTRA

Test Sequences for Report Generation of Fault Simulations on PRCDS type S and K with PROFITEST PRCD (PROFITEST MXTRA only):

- Three test sequences are preconfigured:
  - PRCD-S (single phase/3-pole)
  - PRCD-K (single phase/3-pole)
  - PRCD-S (three-phase/5-pole)
- The test instrument guides you through all test steps in a semi-automatic fashion:
  - Single phase PRCDS: PRCD-S: 11 test steps  
PRCD-K: 4 test steps
  - 3-phase PRCDS: PRCD-S: 18 test steps
- Each test step is assessed and evaluated by the user (OK/not OK) for subsequent report generation purposes.
- Measurement of protective conductor resistance of the PRCD by means of function  $R_{LO}$  at the test instrument.
- Measurement of insulation resistance of the PRCD by means of function  $R_{ISO}$  at the test instrument.
- Trip test with nominal fault current by means of function  $I_F$  at the test instrument.
- Measurement of tripping time by means of function  $I_{\Delta N}$  at the test instrument.
- Varistor test with PRCD-K: measurement via ISO ramp.

Further information is included in the data sheet for the PROFITEST PRCD.



### Selecting the PRCD under Test

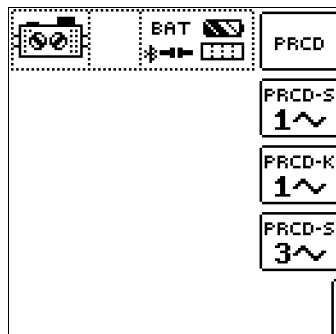

### Example Simulation Interruption

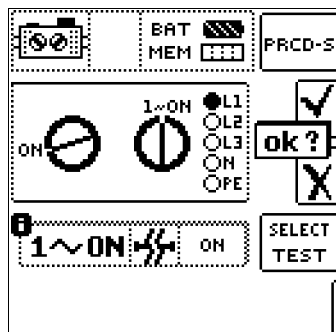

### Special Functions (all Types)

#### Automatic Test Sequence Function

If the same order of tests with subsequent report generation is to be performed repeatedly, as is, for example, specified by certain standards, we recommend using test sequences.

With the help of test sequences it is possible to compile automatic test procedures on the basis of the manual individual measurements. A test sequence consists of up to 200 individual test steps which have to be processed one after the other.

The test sequences are created at a PC by means of the ETC software and are then transferred to the PROFITEST MPRO or PROFITEST MXTRA test instruments.

The measurement parameters are also configured at a PC. However, they can still be modified at the test instrument during the test procedure before the respective measurement is launched.

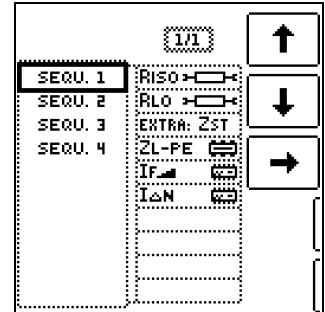

#### Bluetooth® Interface (PROFITEST MTECH+/MXTRA/SECULIFE IP only)

If your PC is equipped with a Bluetooth® interface, wireless communication is possible between the test instrument and ETC user software for the transfer of data and test structures.

Furthermore, it is possible to connect a Bluetooth keyboard (Logitech).

# PROFITEST MTECH+, MPRO, MXTRA, SECULIFE IP DIN VDE 0100/IEC 60364-6 Testers

IZYTRONIQ

Database Software for Complete Management  
and Documentation of Testing

IZYTRON **IQ**  
STARTER BUSINESS

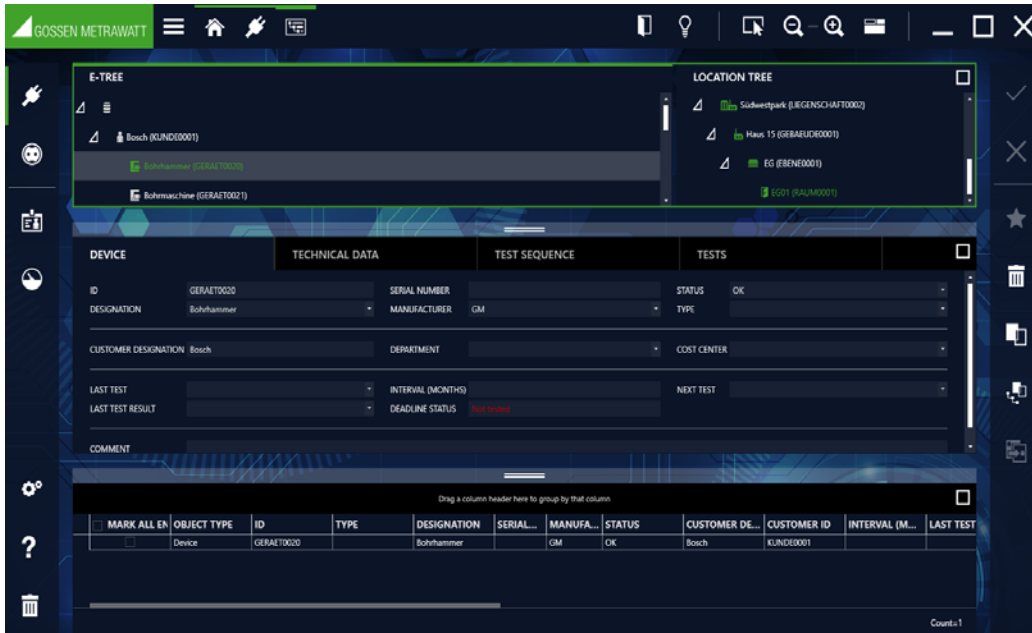

IZYTRONIQ allows for the management and documentation of measured values for the following test instruments of the PROFITEST MASTER series:

PROFITEST MPRO, PROFITEST MTECH+, PROFITEST MXTRA, SECULIFE IP; as from firmware version 3.1.0 in each case.

## Basic Modules

IZYTRONIQ is broken down into modules in a clear-cut fashion:

- **Portable objects (devices and medical devices)** Testing, acquisition and management of portable devices
- **Stationary objects (machines and systems)** Testing, acquisition and management of stationary devices
- **User administration** Enter and manage users
- **Test instrument management** Enter and manage test instruments

*For further information on the application software please refer to the internet at [www.izytron.com](http://www.izytron.com)*

## Report Generation Accessories

*See following page and separate ID systems data sheet regarding barcode scanners and printers, as well as RFID readers.*

## Scope of Functions of the BUSINESS Starter Variant

- Stationary objects (machinery & facilities)
- Portable objects (devices & medical devices)
- Test device management
- User management
- Push/print function
- Sequence management + sequence editor
- Catalog management and editing
- Tree structure for machinery and facilities
- Tree structure for devices and medical devices
- Tree structure for locations (facilities, buildings, levels & rooms)
- Simple universal report as a PDF
- Simple list generator (PDF, Excel)
- Red/green test analysis

## Main communication features

- Import of memory structure, catalogs, sequences and measurements from the test device
- Export of memory structure, catalogs and sequences to the test device
- Data import of memory structure, catalogs, sequences and measurements from an XML file
- Data export of memory structure, catalogs, sequences and measurements to an XML file
- Data import of master data for portable objects from a CSV file

# PROFITEST MTECH+, MPRO, MXTRA, SECULIFE IP DIN VDE 0100/IEC 60364-6 Testers

Barcode scanner for connection to RS 232 port at tester – Z502F



Barcode and label printer for USB connection to a PC – Z721E

Barcode/label printer for connection to a PC, for self-adhesive, smudge-proof barcode labels, for identifying devices and system components. Devices and system components can be logged by our test instruments, and acquired measured values can be allocated to them with the scanner.



SCANBASE RFID reader for connection to RS 232 port at tester – Z751G



The Z751G RFID reader is pre-programmed to scan the following RFD tags.

Order No.	Frequency	Standard	Type	Quantity per Package
Z751R	13.56 MHz	ISO 15693	approx. 22 mm dia., self-adhesive	500 pieces
Z751S	13.56 MHz	ISO 15693	approx. 30 x 2 mm dia. with 3 mm hole	500 pieces
Z751T	13.56 MHz	ISO 15693	Pigeon ring, approx. 10mm dia.	250 pieces

## Power Supply Accessories

Z502H Master Battery Pack

Charger Z502R



with angle plug/  
jack plug

## Accessory Plug Inserts and Adapters

Country specific Plug Inserts  
PRO-Schuko

PRO-W



Country specific Plug Insert  
PRO-GB-USA (Z503B)

Test Probes (L 68 mm, Ø 2,3 mm)  
Set-Probes (Z503F)



Flat test clip for contacting on busbars PRO-PE Clip (Z503G)



Magnetic measuring contacts (patent) with magnetic strain relief (Z502Z)

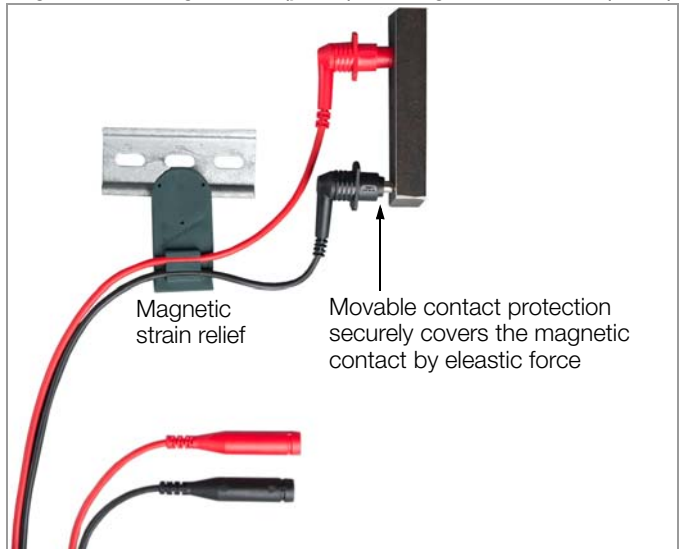

Magnetic  
strain relief

Movable contact protection  
securely covers the magnetic  
contact by elastic force

# PROFITEST MTECH+, MPRO, MXTRA, SECULIFE IP DIN VDE 0100/IEC 60364-6 Testers

## Safety Clip (Z503W)



## PRO-RLO-II Plug Insert



## PRO-UNI-II Plug Insert

## 3-Phase Current Adapters 5-pole



A3-16, A3-32 and A3-63 3-phase adapters are used for trouble-free connection of test instruments to 5-pole CEE outlets. The three variants differ with regard to plug size, which corresponds respectively to 5-pole CEE outlets with current ratings of 16, 32 and 63 A. Phase sequence is indicated with lamps at all three variants. Testing the effectiveness of safety measures is conducted via five 4 mm contact protected sockets.

## 3-Phase Current Adapter 7-pole



A3-16 Shielded and A3-32 Shielded 3-phase adapters are used for trouble-free connection of test instruments to 7-pole CEE outlets. The two variants differ with regard to plug size, which corresponds respectively to 7-pole CEE outlets with current ratings of 16 and 32 A. Testing the effectiveness of safety measures is conducted via seven 4 mm sockets with touch protection.

## Variable Plug Adapter Set



Three self-retaining, contact protected test probes for the connection of measurement cables with 4 mm banana plugs, or with contact protected plugs for sockets with an opening of 3.5 mm to 12 mm, e.g. CEE, Perilex sockets etc. For example, the test probes also fit the square PE jacks on Perilex sockets. Maximum allowable operating voltage: 600 V per IEC 61010.

## PRO-AB Leakage Current Measuring Adapter for PROFITEST MXTRA and SECULIFE IP



Input current:  
0 to 10 mA  
Input impedance:  
1 kΩ ± 0.5%  
Output voltage:  
10:1 0 to 1 V (0.1 V/mA)  
1:1 0 to 10 V (1 V/mA)  
Output impedance: 10 kΩ



## ISO Calibrator 1

Calibration adapter for rapid, efficient testing of the accuracy of measuring instruments for insulation resistance and low-value resistors

## KS24 Cable Set



The KS24 cable set includes a 4 m long extension cable with a permanently attached test probe at one end and a contact protected socket at the other end, as well as an alligator clip which can be plugged onto the test probe.

## TELEARM 120 Telescoping Rod



## Case TELEARM



## Floor Probe



The 1081 floor probe makes it possible to measure the resistance of insulating floors in accordance with DIN VDE 0100, part 600, and EN 1081.

# PROFITEST MTECH+, MPRO, MXTRA, SECULIFE IP DIN VDE 0100/IEC 60364-6 Testers

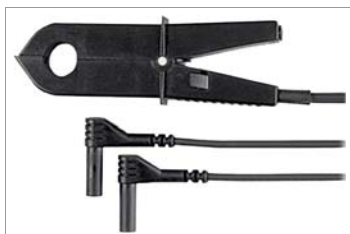

**WZ12C (Z219C)**

Current clamp sensor for leakage current, selectable measuring ranges: 1 mA to 15 A, 3% and 1 A to 150 A, 2%  
Transformation ratios:  
1 mV/mA, 1 mV/A

**E-Clip 2 Clamp Generator (Z591B)**



Measuring range:  
0.2 A to 1200 A  
Measuring category:  
600 V CAT III  
Max. cable dia.: 52 mm  
Transformation ratio:  
1000 A/1A  
Frequency range:  
40 Hz to 5 kHz

**METRAFLEX P300 (Z502E)**

Flexible current clamp sensor for selective earthing resistance measurement  
3/30/300 A, 1 V/100 mV/10 mV/A



Output signal: 0.2 mA to 1.2 A

Equipped with laboratory safety plug inputs



**Z3512A**

AC Current  
Sensor Clamp

Switchable measuring ranges:

1 mA to 1/100/1000 A~

Transformation ratios:

1 V/A, 100mV/A, 10 mV/A, 1 mV/A

## Earthing Resistance Measurement Accessories



**PRO-RE/2 Clamp Adapter (Z502T)**

Adapter which is mounted to the test plug allowing for connection of the E-Clip 2 generator clamp for 2-clamp or ground-loop earthing resistance measurement.

2-clamp or ground loop measurement is thus made possible.



**TR25II Cable reel (Z503X)**

25 m measurement cable coiled onto a plastic drum. Connection to the inside end of the cable is made possible with two sockets integrated into the drum. The other end is equipped with a banana plug. Cable resistance can be compensated for with the rotary selector switch in the  $R_{LO}$  position.

**TR50II Cable reel (Z503Y)**



50 m measurement cable coiled onto a plastic drum. Connection to the inside end of the cable is made possible with two sockets integrated into the drum. The other end is equipped with a banana plug. Cable resistance can be compensated for with the rotary selector switch in the  $R_{LO}$  position.



**PRO-RE Adapter (Z501S)**

Earth electrodes, auxiliary earth electrodes, probe and auxiliary probe are connected to the tester via the banana plug sockets, and thus via the adapter which is mounted to the test plug.

**SP500Earth Drill (Z503Z)**





# PROFITEST MTECH+, MPRO, MXTRA, SECULIFE IP DIN VDE 0100/IEC 60364-6 Testers

E-SET PROFESSIONAL (Z592A)



E-CHECK Case (Z502M)



Outside dimensions:  
H x W x D  
390 x 590 x 230 mm

Sample Contents



## Accessory Cases and Trolleys

SORTIMO L-BOXX GM (Z503D)



Plastic system case  
Outside dimensions:  
W x H x D  
450 x 255 x 355 mm  
Foam insert Z503E  
for tester and acces-  
sories, has to be  
ordered seperately,  
see below.

Foam insert for SORTIMO L-BOXX GM (Z503E)



Profi-Case (Z502W)



Outside dimensions:  
H x W x D  
390 x 590 x 230 mm

F2000 Universal Carrying Pouch (Z700D)



Outside dimensions:  
W x H x D  
380 x 310 x 200 mm  
(without buckles, handle  
and carrying strap)

F2020 Large Universal Carrying Pouch (Z700F)



Outside dimensions:  
W x H x D  
430 x 310 x 300 mm  
(without buckles,  
handle and carrying  
strap)

# PROFITEST MTECH+, MPRO, MXTRA, SECULIFE IP DIN VDE 0100/IEC 60364-6 Testers

## Trolley for Profi-Case (Z502B) and E-CHECK Case (Z502N)

Folded-up dimensions: 395 x 150 x 375 mm



## Ever-ready case for PROFITEST MASTER (Z502X)



## E-Mobility Accessories

### PRO-TYP I (Z525B)



#### Vehicle Simulation (CP)

Vehicle states A through E are selected with a rotary switch.

**Cable Simulation (PP)**  
via permanently wired cable coding

#### Fault Simulation

Simulation of a short-circuit between CP and PE by means of a rotary switch

**Indication of Phase Voltages** via LEDs

### PRO-TYP II (Z525A)



#### Vehicle Simulation (CP)

Vehicle states A through E are selected with a rotary switch.

**Cable Simulation (PP)**  
The various codings for charging cables with 13, 20, 32 and 63 A, as well as "no cable connected", can be simulated with the help of a rotary switch.

#### Fault Simulation

Simulation of a short-circuit between CP and PE by means of a rotary switch

**Indication of Phase Voltages** via LEDs

Depending on the charging station, either one or three phases can be active.

**Testing of electrical charging stations with permanently connected charging cable** due to extended CP test pin

## Order Information

Designation	Type	Article Number
<b>PROFITEST MASTER Instrument Variants</b>		
Universal protective measures test instrument per EN 61557, sections 1, 2, 3, 4, 5, 6, 7 and 10 with integrated memory and insulation measurement up to 1000 V as well as selective earth measurement with current clamps as optional accessories, with <b>DAkKS calibration certificate</b> and <b>IZYTRONIQ BUSINESS Starter</b>	PROFITEST MPRO IQ	M535C

# PROFITEST MTECH+, MPRO, MXTRA, SECULIFE IP DIN VDE 0100/IEC 60364-6 Testers

Designation	Type	Article Number
Universal protective measures test instrument per EN 61557, sections 1, 2, 3, 4, 5, 6, 7 and 10 with integrated memory and insulation measurement up to 1000 V as well as additional tripping test for AC/DC sensitive RCDs and loop impedance measurement without tripping the RCD, e-mobility test, Bluetooth interface, <b>DAKkS calibration certificate</b> and <b>IZYTRONIQ BUSINESS Starter</b>	<b>PROFITEST MTECH+ IQ</b>	M535B
Universal protective measures test instrument per EN 61557, sections 1, 2, 3, 4, 5, 6, 7 and 10 with integrated memory and insulation measurement up to 1000 V as well as additional tripping test for AC/DC sensitive RCDs, loop impedance measurement without tripping the RCD, selective earth measurement with current clamps as optional accessories, testing of IMDs and RCMs, Bluetooth interface, <b>DAKkS calibration certificate</b> and <b>IZYTRONIQ BUSINESS Starter</b>	<b>PROFITEST MXTRA IQ</b>	M535D
Universal protective measures test instrument per EN 61557, sections 1, 2, 3, 4, 5, 6, 7 and 10 with integrated memory and insulation measurement up to 1000 V as well as additional tripping test for AC/DC sensitive RCDs and loop impedance measurement, testing of IMDs, Bluetooth interface, <b>DAKkS calibration certificate</b> and <b>IZYTRONIQ BUSINESS Starter</b>	<b>SECULIFE IP IQ</b>	M535E
<b>Test Instrument Power Supply Accessories</b>		
8 LSD NiMH rechargeable batteries with reduced self-discharging (AA), with sealed cells	MASTER Battery Set	Z502H
Broad-range charger for charging batteries included in the <b>PROFITEST MTECH+</b> , <b>MPRO</b> , <b>MXTRA</b> and <b>SECULIFE IP</b> Input: 100 to 240 V AC Output: 16.5 V DC, 1 A	<b>PROFITEST MASTER Charger</b>	Z502R
<b>Accessory Plug Inserts and Adapters</b>		
Earth contact plug insert (Schuko): D, A, NL, F etc.	PRO-Schuko	GTZ3228000R0001
same as PRO-Schuko, however with angled earth-contact plug	PRO-W	Z503A
Plug insert per SEV: CH	PRO-CH	GTZ3225000R0001
Plug insert with adapters for GB & USA	PRO-GB/USA-Set	Z503B
Plug insert for South Africa	PRO-RSA	Z501A
2/3-pole measuring adapter for 3-phase and rotating-field systems, 300 V/1 A CAT IV with safety cap 600 V/1 A CAT III with safety cap 600 V/16 A CAT II without safety cap	PRO-A3-II	Z5010
same as PRO-A3-II, however with straight cables of 10m each instead of coil cables	PRO-A3-II ncc	Z503C
Set-Probes CAT III / 600 V, 1 A, working range of the probes 68 mm – diameter 2,3 mm	Set-Probes	Z503F
Safety Clip red and blue with hock, 1 kV CAT IV, 20 A	Safety Clip	Z503W

Designation	Type	Article Number
Flat test clip for fast and safe contacting on busbars. Powerful contacting on the front and rear of the busbars by means of established Multilam. Fixed Ø 4 mm socket in the pressure grip handle section, to fit spring-loaded Ø 4 mm plugs with rigid insulating sleeve. 1000 V CAT IV/32 A	PRO-PE Clip	Z503G
2 magnetic measurement contacts with contact protection – Set with magnetic holder, measurement contacts 5,5 mm in diameter insulated, CAT III 1.000 V / 4 A, temperature between –10 °C and 60 °C, under standard conditions and flat-head screws holding force 1.200 g vertical to contact area; measuring instrument connector: 4 mm sockets for PRO-A3-II	Set 3 – Magn. Measuring Tips	Z502Z
With 10 m cable based on 2-wire measuring technology for PE and similar measurements, 300 V / 16 A CAT IV	PRO-RLO-II	Z501P
With 3 connector cables for any connection standards, 300 V / 16 A, CAT IV	PRO-UNI-II	Z501R
5-pole 3-phase adapter for 16 A CEE outlets	A3-16	GTZ3602000R0001
5-pole 3-phase adapter for 32 A CEE outlets	A3-32	GTZ3603000R0001
5-pole 3-phase adapter for 63 A CEE outlets	A3-63	GTZ3604000R0001
Three-phase adapter shielded, 7-pin for CEE socket outlets 16 A, CAT III 300 V – 10 A	A3-16 Shielded	Z513A
Three-phase adapter shielded, 7-pin for CEE socket outlets 32 A, CAT III 300 V – 10 A	A3-32 Shielded	Z513B
Variable Plug Adapter Set	Z500A	Z500A
Calibration adapter for testing of the accuracy of measuring instruments for insulation resistance and low-value resistors	ISO Calibrator 1	M662A
Leakage current measuring adapter for <b>PROFITEST MXTRA</b> and <b>SECULIFE IP</b>	PRO-AB	Z502S
<b>Accessories</b>		
Extension cable, 4 m	KS24	GTZ3201000R0001
Telescoping rod for RLO and RISO measurement, CAT III 600 V / CAT IV 300 V, 1 A, retracted/extended 53,3 cm/120 cm, 190 g	TELEARM 120 <sup>U</sup>	Z505C
Telescoping rod for RLO and RISO measurement, CAT III 600 V / CAT IV 300 V, 1 A, retracted/extended 73,5 cm/180 cm, 250 g	TELEARM 180 <sup>U</sup>	Z505D
Case TELEARM for Telearm 120/180, 920 x 170 mm	Case TELEARM	Z505E
Triangular probe for floor measurements in accordance with EN 1081 and DIN VDE 0100	1081 Probe	GTZ3196000R0001
Current clamp sensor for leakage current, switchable: 1 mA to 15 A, 3% and 1 A to 150 A, 2%	WZ12C <sup>D</sup>	Z219C
Flexible AC current sensor, 3, 30, 300 A, 1 V, 100 mV, 10 mV / A, with batteries, probe length: 45 cm	METRAFLEX P300	Z502E
<b>Accessory Cases and Trolleys</b>		
Ever-ready case with bags for accessories	Ever-ready Case PROFITEST MASTER	Z502X
Aluminum case for test instrument and accessories	E-CHECK Case	Z502M
The E-CHECK case can be mounted to the trolley.	Trolley for E-CHECK Case	Z502N

# PROFITEST MTECH+, MPRO, MXTRA, SECULIFE IP

## DIN VDE 0100/IEC 60364-6 Testers

Designation	Type	Article Number
Universal carrying pouch	F2000 <sup>D</sup>	Z700D
Large universal carrying pouch	F2020	Z700F
Plastic system case	SORTIMO L-BOXX GM	Z503D
Foam insert for SORTIMO L-BOXX GM with divider for PROFITEST MASTER	Foam SORTIMO L-BOXX Profitest M	Z503E
Profi-hardcase with imprint and dividers for sets with Profitest Master and accessories incl. trolleyholder	Profi-Case	Z502W
<b>Earthing Resistance Measurement Accessories</b>		
Measuring adapter for connecting a second clamp (generator clamp), allows for 2-clamp measuring method (ground loop measurement)	PRO-RE-2	Z502T
Connection adapter for earthing accessories for 3/4-wire measurement and selective earthing resistance measurement	PRO-RE	Z501S
Generator clamp for 2-clamp measuring method (ground loop measurement), transformation ratio: 1000 A / 1 A, current measuring range: 0.2 A to 1200 A, output signal: 0.2 mA to 1.2 A	E-CLIP 2	Z591B
Current clamp sensor for selective earth measurement and as clamp meter for 2-clamp measuring method (ground loop measurement), switchable measuring ranges: 0 to 1 / 100 / 1000 A~ AV~ ± (0.7% to 0.2%)	Z3512A <sup>D</sup>	Z225A
Cable reel for low-resistance and earth-resistance measurement, 25 m	TR25II	Z503X
Cable reel for low-resistance and earth-resistance measurement, 50 m	TR50II	Z503Y
Earth Drill 500 mm	SP500	Z503Z
Accessories for earthing measurement consisting of 1 x carrier bag, 4 earth spikes 500 mm, 1 x measuring lead 40 m blue on cable drum with hand strap, 1 x measuring lead 20 m red on cable drum with hand strap, 1 x measuring lead 5 m black, 1 x measuring lead 5 m green, 1 x test clamp with black 4 mm socket, 1 x test clamp with green 4 mm socket, 1 x hammer, 1 x roller tape measure, 1 x duster, 1 x writing pad with pen	E-SET PROFESSIONAL	Z592A
Earth testing set: 1 drum with 25 m measurement cable 2 drums with 50 m measurement cable each, 4 measurement cables, 3 x 0.5 m long, 1 x 2 m long, 1 test clamp, 4 earth drills, each 350 mm long, 1 dust cloth, 2 pads of earth testing measurement data forms	E-Set 5	Z590B
Test adapter for testing portable safety switches (types PRCD-K and PRCD-S) with the help of the PROFITEST MXTRA test instrument (not included)	PROFITEST PRCD <sup>D</sup>	M512R

Designation	Type	Article Number
<b>Starter Packages</b>		
consisting of <b>PROFITEST MTECH+ IQ</b> , Vario-Plug-Set, SORTIMO L-BOXX, Foam SORTIMO L-BOXX, Set-Probes, Battery Pack Master and charger plus <b>IZYTRONIQ BUSINESS ADVANCED</b>	Starter package TECH-plus IQ	M536A
consisting of <b>PROFITEST MTECH+ IQ</b> , Vario-Plug-Set, SP350 Earth Drill, Drum TR50, PRO W, PRO-RLO II, Set-Probes, Profi-Case, Battery Pack Master and charger plus <b>IZYTRONIQ BUSINESS PROFESSIONAL</b>	Master package TECH-plus IQ	M536B
Consisting of <b>PROFITEST MXTRA IQ</b> , VARIO-STECKER-Set, plastic system case SORTIMO L-BOXX GM with foam insert, MASTER Battery Set and MPRO MXTRA Charger, set of test probes plus <b>IZYTRONIQ BUSINESS ADVANCED</b>	XTRA Starter Package IQ	M536C
Consisting of <b>PROFITEST MXTRA IQ</b> , VARIO-STECKER-Set, Profi Case, PRO-W plug insert, PRO-RLO-II, MASTER Battery Set and MPRO MXTRA Charger, set of test probes plus <b>IZYTRONIQ BUSINESS PROFESSIONAL</b>	XTRA Master Package IQ	M536D
Consisting of <b>PROFITEST MXTRA IQ</b> , VARIO-STECKER-Set, Profi Case, leakage current measuring adapter PRO-AB, MASTER Battery Set and MPRO MXTRA Charger, set of test probes plus <b>IZYTRONIQ BUSINESS ADVANCED</b>	XTRA MED Package IQ	M536E
Consisting of <b>PROFITEST MXTRA IQ</b> , VARIO-STECKER-Set, Profi Case, PRO-W plug insert, generator clamp E-Clip 2 and Current clamp sensor for earth measurement Z3512A, measuring adapter for connecting a second clamp PRO-RE-2, MASTER Battery Set and MPRO MXTRA Charger, set of test probes plus <b>IZYTRONIQ BUSINESS PROFESSIONAL</b>	XTRA Profi Package IQ	M536F
<b>E-Mobility Accessories</b>		
Single phase test adapter with type 1 plug	PRO-TYP I <sup>D</sup>	Z525B
Single and 3-phase test adapter with type 2 plug	PRO-TYP II <sup>D</sup>	Z525A
Single and 3-phase test adapter with type 2 plug; Version with swiss type socket	PRO-TYP II-CH	Z525D
<b>Report Generating Accessories</b>		
See separate ID systems data sheet regarding barcode scanners/printers and RFID readers.		
Barcode scanner for RS 232 connection with roughly 1 m coil cable	RS 232 Profiscanner for Barcodes	Z502F
RFID reader/writer	SCANBASE RFID	Z751G

<sup>D</sup> Data sheet available

For additional information regarding accessories please refer to *Measuring Instruments and Testers catalog*

Edited in Germany • Subject to change without notice • PDF version available on the Internet

 **GOSSEN METRAWATT**

GMC-I Messtechnik GmbH  
Südwestpark 15  
90449 Nürnberg • Germany

Phone: +49 911 8602-111  
Fax: +49 911 8602-777  
E-mail: info@gossenmetrawatt.com  
www.gossenmetrawatt.com

## X-ON Electronics

Largest Supplier of Electrical and Electronic Components

*Click to view similar products for [Digital Multimeters](#) category:*

*Click to view products by [Gossen Metrawatt](#) manufacturer:*

Other Similar products are found below :

[6111-517](#) [FS881](#) [40705X](#) [C.A 6133 LAUNCH KIT](#) [P 1020 A](#) [P 3340](#) [SEFRAM7303](#) [BS K-CLIP](#) [19290](#) [IBT6K](#) [1000-219](#) [1001-613](#) [1006-969](#) [1008-221](#) [1012-597](#) [1013-099](#) [30XR](#) [34XR](#) [35XP](#) [TESTO 745](#) [0590 7450](#) [TESTO 760-2](#) [0590 7602](#) [TESTO 760-3](#) [0590 7603](#) [440012](#) [AX-155](#) [AX-174](#) [AX-178](#) [AX-18B](#) [AX-190A](#) [AX-503](#) [AX-507B](#) [AX-594](#) [AX-LCR42A](#) [AX-MS811](#) [AX-MS8250](#) [AX-PDM01](#) [AX-T520](#) [AX-T901](#) [AX-T903](#) [BAT-250-EUR](#) [BM525S](#) [BM805S](#) [BM807S](#) [BM817S](#) [BM827S](#) [BM829S](#) [BM857S](#) [BM859S](#) [BM867S](#) [BM907S](#) [33XR](#)