

**Model No.: GP85AAAHCE
GP85AAAHC**

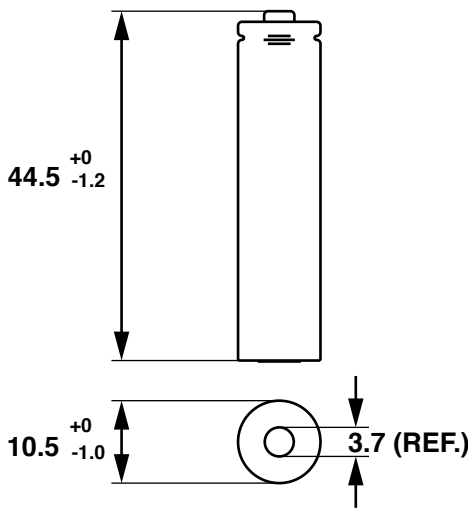

unit: mm

Applications Best For :



Benefits:

- Rechargeable, priceworthy and environmental friendly NiMH AAA battery
- Guaranteed to last for 6 years+ or 500 recharges, whichever comes first
- 5 times powers in taking more pictures compared to alkaline batteries*
- Stays charged up to 80% after 12 months
- 94%+ of the entire battery pack including the box can also be recycled
- Works in extreme temperatures: -20°C to +50°C
- Made from >10% recycled materials^

Specifications:

- Rated Capacity: 850mAh
- Size: AAA
- Voltage: 1.2V
- Charge retention: Up to 80% after 12 months
- Life cycle: Up to 500 cycles
- Operating temperature: -20°C to +50°C
- Weight: ~14.5g
- Validated with Environmental Claim Validation (ECV) certificate^

*Estimation based on internal test by GP. Result may vary by device and conditions of use.

*By KEMA report (Document no. 55106232-TOS/NET 10-4588), vs GP Super Alkaline batteries in digital cameras.

^For GP85AAAHCE only.

Battery handling :

- To maintain good battery performance for the first-time usage or after long term storage, please fully charge the battery before use. Cycling (i.e. charging and discharging) of the cell / battery a 6-9-month period is highly recommended.
- Do not solder directly to batteries and unplug a battery by holding the connector itself and not by pulling at its cord.
- Do not attempt to take batteries apart or subject them to pressure or impact. Heat may be generated, or fire may result. The alkaline electrolyte is harmful to eyes and skin, and it may damage clothing upon contact.
- Keep away from children. If swallowed the batteries, contact a physician at once.
- Ensure correct polarity when connecting the correct charger for NiMH batteries. Do not reverse charge batteries.
- When the battery is hot, please do not touch it and allow it to cool in a well-ventilated place out of direct sunlight before recharging.
- Avoid batteries being used in an airtight compartment. Ventilation should be provided inside the battery compartment; otherwise batteries may generate hydrogen gas, which could cause an explosion if exposed to an ignition source.
- If find any damaged sleeve, noise, excessive temperature or leakage from a battery, please do not use to avoid short circuit. Do not remove the outer sleeve from batteries.
- Do not incinerate, mutilate or soak batteries into water or sea water, may burst or release toxic material.
- Battery-powered devices and batteries should be stored in cool dry and ventilated places at room temperature staying away from direct sunlight.
- Do not short circuit batteries or place batteries with conductive materials, permanent damage to batteries may result.
- Remove all used batteries from the electrical device if the device is not going to be used for a long period of time and always replace used batteries with new batteries of same size and type.
- Do not mix new batteries in use with semi-used batteries or different types of batteries as it will affect the performance and conditions of your devices.
- The device should be switched off after the batteries are exhausted or find power down during use.
- Do not subject batteries to adverse condition such as extreme temperature, deep cycling and excessive over charge/over discharge.

Manufacturer reserves the right to alter or amend the design, model and specification without prior notice. Copyright@Gold Peak Group. All right reserved.



X-ON Electronics

Largest Supplier of Electrical and Electronic Components

Click to view similar products for [NiMH - Nickel Metal Hydride Battery](#) category:

Click to view products by [GP Batteries](#) manufacturer:

Other Similar products are found below :

[CL-R6/2X5-1500B](#) [100AAAHC B2](#) [4X 65AAAHCE](#) [75AAH](#) [100AAAHC B4](#) [270AAHCE-EB2](#) [380AFH](#) [210AAHCB-EB4](#) [85AAAHCB-EB2](#) [85AAAHCE-EB2](#) [SL-20X](#) [85AAAHCE-EB4](#) [210AAHCB-EB2](#) [NH-2100A](#) [NH-600AAA](#) [NH-B320](#) [270AAHCE-EB4](#) [HHR-26SCPY01](#) [HHR-300SCPY20](#) [NH-1500AA](#) [BK-110FHB01](#) [NH1250AA](#) [NH-3000SC](#) [65AAAHCE](#) [7638900416992](#) [7638900417005](#) [NH-1250AAL](#) [NH-7000D](#) [AA220](#) [AA220 ST](#) [ACCU-600/3NI-MH/CL](#) [ACCU-R14/2500/EG-B](#) [ACCU-R14/3000GP](#) [ACCU-R20/2500/EG-B](#) [ACCU-R22/175-EG](#) [ACCU-R3/750/DR](#) [ACCU-R6/2000-EG-B](#) [ACCU-SC/L-3000](#) [VH DL 9500](#) [VH FL 15000](#) [VHT 7/5CS](#) [VHT AAL](#) [VHT CS](#) [VHT D](#) [VHT F](#) [CL-R6/2S1P-1500B](#) [CL-R6/2X3-1500B](#) [CL-R6/2X4-1500B](#) [CL-R6/3S1P-1500B](#) [CL-R6/4S1P-1500B](#)