



## Series 34B: Sealed Miniature Toggle Switches

### SERIES 34B Sealed Miniature Toggle Switches

#### FEATURES

- Save Space and Weight
- SPDT, DPDT, and 3PDT Circuitry
- Choice of Actuators, Bushings and Terminations
- Sealed per IP67

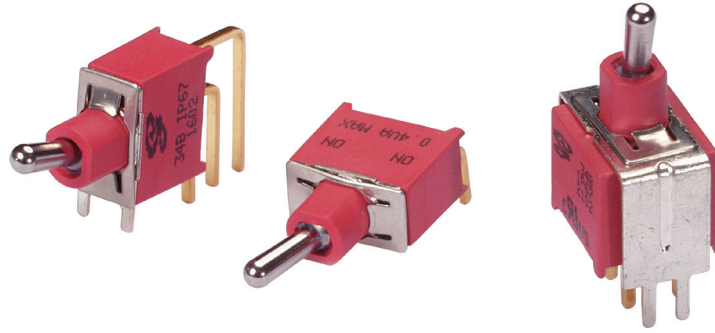

#### MODELS in inches (and millimeters)

##### SPDT

Model No.	Switching Position		
WSP1	ON	NONE	ON
WSP2	ON	NONE	(ON)
WSP3	ON	OFF	ON
WSP4	(ON)	OFF	(ON)
WSP5	ON	OFF	(ON)
Term. Comm.	2-3	OPEN	2-1

()=MOMENTARY

SCHEMATIC

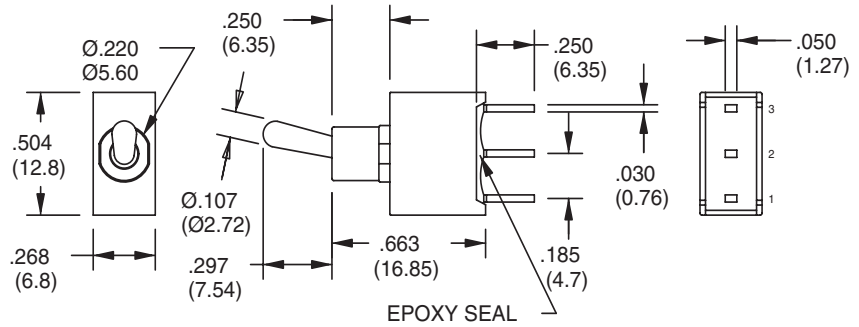

EPOXY SEAL

##### DPDT

Model No.	Switching Position		
WDP1	ON	NONE	ON
WDP2	ON	NONE	(ON)
WDP3	ON	OFF	ON
WDP4	(ON)	OFF	(ON)
WDP5	ON	OFF	(ON)
Term. Comm.	2-3 5-6	OPEN	2-1 5-4

()=MOMENTARY

SCHEMATIC

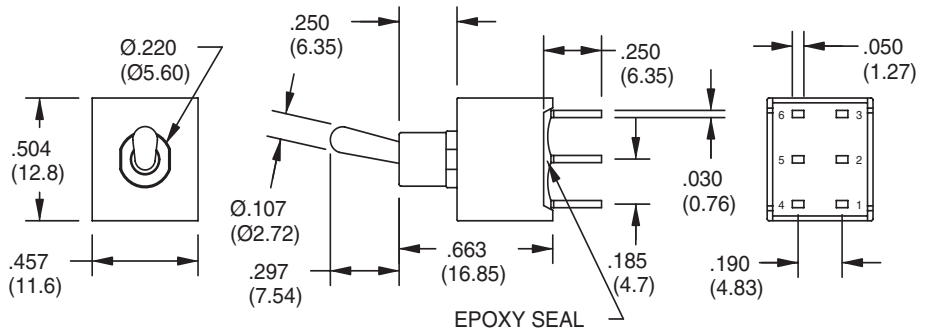

EPOXY SEAL

##### 3PDT

Model No.	Switching Position		
W3P1	ON	NONE	ON
W3P2	ON	NONE	(ON)
W3P3	ON	OFF	ON
W3P4	(ON)	OFF	(ON)
W3P5	ON	OFF	(ON)
Term. Comm.	2-3 5-6	OPEN	2-1 5-4

()=MOMENTARY

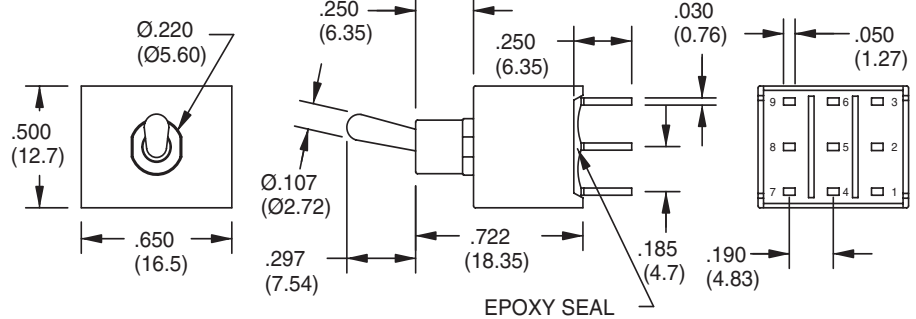
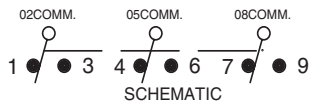

EPOXY SEAL

**ACTUATOR OPTIONS** in inches (and millimeters)

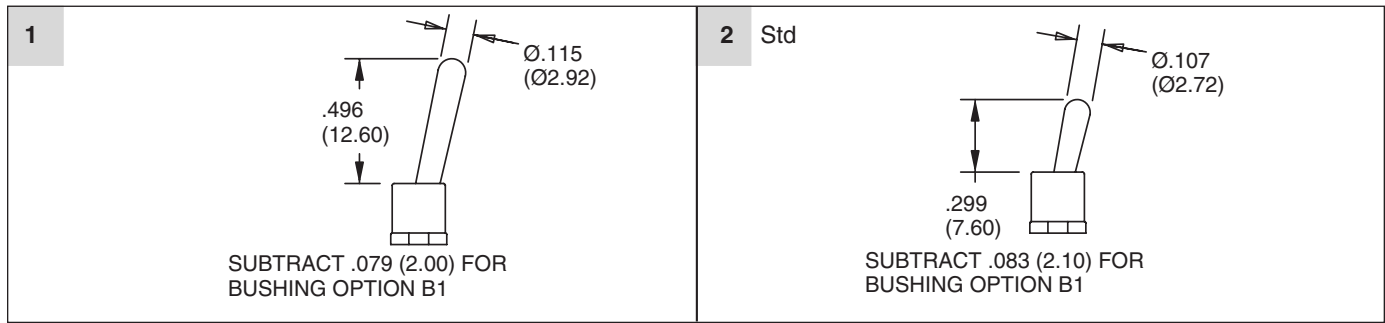

**BUSHING OPTIONS** in inches (and millimeters)

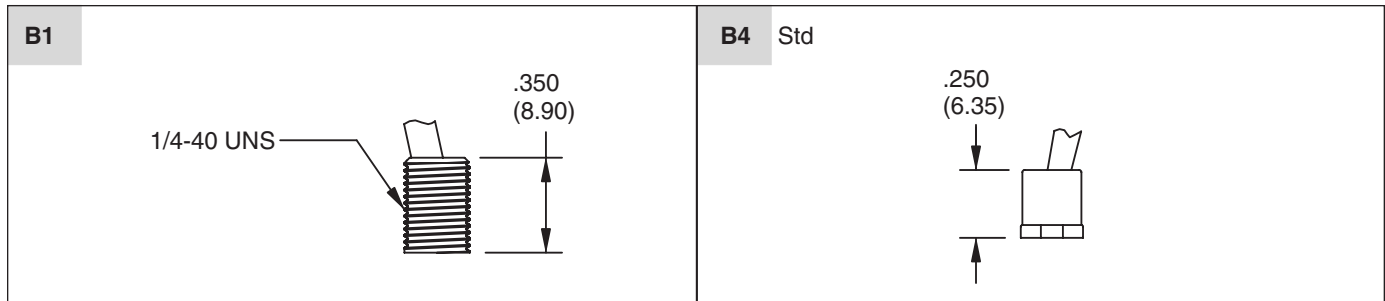

**TERMINATION OPTIONS** in inches (and millimeters)

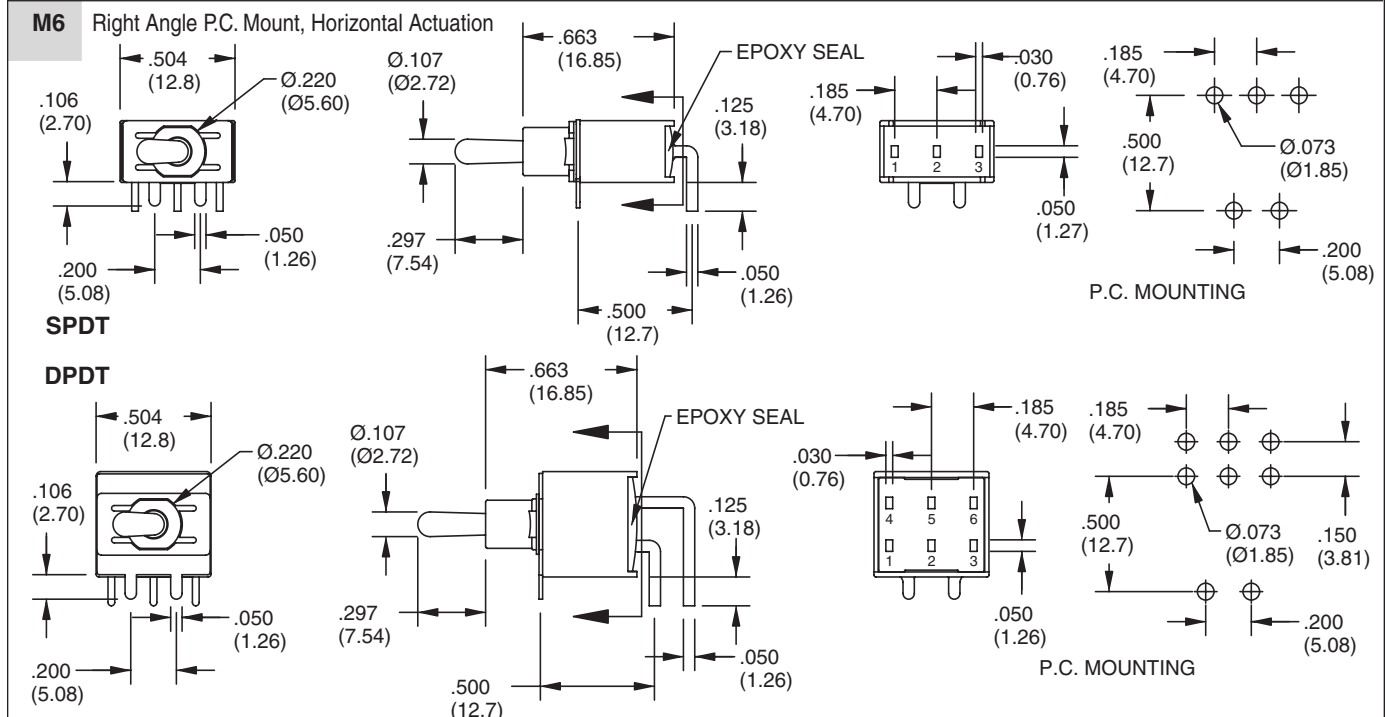
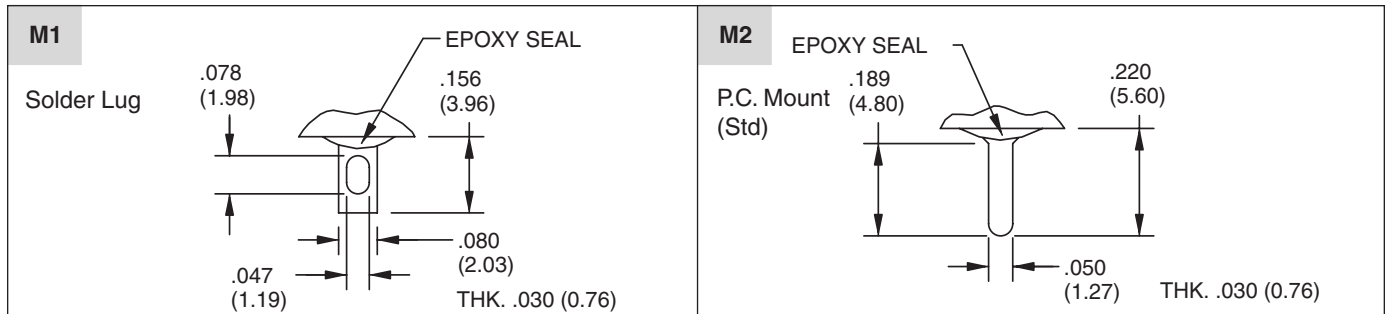

Toggle Switches



## Series 34B: Sealed Miniature Toggle Switches

### TERMINATION OPTIONS in inches (and millimeters)

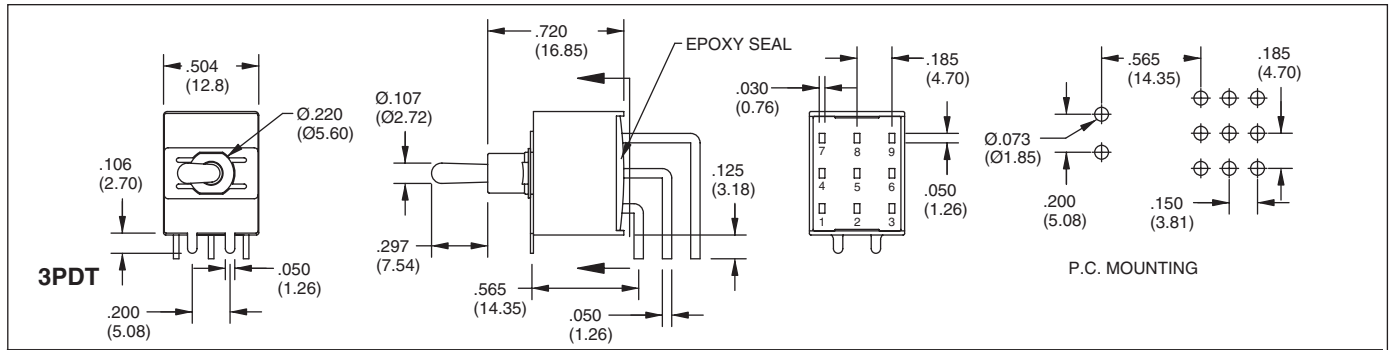

#### M7 Right Angle P.C. Mount, Vertical Actuation

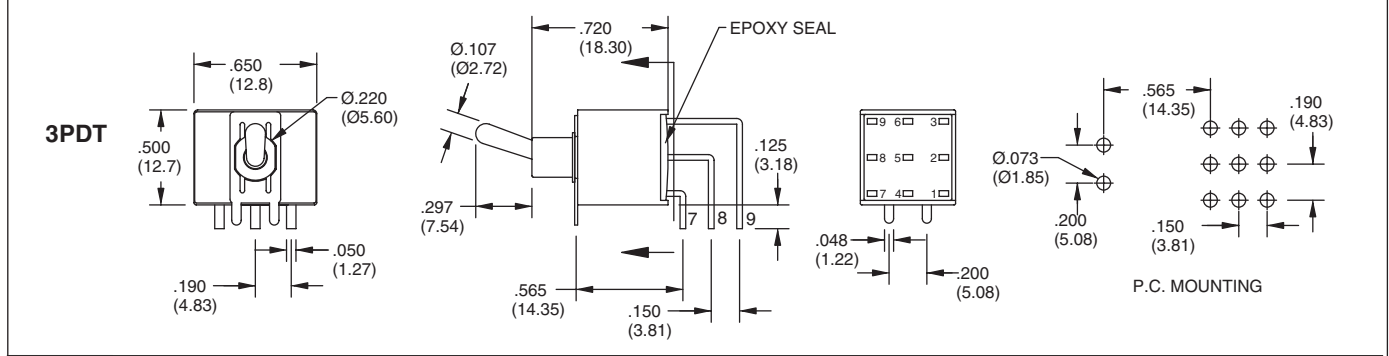
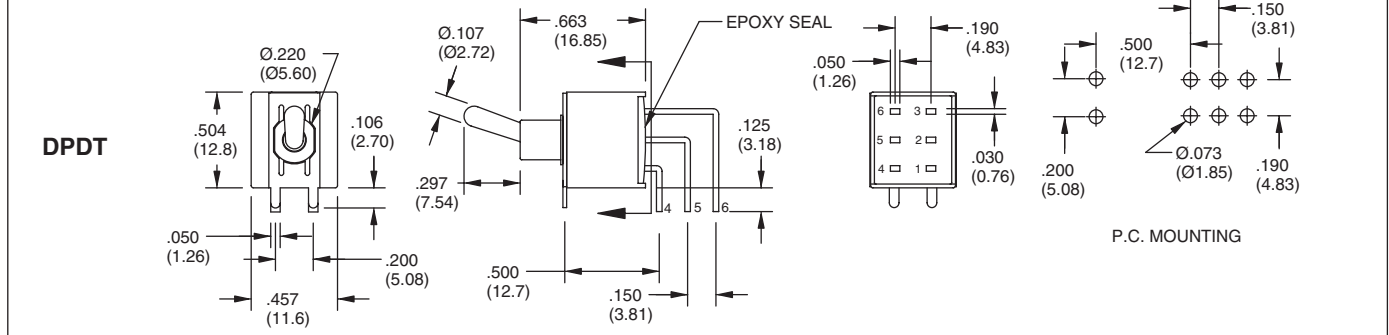
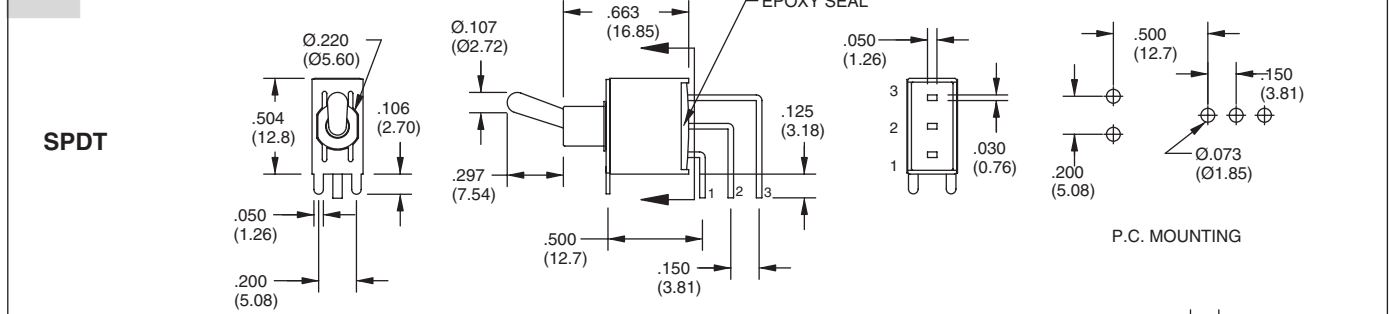

#### V2-V3 Vertical Bracket P.C. Mount

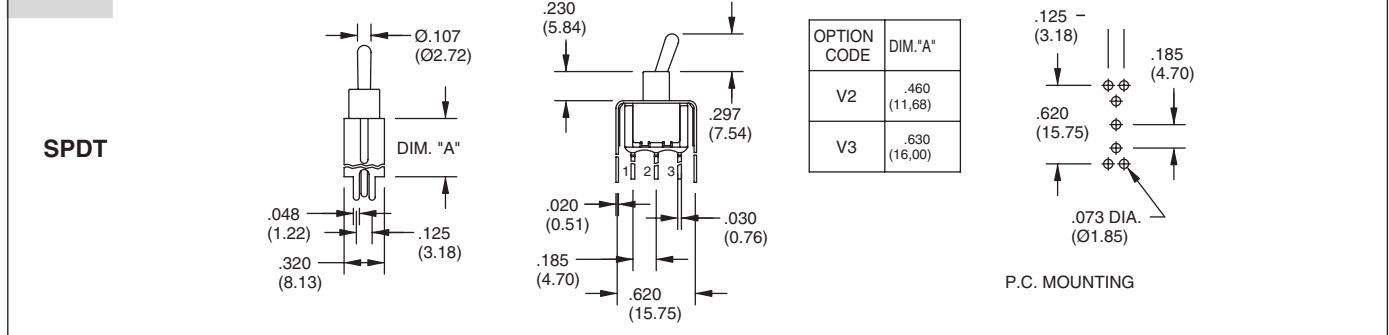

## Series 34B: Sealed Miniature Toggle Switches



### TERMINATION OPTIONS in inches (and millimeters)

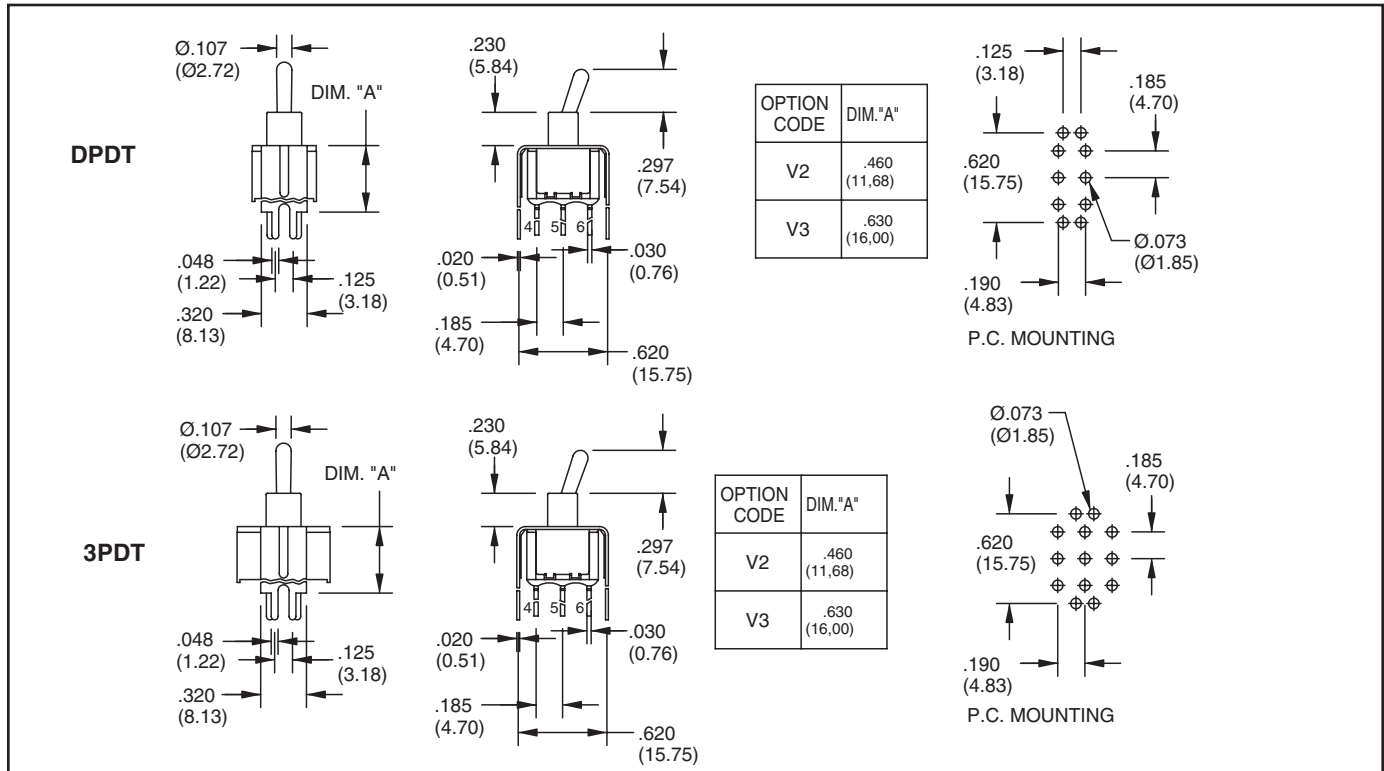

Toggle Switches

### SPECIFICATIONS

#### RATINGS

**Contact Rating:** Q option - 5A with resistive load @ 125VAC or 28 VDC; 2A with resistive load @ 250 VAC. R option-0.4 VA max @ 20 Vmax (AC or DC)

**Electrical Life:** 50,000 make-and-break cycles at full load

**Contact Resistance:** 10 milliohms max. initial @ 2-4 VDC, 100 mA

**Insulation Resistance:** 1,000 megaohms min  
**Dielectric Strength:** 1,500 V RMS @ sea level  
**Operating Temperature:** -30°C to 85°C

#### MATERIALS

**Case and Bushings:** Glass-filled nylon 6/6, flame retardant, heat stabilized (UL94V-0)  
**Frame:** Spring steel

**Actuator:** Brass, chrome plated. Internal O-ring seal standard with all actuators.

**Switch Support:** Brass, tin-plated

**Actuator Pivot & Mounting Bracket:** Nylon

**Actuator Pivot Retainer:** Stainless Steel

**Terminal and Contacts:** Copper alloy with plated over nickel or silver plate

**Terminal Seal:** Epoxy

### ORDERING INFORMATION

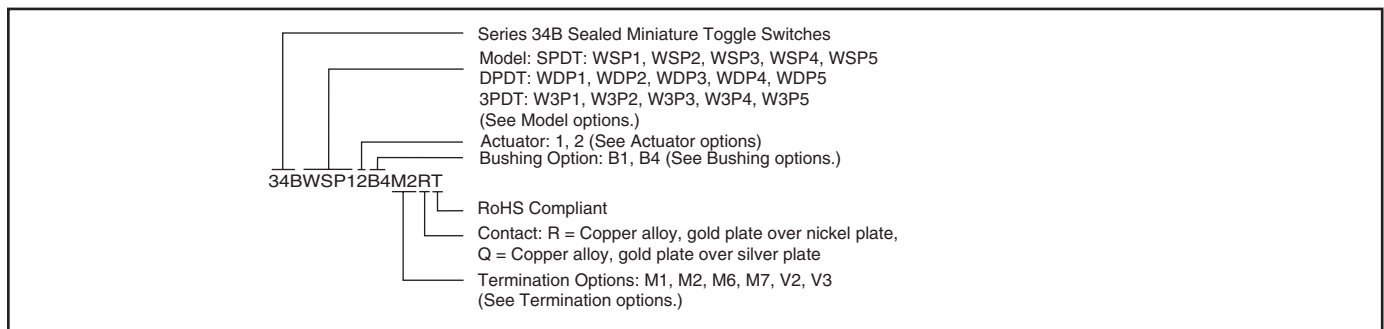

Available from your local Grayhill Component Distributor.

For prices and discounts, contact a local Sales Office, an authorized local Distributor or Grayhill.

### HARDWARE in inches (and millimeters)

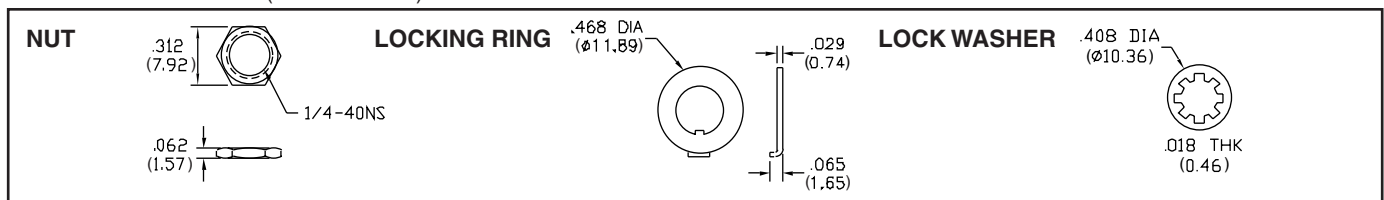

## X-ON Electronics

Largest Supplier of Electrical and Electronic Components

*Click to view similar products for [Toggle Switches](#) category:*

*Click to view products by [Grayhill](#) manufacturer:*

Other Similar products are found below :

[8928K478](#) [8A1-C-222](#) [020017-13](#) [60012L](#) [6006L](#) [CS115W](#) [CS120W](#) [6663](#) [7101SPDV30BE](#) [7103SDV30BE](#) [7105D](#) [7108P3YAV2BE](#)  
[71YY50282](#) [7300K36](#) [7301K38](#) [7306K36](#) [7310K36](#) [7506K4](#) [7592K6](#) [7660K12](#) [7691K14](#) [8391K108](#) [8396K108](#) [8812K14](#) [8824K14](#)  
[8828K13](#) [8835K3](#) [8858K44](#) [PS83-121G](#) [1-1825192-0](#) [A201SCWZB04](#) [A207SYCB04](#) [A208J61ZQ0004](#) [A221T1TCQ](#) [A323S1CWZQ](#)  
[A423S1CWZG-M8](#) [1201W](#) [12156AX408](#) [12147AGKX679](#) [12246X778](#) [12TW49-3D](#) [130312](#) [13037L](#) [13001X](#) [AE101MD1W4B04](#)  
[AE208SD1W4B04](#) [MS24659-22D](#) [MS27407-5](#) [1520230-9](#) [1520231-1](#)