

SERIES 39 SPST, 150 mA to 1/2 Amp

FEATURES

- Requires an Absolute Minimum of Space
- Molded-In Terminals in SPST-N.O.
- Solder Lug Terminals

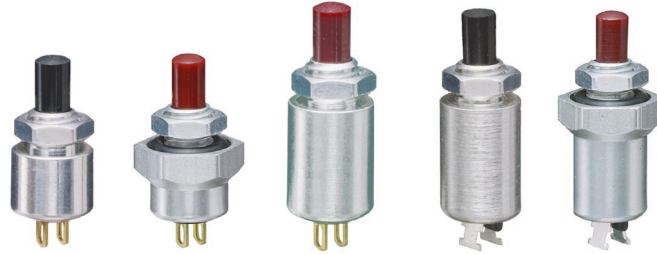

DIMENSIONS in inches (and millimeters)

Normally Open-SPST Economy and Standard Version

39-1
39-3
39-601*

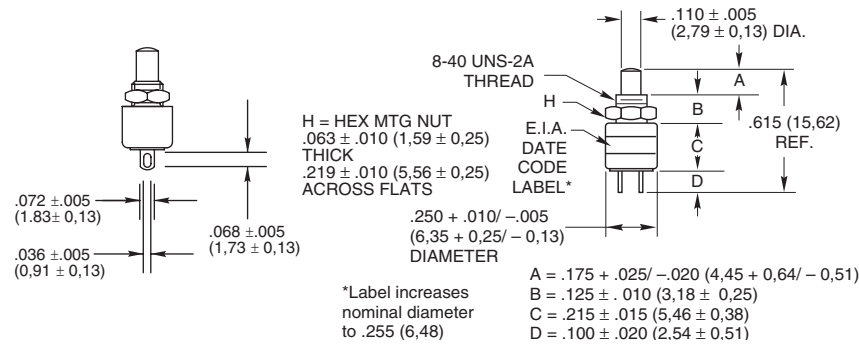

Economy Version

Electrical Ratings	Operations at Rated Load	*Complete Part Number	Button Color
At 5 Vdc 150 mA	At 20 Vdc 20 mA	1,000,000	39-601 RED 39-601 BLK

Action	Total Travel	Actuating Force (oz.)	Mtg. Hole
Momentary	.035 ± .015 (0,89 ± 0,38)	4 + 4 - 2	11/64" (4,37) DIA.

Standard

Electrical Ratings	Operations at Rated Load	Complete Part Number	Button Color
At 115 Vac 1/2 Amp Res.	At 220 Vac 1/4 Amp Res.	1,000,000	39-1 39-3

Action	Total Travel	Actuating Force (oz.)	Mtg. Hole
Momentary	.035 ± .015 (0,89 ± 0,38)	4 + 4 - 2	11/64" (4,37) DIA.

Normally Open-SPST with Sealed Bushing and Button

39-351*

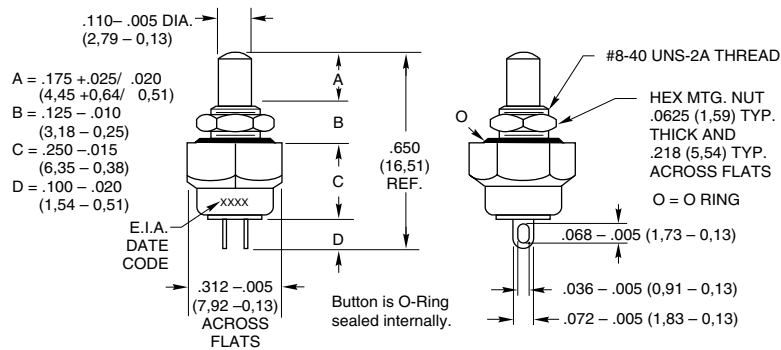

Rating at 115 Vac Resistive	Rating at 220 Vac Resistive	Operations at Rated Load	*Complete Part Number	Button Color
1/2 Amp	1/4 Amp	250,000	39-351 RED 39-351 BLK	Red Black

Action	Total Travel	Actuating Force (oz.)
Momentary	.035 ± .015 (0,89 ± 0,38)	16 ± 8

Normally Open-SPST with Overtravel

39-12
39-24

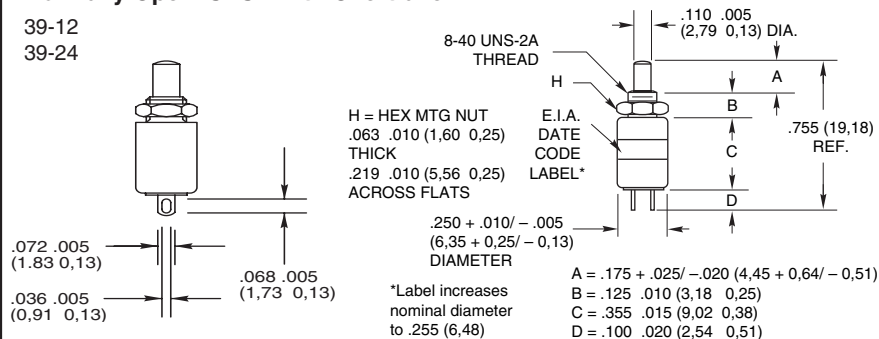

Rating at 115 Vac Resistive	Rating at 220 Vac Resistive	Operations at Rated Load	Complete Part Number	Button Color
1/2 Amp	1/4 Amp	100,000	39-12 39-24	Red Black

Action	Total Travel	Over Travel	Actuating Force (oz.)	Mtg. Hole
Momentary	.130 ± .025 (3,30 ± 0,64)	.015 (0,38) Min.	5 ± 3	11/64" (4,37) DIA.

Pushbutton Switches



Butt Contact Pushbutton Switches

DIMENSIONS in inches (and millimeters)

Normally Closed-SPST

39-2

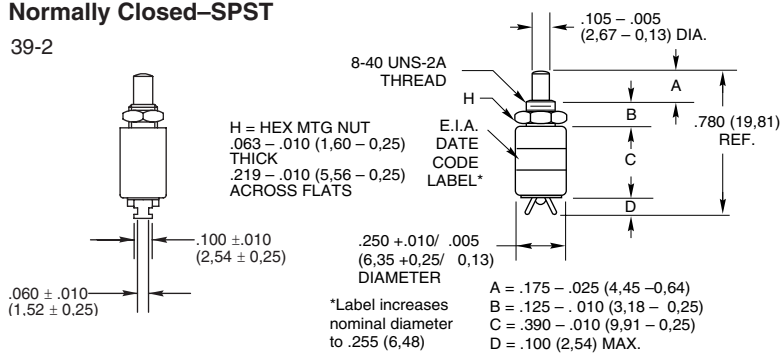

Rating at 115 Vac Resistive	Rating at 220 Vac Resistive	Operations at Rated Load	Part Number	Cap Color
1/4 Amp	1/8 Amp	250,000	39-2	Black

Action	Total Travel	Actuating Force (oz.)	Mtg. Hole
Momentary	.042 ± .010 (1.07 ± 0.25)	4 + 4 - 2	.172 (4.37) DIA.

Normally Closed-SPST with Sealed Bushing and Button

39-352*

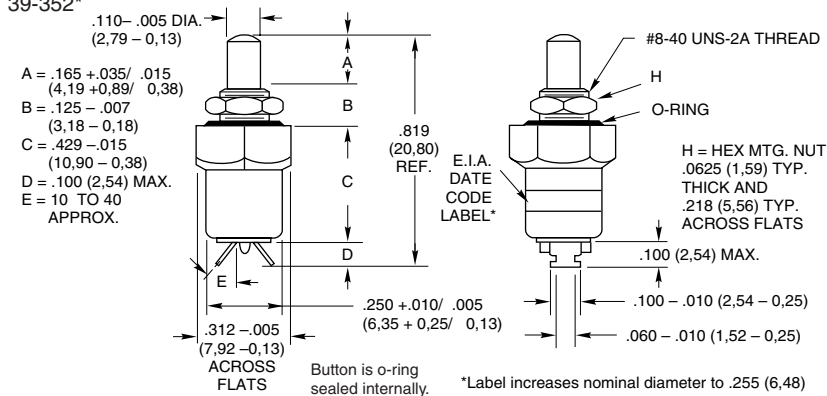

Rating at 115 Vac Resistive	Rating at 220 Vac Resistive	Operations at Rated Load	*Complete Part Number	Button Color
1/4 Amp	1/8 Amp	100,000	39-352 RED 39-352 BLK	Red Black

Action	Total Travel	Actuating Force (oz.)
Momentary	.042 ± .010 (0.17 ± 0.25)	8 ± 4

CIRCUITRY

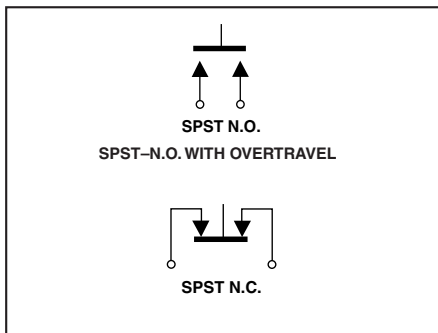

Materials and Finishes

Mounting Nut: Brass, tin zinc

Housing: Aluminum, clear anodized for 39-351 and 39-352; Brass, zinc trivalent chromate-plated for others

Button: Thermoset plastic

Base: Thermoset plastic

Shorting Bar: Fine silver for 39-2 and 39-352; brass, gold-plated over nickel plate for 39-601; fine silver, gold-plated for others

Terminals: Fine silver for 39-2 and 39-352; commercial bronze with gold-plated fine silver contact surface for others

Spring: Tinned music wire

O-Rings: (39-351 and 39-352) Internal ring is silicone; external ring is buna 'N'

ACCESSORY

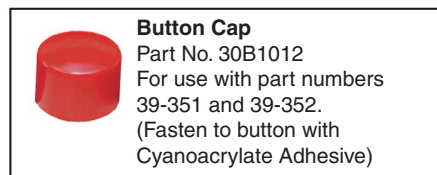

Accessory Part Number	Description
30B1012-5	Red Button Cap
30B1012-9	Black Button Cap
30B1012-8	White Button Cap

ORDERING INFORMATION

Part Number	Description
39-1	N.O., Red Button
39-2	N.C., Black Button
39-3	N.O., Black Button
39-12	N.O., Overtravel Red Button
39-24	N.O., Overtravel Black Button
39-351 RED	N.O., Sealed, Red Button
39-351 BLK	N.O., Sealed, Black Button
39-352 RED	N.C., Sealed, Red Button
39-352 BLK	N.C., Sealed, Black Button
39-601 RED	N.O., Economy, Red Button
39-601 BLK	N.O., Economy, Black Button

Accessory cap may be used with all switches shown except 39-2.

RECOMMENDED PANEL CUTOUT

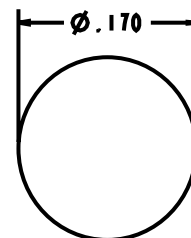

SPECIFICATIONS

Rating Criteria

Contact Resistance: 25 milliohms maximum on a new switch

Voltage Breakdown: 1,000 Vac between mutually insulated parts

Insulation Resistance: 1,000 megohms minimum

Operating Temperature: -40°C to +85°C

Mounting Torque: 2 inch-pounds



Pushbutton Engineering Information

Pushbutton switches are selected not only by their ratings, but also by their contact type. While nearly all rotary switches and DIP switches have wiping contacts, pushbutton switches may have either wiping or butt contacts (see internal views below).

Wiping Contacts are self-cleaning and usually provide a low resistance in circuits where contact resistance is critical. However, the wiping action creates mechanical wear and conductive wear products.

Butt Contacts have less wear than wiping contacts and therefore, have a longer life. They are also smaller. Butt contacts are not self-cleaning, so their contact resistance can vary from operation to operation.

Snap Action switches are basically butt contact switches with a spring mechanism which provides the make and break. The mechanism controls both the operating point and the rate of operation, but adds to the wear of

the switch. The rapid rate of make and break means that these switches are appropriate for high current loads. They usually have a slight wiping action and contact surfaces made of precious metals to minimize their disadvantages.

Internal Views of Pushbutton Switches

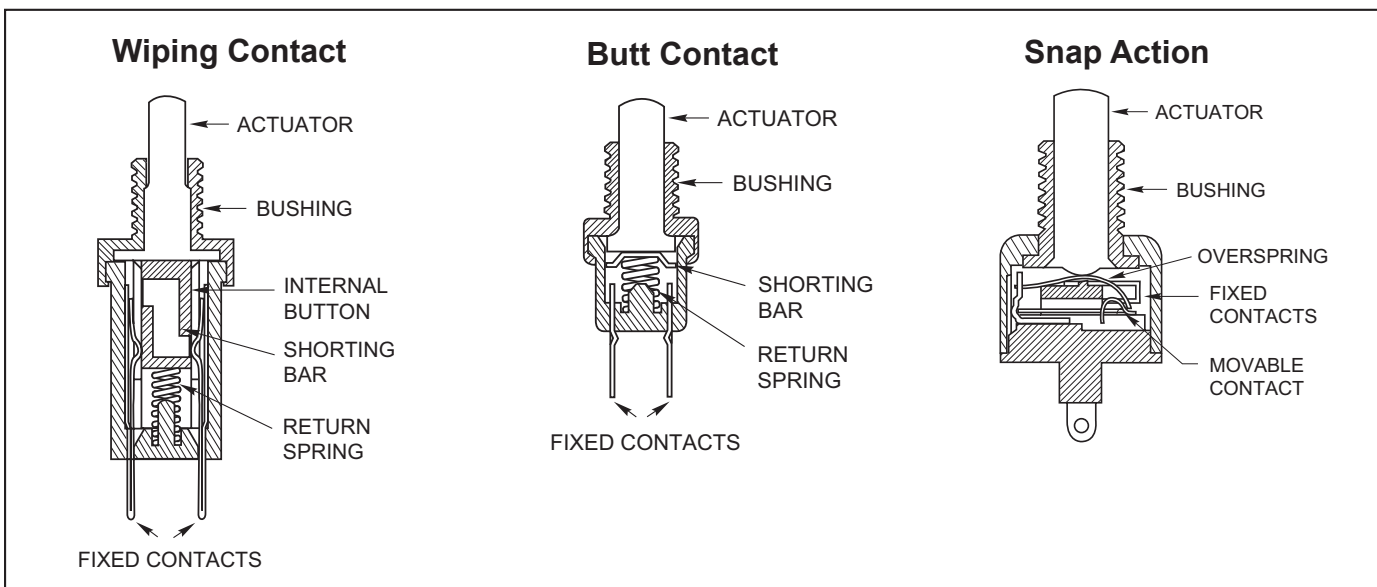

Switch Terminology

Actuator: The part of the switch to which an external force is applied to operate the switch.

Alternate Action (Push-Push) Switch: A switch in which the operable position is maintained after the first actuation, and then disengaged with the second operation.

Break-Before-Make Switch (BBM): A double throw switch in which the moving contact breaks the connection with the first circuit before making contact with the second; also called non-shortening switch.

Double Throw Switch: A switch which has a normally open as well as a normally closed circuit per pole.

Joystick Action Switch: (From Joystick, the control for an airplane). A lever switch which operates with momentary action in 4 directions, and is disengaged in the upright position.

Make-Before-Break Switch (MBB): A double throw switch in which the contacts makes connection with the second circuit before breaking contact with the first; also called shorting switch.

Maintained Contact Switch: A switch in which the actuator remains in a position until it is actuated to another position where it also remains until actuated. Example: Push-Pull Switch.

Momentary Contact Switch: A switch in which the shorting bar returns from its operated position to its normal or free position when the actuating force is removed.

Operating Position or Point: The position of the actuator when the desired electrical action (make or break of contact) occurs.

N.C., Normally Closed: Switch in which the circuit is closed without actuation (with actuator in the "normal" position).

N.O., Normally Open: Switch in which the circuit is open without actuation (with actuator in the "normal" position).

Overtravel: The distance or angle between the operating position and the extreme position to which the actuator may be moved.

Pole: An electrically isolated circuit within a switch; a common terminal and all the selected terminals to which it connects.

Pretravel: The distance or angle through which the actuator moves from its free position to its electrical operating position.

Single Throw Switch: A switch which has only one normally open or one normally closed circuit per pole.

Throw: See Single Throw and Double Throw.



Circuitry*	Rating (Amps at 115 Vac Res.)	Operations At Rating	Maximum Width*** inch (mm)	Features	Series
------------	-------------------------------	----------------------	----------------------------	----------	--------

Butt Contact

SPST	N.O. or N.C.	5	6,000	3/8 (9,53)	UL Listed	30	
	N.O. or N.C.	1	1,000,000	3/8 (9,53)	Momentary, Terminal Seal, (Wire Leads Optnl.)	30	
	N.O.	1	500,000	3/8 (9,53)	Overtravel, Terminal Seal, (Wire Leads Optnl.)	30	
	N.O.	1	200,000	11/16 (17,46)	Positive Feel, Overtravel, Terminal Seal, (Wire Leads Optional)	30	
	On or Off	1	100,000	11/16 (17,46)	Push/Pull Action (Maintained)	30	
	N.O. or N.C.	1	250,000	1/2 (12,7)	Watertight, Terminal Seal, (Wire Leads Optnl.)	30	
	N.O.	1	1,000,000	11/16 (17,46)	Square & Round Bezels	30	
	N.O. or N.C.	1	1,000,000	1+ (25,4)	Square Bezel Panel Mount	30	
	N.O.	1	200,000	11/16 (17,46)	Pos. Feel, Overtravel, Square & Round Bezels	30	
	N.O.	1	200,000	11/16 (17,46)	Pos. Feel, Overtravel, Sq. Bezel Panel Mount	30	
	N.O.	.020**	80,000	5/16+ (8,13)	Miniature, Surface Mount	38	
	N.O.	.020**	80,000	5/16+ (8,13)	Miniature, Horizontal PC Mount	38	
	N.O.	.020**	80,000	5/16+ (8,13)	Miniature, Vertical to PC Mount	38	
	N.O. or N.C.	.250	100,000	1/4 (6,35)	Sealed Plunger, Stackable with LEDs	32	
	N.O.	.500	1,000,000	1/4 (6,35)	Miniature	39	
	N.O.	.500	500,000	1/2 (12,7)	Overtravel, Miniature Limit Switch, (Wire Leads Optional)	39	
	N.O.	.500	100,000	1/2 (12,7)	Overtravel, Miniature, (Wire Leads Optional)	39	
	N.O.	.500	250,000	5/16 (7,94)	Watertight Seal, Miniature, (Wire Leads Optional)	39	
	N.C.	.250	250,000	1/4 (6,35)	Miniature (Wire Leads Optional)	39	
	N.C.	.250	100,000	5/16 (7,94)	Watertight Seal, Miniature, (Wire Leads Optnl.)	39	
	N.C.	.250	100,000	1/2 (12,7)	Actuator Seal, Miniature Limit Switch (Wire Leads Optional)	39	
	N.O.	.150**	1,000,000	1/4 (6,35)	PC Mount, Miniature, Sealed	39	
	N.O.	.150**	1,000,000	1/4 (6,35)	PC Mount, Miniature, Right Angle, Cap Seal	39	
	N.O.	.150**	100,000	1/4 (6,35)	PC Mount, Miniature, Overtravel	39	
	N.O.	.020, .150**	1,000,000	3/8 (9,53)	Economical Contact Plating	30	
	N.O.	.020, .150**	1,000,000	3/8 (9,53)	Econ. Plating, Square Bezel Panel Mount	30	
	N.O.	.020, .150**	1,000,000	1/4 (6,35)	Economical Contact Plating	39	
	N.O.	.020, .150**	100,000	1/2 (12,7)	Actuator Seal, Overtravel, Miniature Limit Switch, (Wire Leads Optional)	39	
	SPDT	BBM	.250	100,000	1/4 (6,35)	SPST AND SPDT, Stackable w/LEDs	32
		BBM	.250	500,000	1/2 (12,7)	PC Mount, 2 Circuits, Right Angle, Total Seal	39
BBM		.020**	80,000	5/16 (8,13)	Miniature, Surface Mount	38	

Wiping Contact

SPST	N.O. or N.C.	3	6,000	13/16 (20,6)	Decorator Line	4000/10
	N.O. or N.C.	1	100,000	13/16 (20,6)	Momentary Action & Positive Feel Types	4000/10
	N.O.	.250	100,000	1/2 (12,7)	Momentary Action & Terminal Seal Types	23
	N.O.	.4VA	40,000	.177 (4,5)	Process Sealed, Subminiature	49
SPDT	BBM or MBB	.250	250,000	7/16 (11,11)	Momentary Action	46
	BBM or MBB	.250	250,000	1+ (25,4+)	Square Bezel Panel Mount	46
	BBM or MBB	.250	100,000	1/2 (12,7)	Watertight Seal	46
	BBM	.250	250,000	11/16 (17,46)	Square & Round Bezels	46
	BBM	.250	250,000	11/16 (17,46)	Alternate Action, Square & Round Bezels	46
	BBM	.250	250,000	1+ (25,4+)	Alternate Action, Square Bezel Panel Mount	46
DPDT	BBM or MBB	.250	100,000	5/8 (15,88)	Momentary Action	46
	BBM	.250	250,000	13/16 (20,6)	Environmental Seal/Wire Leads	46
	BBM or MBB	.250	100,000	11/16 (17,46)	Watertight Seal	46
	BBM	.250	250,000	11/16 (17,46)	Square & Round Bezel & Positive Feel Types	46
	BBM	.250	250,000	11/16 (17,46)	Alternate Action, Square & Round Bezels	46
	BBM or MBB	.250	250,000	1+ (25,4+)	Alternate Action, Square Bezel Panel Mount	46

Snap Action Contact

SPST	N.O. or N.C.	1, 3	25,000	7/8 (22,23)	SPST, 1 and 3 Amp	4000/10
SPDT	BBM	5, 10	25,000	7/8 (22,23)	Audible Click	2000/7

* BBM is Break-Before-Make (Non-Shorting). MBB is Make-Before-Break (Shorting).

** Rated for 28 Vdc and/or 5 Vdc (.150 A) and 20 Vdc (.020 A).

*** Maximum width behind panel or above PC board rounded to next highest 1/16" (1,59 mm).



Pushbutton Options and Accessories

SEALED TERMINAL AND WIRE LEAD OPTIONS OPTION -E AND -EW

FEATURES

- 1/4, 1/2, and 1 Amp
- Limit, Overtravel, or Panel Seal
- Butt or Wiping Contact
- Normally Open or Normally Closed
- Momentary or Push/Pull
- Series 23, 30, 39 and 46



Option -E
Epoxy-Sealed
Terminals

Option -EW,
Potted Base & 6"
Wire Leads



SPECIFICATIONS

Rating Criteria

Make and Break Current Rating: See page for standard part number

Contact Resistance: 25 milliohms maximum on a new switch. Less than 4 milliohms per inch of wire for wire lead option styles.

Insulation Resistance: 1,000 megohms minimum between mutually insulated parts

Voltage Breakdown: 1,000 Vac minimum between mutually insulated parts

Materials and Finishes

Potting Sleeve (Series 39): Thermoset Plastic

Wire Leads: #26AWG, (.99mm diameter) insulated Teflon, Copper stranded wire, per MIL-W-16878, Type E. Ends are stripped 0.250" (6.35) and solder dipped. For other specifications, see Page References.

Standard Part Number Red Button	Standard Part Number Black Button	Choices of Suffix	Length Behind Panel In inches (and millimeters)	
			Standard Switch & Terminals	-EW Style Body
23-1	23-4	-E	0.665 (16,89)	—
30-1	30-3	-E, -EW	0.592 (15,04)	0.645 (16,38)
30-15	30-37	-E, -EW	0.679 (17,25)	0.728 (18,49)
30-17 RED	30-17 BLK	-E, -EW	0.958 (24,33)	1.007 (25,58)
30-16 RED	30-16 BLK	-E, -EW	0.958 (24,33)	1.007 (25,58)
30-251 RED	30-251 BLK	-E, -EW	0.632 (16,05)	0.685 (17,40)
30-252 RED	30-252 BLK	-E, -EW	0.645 (16,38)	0.700 (17,78)
30-32 RED	30-32 BLK	-E, -EW	0.867 (22,02)	0.896 (22,76)
30-6	30-2	-E, -EW	0.605 (15,37)	0.640 (16,26)
30-601 RED	30-601 BLK	-E, -EW	0.592 (15,04)	0.645 (16,38)
39-1*	39-3*	-EW**	0.315 (8,00)	0.440 (11,18)
39-12*	39-2	-E, -EW	0.490 (12,45)	0.575 (14,61)
39-101	39-24*	-EW**	0.455 (11,56)	0.575 (14,61)
39-351 RED	39-351 BLK	-EW**	0.650 (16,51)	0.775 (19,69)
39-352 RED*	39-352 BLK*	-E, -EW	0.350 (8,89)	0.450 (11,43)
39-601 RED	39-601 BLK	-E, -EW	0.529 (13,44)	0.630 (16,00)
39-701***	—	-EW*	0.315 (8,00)	0.440 (11,18)
39-702***	—	-EW**	0.800 (20,32)	0.925 (23,50)
46-101 RED	46-101 BLK	-E, -EW	0.510 (12,95)	0.750 (19,05)
46-102 RED	46-102 BLK	-E, -EW	0.890 (22,61)	0.957 (24,31)
46-110 RED	46-110 BLK	-E, -EW	0.890 (22,61)	0.957 (24,31)
46-111 RED	46-111 BLK	-E, -EW	0.890 (22,61)	0.957 (24,31)
46-150 RED	46-150 BLK	-E, -EW	0.890 (22,61)	0.957 (24,31)
46-151 RED	46-151 BLK	-E, -EW	0.957 (24,31)	1.024 (26,01)
46-200 RED	46-200 BLK	-E	0.957 (24,31)	1.024 (26,01)
46-201 RED	46-201 BLK	-E	0.921 (23,39)	—
46-270 RED	46-270 BLK	-E	0.921 (23,39)	—
46-271 RED	46-271 BLK	-E	0.957 (24,31)	—

*Epoxy potting sleeve enlarges the diameter of the -EW style to 0.300 (7,62).

**Sealed terminal (-E) option is not necessary; terminals have sealed construction.

***Natural Color Button

†Adjustable from 1.214 (30,84) to 1.334 (33,88) dependent on button height, see switch pages.

ORDERING INFORMATION

Use the Selector Charts at the beginning of the section to select a series. Use the pages listed there or referenced here to select a switch.

To order epoxy sealed terminals, add the suffix -E to the selected part number as allowed in the chart. **Example:** 30-1-E.

To order the epoxy-potted version with 6-inch wire leads, use the suffix -EW as allowed in the chart. **Example:** 39-1-EW

Available From Your Local Grayhill Distributors. For prices and discounts, contact a local Sales Office, an authorized local Distributor or Grayhill.

Standard Part Number Without Options Choice of Button Color (see switch pages)	Standard Part Number Choice of Button Color (see switch pages)	Choices of Options	Length Behind Panel In inches (and millimeters)	
			Standard Switch & Terminals	-EW Style Body
—	30-001-A-XX	-E, -EW	1.119 (28,42)	1.172 (29,77)
—	30-002-A-XX	-E, -EW	1.132 (28,75)	1.167 (29,64)
—	30-015-A-XX	-E, -EW	1.204 (30,58)	1.253 (31,83)
—	30-017-A-XX	-E, -EW	Adjustable†	Adjustable†
30-01-01-500-XX	30-1-1-50-XX	-E, -EW	1.100 (27,94)	1.153 (29,29)
30-01-04-500-XX	30-1-4-50-XX	-E, -EW	1.257 (31,93)	1.310 (33,27)
30-05-01-502-XX	30-5-1-52-XX	-E, -EW	0.930 (23,62)	0.983 (24,97)
30-05-04-502-XX	30-5-4-52-XX	-E, -EW	1.130 (28,70)	1.183 (30,05)
—	30-601-A-XX	-E, -EW	1.119 (28,42)	1.172 (29,77)
46-01-07-500-XX	46-1-7-50-XX	-E, -EW	1.451 (36,86)	1.518 (38,56)
46-01-08-500-XX	46-1-8-50-XX	-E	1.381 (35,08)	—
46-01-09-500-XX	46-1-9-50-XX	-E	1.381 (35,08)	—
46-05-05-502-XX	46-5-5-52-XX	-E, -EW	1.179 (29,95)	1.246 (31,65)
46-05-07-502-XX	46-5-7-52-XX	-E, -EW	1.465 (37,21)	1.532 (38,91)
46-05-08-502-XX	46-5-8-52-XX	-E	1.188 (30,18)	—
46-05-09-502-XX	46-5-9-52-XX	-E	1.317 (33,45)	—
—	46-102-A-XX	-E, -EW	1.417 (35,99)	1.484 (37,69)
—	46-111-A-XX	-E, -EW	1.417 (35,99)	1.484 (37,69)
—	46-200-A-XX	-E	1.448 (36,78)	—
—	46-201-A-XX	-E	1.448 (36,78)	—

CIRCUITRY: Series 46

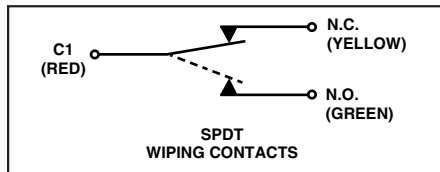

*Epoxy potting sleeve enlarges the diameter of the -EW style to 0.300 (7,62).
 **Sealed terminal (-E) option is not necessary; terminals have sealed construction.
 ***Natural Color Button
 †Adjustable from 1.214 (30,84) to 1.334 (33,88) dependent on button height, see switch pages.

Pushbutton Switches



Pushbutton Options and Accessories

ACCESSORIES

For Pushbutton Switches



DIMENSIONS In Inches (and millimeters)

Decorative Mounting Nuts

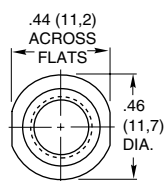

30C1023-1

Brass, nickel-plated for 1/4" (6,35) bushing.

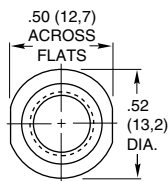
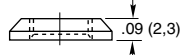

23C1024-1

Brass, nickel-plated for 5/16" (7,93) bushing.

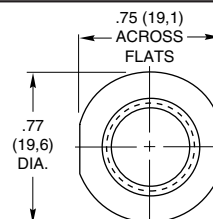
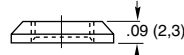

07C1040-1

Brass, nickel-plated for 15/32" (11,9) bushing.

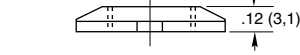

Button Caps and Guard

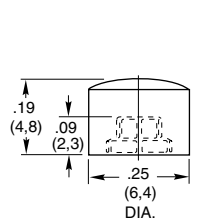

30B1012

Thermosetting plastic (Fasten to button with cyanoacrylate adhesive) black, red or white.
For use with all Series 30 and 39 switches except part number 39-101. See switch pages.

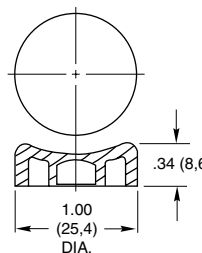

07Z1047

Thermoplastic, black or red color.
For use with Series 2000 and Series 7 switches. See switch pages.

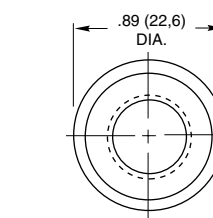

10C1015-1

Brass, zinc trivalent chromate-plated for 15/32" (11,9) bushing.

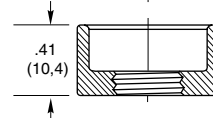

Remote Switching Accessories Pendant Housing and Caps

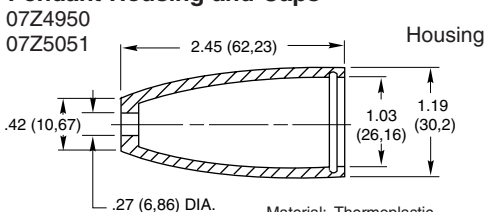

07Z4950
07Z5051

Material: Thermoplastic
Specials: other colors available on special order.

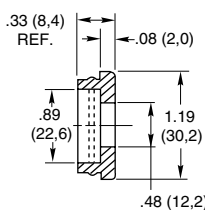

Flat Cap

Application:

All grayhill pushbutton switches with 15/32-32 bushings: catalog numbers 2201, 2202, 07-7, 07-8, 07-21, 07-22, 07-26, 4001, 4002, 10-9, 10-10, 10-100, 10-101, 30-16, 30-17 and 30-32. any other switch with 15/32-32 bushing if it fits housing.

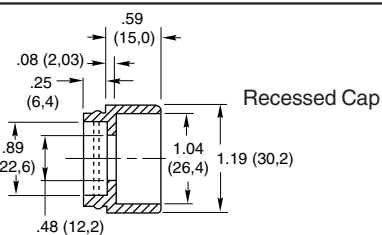

Recessed Cap

ORDERING INFORMATION:

Mounting Nuts, Button Caps, and Guards

Part Number	Color
07C1040-1	Decorative Nut
23C1024	Decorative Nut
30C1023-1	Decorative Nut
07Z1047-1 BLK	Black Button Cap
07Z1047-2 RED	Red Button Cap
10C1015-1	Button Guard
30B1012-5	Red Cap
30B1012-8	White Cap
30B1012-9	Black Cap

Pendant Housing and Caps

Part Number	Description
07Z4950 RED	Red Flat Cap & Housing
07Z4950 BLK	Black Flat Cap & Housing
07Z5051 RED	Red Rcssid Cap & Housing
07Z5051 BLK	Black Rcssid Cap & Housing

Sold only as sets of one housing and one cap.

Available from your local Grayhill Distributor.

For prices and discounts, contact a local Sales Office, an authorized local Distributor, or Grayhill.

X-ON Electronics

Largest Supplier of Electrical and Electronic Components

Click to view similar products for [Pushbutton Switches](#) category:

Click to view products by [Grayhill](#) manufacturer:

Other Similar products are found below :

[8940K2012](#) [LW1L-M1C10V-A](#) [LW1L-M1C70-A](#) [LW2L-A1C20M-GD](#) [LW2L-M1C20M-A](#) [60324L](#) [M22-D-R-GB0/K11](#) [M7E-HRN2](#)
[67021K512](#) [67081K512X](#) [701PB580](#) [7199K101](#) [810K12910](#) [810KSV30B](#) [MML21EA2ADK](#) [MML21KA3ABK](#) [MML23KA3AC05K-001](#)
[MML23KW3AA01W](#) [8418K2](#) [8442K3](#) [8450K1](#) [860K11911T01A](#) [861901](#) [861K11911T01A07](#) [861K13810T00A14](#) [861K13911](#)
[8646AB6X718UL](#) [8646ABUL](#) [9001KXRK](#) [907AYY100](#) [PMHD155A1](#) [9533CD4+U574+U4922](#) [95-414.000](#) [99-450.837](#) [99-453.837](#)
[PV3H2B0NN-341](#) [1203MRA](#) [A22NZBGANGA](#) [A22NZBNANGA](#) [A22NZMPATRA](#) [A2PMA1X03EC56](#) [A3A-5123-02](#) [A3A-7140](#) [A3A-7310](#) [A3A-7340](#) [A3U-TMW-A2C-5M](#) [A595](#) [12037A2ULCSA](#) [ABD122N-B](#) [1211390004](#)