

SERIES 94H Binary Coded

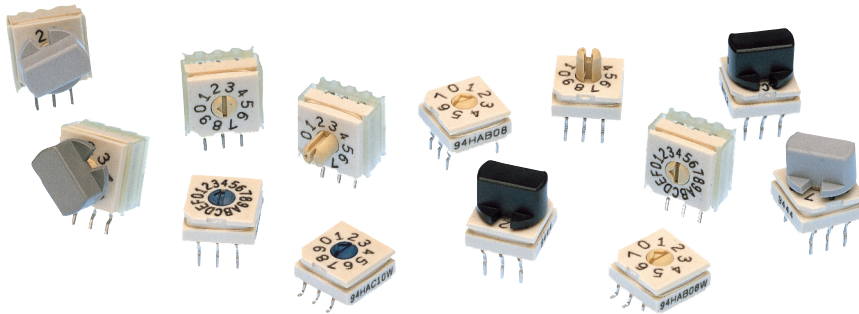

DIMENSIONS in inches (and millimeters)

Tolerances are $\pm .010$ inches unless specified otherwise.

Surface Mount Gullwing

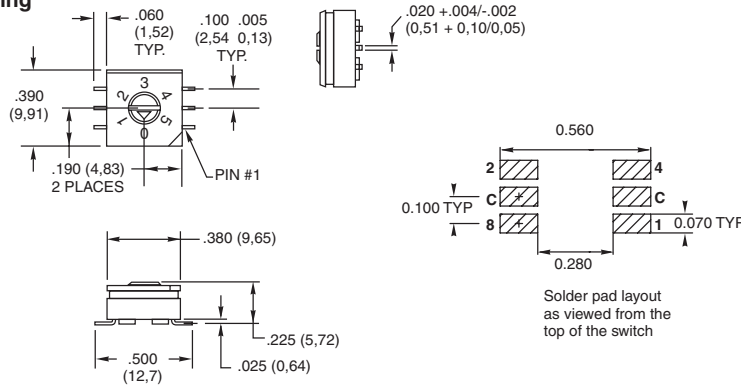

Surface Mount J-Lead

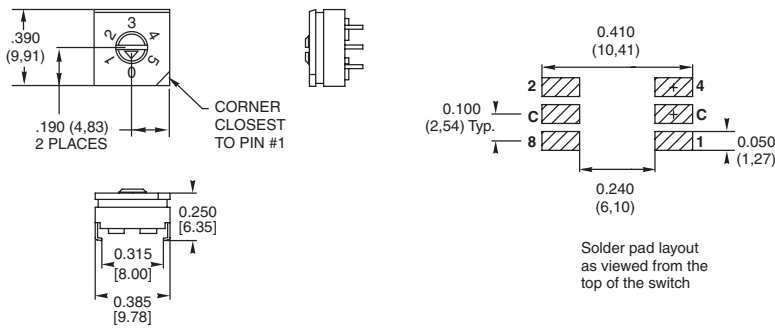

Standard Thru-Hole

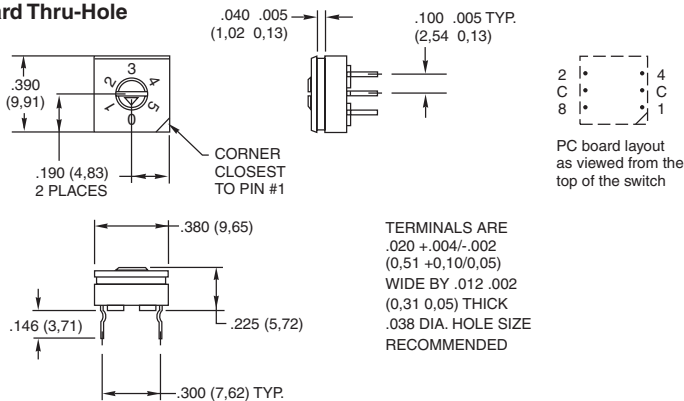

TERMINALS ARE
 $.020 + .004/-0.002$
(0,51 + 0,10/0,05)
WIDE BY $.012$.002
(0,31 0,05) THICK
.038 DIA. HOLE SIZE
RECOMMENDED

FEATURES

- Sealed Construction; No Tape Seal Required
- Surface Mount or Thru-Hole Style
- Tube or Tape and Reel Packaging
- Octal, BCD, and Hexadecimal Code
- In Standard or Complement
- Standard and Right Angle Mount
- Flush or Extended Actuators
- Gold-Plated Contacts
- RoHS Compliant

ACTUATOR STYLES



Octal-8 position



BCD-10 position



Hex-16 position



Figure 2
"F" style rotor

Figure 1
"A" style rotor

All actuation types are available in octal (8), binary coded decimal (10), or hexadecimal (16) codes; with either standard or complement output. Standard code outputs have natural color rotors; complements in a contrasting color.

EXTENDED ACTUATOR TYPES

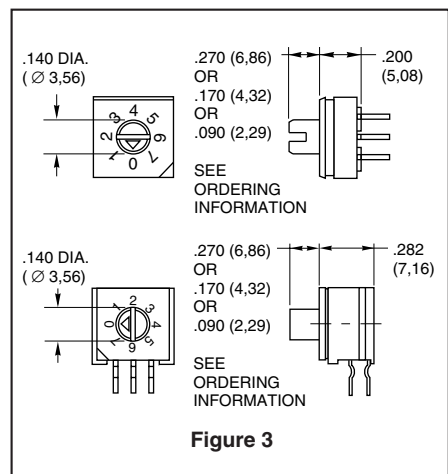
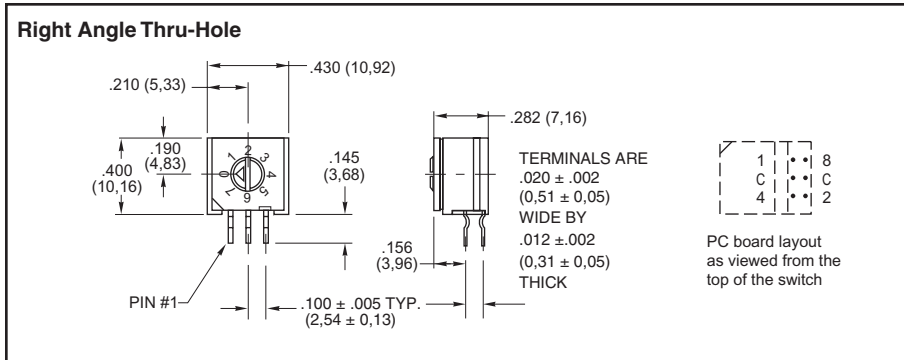

Figure 3



Rotary DIP Switches

DIMENSIONS in inches (and millimeters)



ORDERING INFORMATION: Series 94H

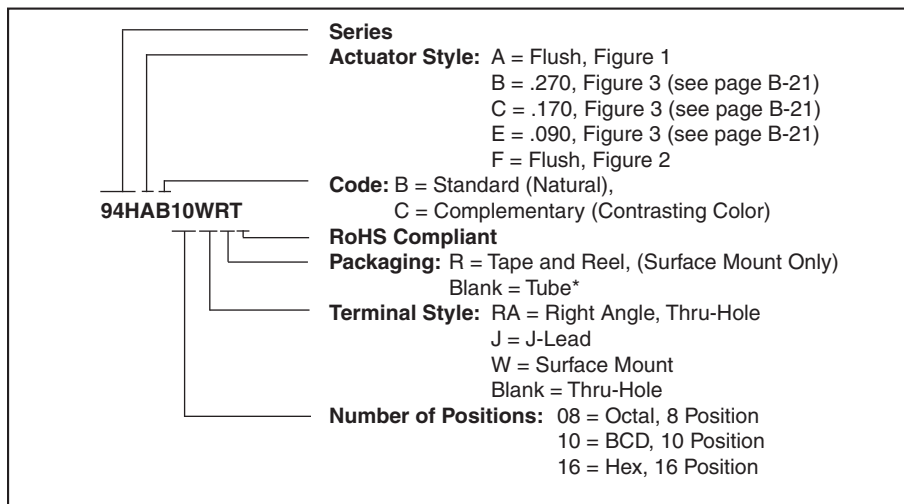

* 27 Pieces per tube for surface mount and thru-hole, 24 pieces per tube for right angle switches.

SERIES 94 High Temperature Knobs: For Shaft Extensions

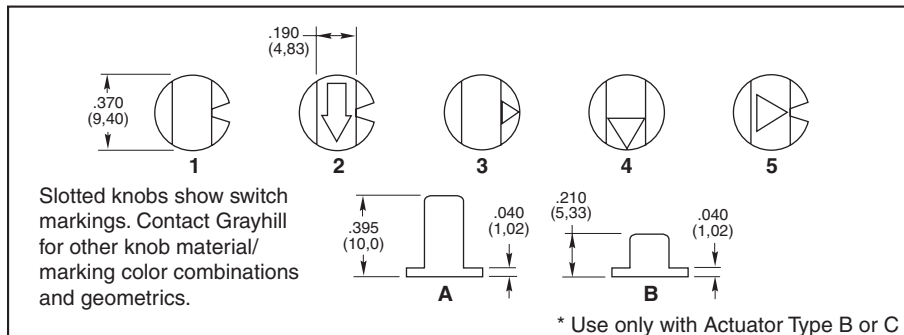

ORDERING INFORMATION: Series 94 High Temperature Knobs*

Knob Style and Height	Knob Color	Arrow Color	Part Number
1A	Gray	N/A	947706-001
5A	Gray	Black	947706-005
1B	Black	N/A	947705-001
1B	Gray	N/A	947705-012
2B	Gray	White	947705-004
3B	Gray	Black	947705-017
4B	Gray	Black	947705-018
1B	Natural	N/A	947705-009
4B	Black	White	947705-010
5B	Gray	Black	947705-019

*Ordered as a separate item. B = Standard (Natural), C = Complementary (Contrasting Color).

TAPE AND REEL PACKAGING: Series 94H

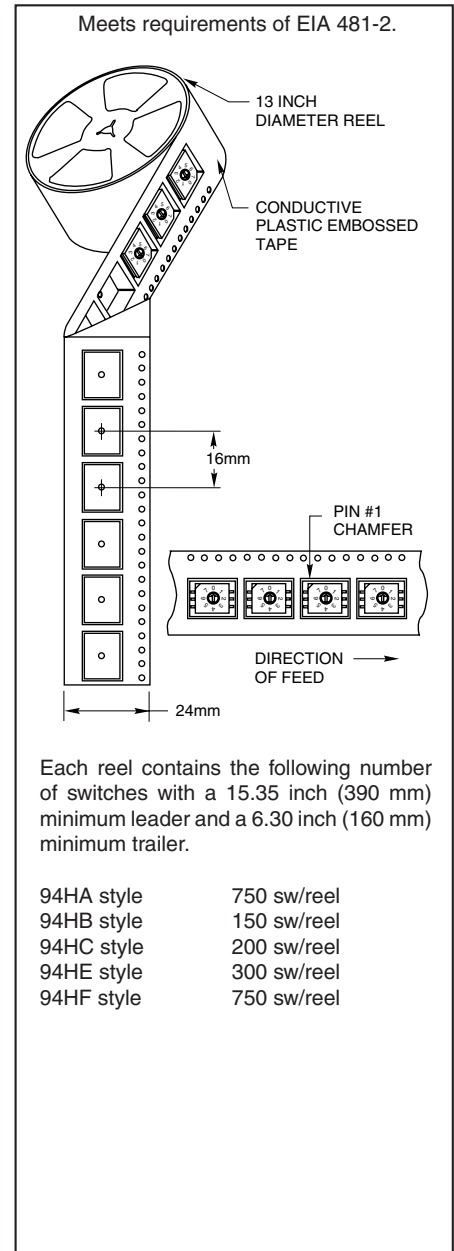

94HA style	750 sw/reel
94HB style	150 sw/reel
94HC style	200 sw/reel
94HE style	300 sw/reel
94HF style	750 sw/reel

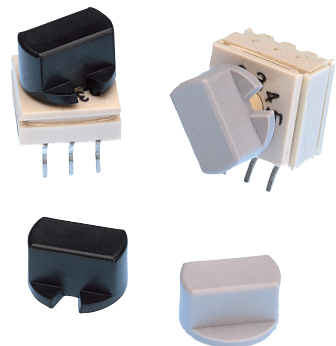

Available from your local Grayhill Distributor. For prices and discounts, contact a local Sales Office, an authorized Distributor or Grayhill.

SPECIFICATIONS

Electrical Ratings

Make-and-break Current Rating: 30 mA at 30 Vdc for 10,000 cycles of operation.

Carrying Current Rating: 100 mA at 50 Vdc

Contact Resistance: 50 mohms maximum initially (measured at 10 mA, 50 mVdc). 150 mohms maximum after life.

Insulation Resistance:(measured at 100 Vdc across open switch contacts)
Initial: 5000 Mohms minimum. After Life: 1000 Mohms minimum.

Dielectric Strength: (measured across open switch contacts) Initial: 500 Vac RMS minimum. After Life: 250 Vac RMS

Mechanical Ratings

Mechanical Life: 10,000 cycles of operation. One cycle is a rotation through all positions and a complete return through all positions.

Mechanical Shock: 1000g's, 0.5mS, half sine per MIL-STD-202F, Method 213, Test Condition E.

Vibration Resistance: 10-2000 Hz at 15G or 0.060" double amplitude per MIL-STD-202F, Method 204, Test Condition B.

Operational Torque: 2 to 6 inch-ounces initially and 1.2 inch-ounces minimum after life.

Environmental Ratings

Operating Temperature Range: -40° to +85°C.

Storage Temperature Range: -40° to +85°C.

Moisture Resistance: 240 hours with temperature cycling and polarization. Passes insulation resistance and dielectric strength per MIL-STD-202F, Method 106 following exposure.

Materials and Finishes

Rotor and Switch Body: Plastic (UL94V-O)

Contact Material: Copper alloy plated. 30 microinches minimum gold over 50 microinches minimum nickel.

Shorting Member: Copper alloy plated. 30 microinches minimum gold over 50 microinches minimum nickel.

Terminals: Copper alloy, matte tin plated over nickel barrier.

Internal O-ring: Rubber BUNA-N

Soldering Information

*For the most current soldering & cleaning processing guidelines, please see page 4

Soldering Temperature: 260° C maximum.
Cleaning: Acceptable solutions include 1-1-1 Trichlorethane, Freon (TF, TE, or TMS), Isopropyl Alcohol and detergent (140°F maximum). Solutions which are not recommended include Acetone, Methylene Chloride, and Freon TMC.

CODE & TRUTH TABLES

All switches are continuous rotation.

Dot indicates terminal to common connection.

Octal and Octal Complement outputs are 0 thru 7 positions.

BCD and BCD Complement outputs are 0 thru 9 positions.

Hexadecimal and Hexadecimal Complement outputs are 0 thru F positions.

Standard codes have natural color rotors. Complements have rotors in a contrasting color.

SWITCH POSITION	Standard Output				Complement Output			
	CODE OUTPUT				CODE OUTPUT			
	1	2	4	8	1	2	4	8
0					●	●	●	●
1	●					●	●	●
2		●			●		●	●
3	●	●					●	●
4			●		●	●		●
5	●		●			●		●
6		●	●		●			●
7	●	●	●					●
8				●	●	●	●	
9	●			●		●	●	
A		●	●		●	●		
B	●	●	●				●	
C			●	●	●	●		
D	●		●	●		●		
E		●	●	●	●			
F	●	●	●	●				



Grayhill DIP Switch Processing Information

The information provided within is intended as processing guidelines for the assembly, soldering, cleaning, and use of Grayhill DIP switches. This information supersedes any other process information that is available in Grayhill Inc. catalogs or data sheets as related to Grayhill Inc. standard DIP switch products. Please contact Grayhill Inc. for any questions related to the information in this document.

Mounting

Unless otherwise noted, Grayhill DIP switches are shipped with slides or rockers in the ON position and rotary DIP switches are shipped with the actuators in the 0 position. It is recommended that they be solder processed in those positions to ensure proper performance without issue.

Soldering

WAVE SOLDER: Switches that can be processed using wave solder equipment (thru hole soldering) are as follows:

Grayhill Series 76SB, 76PSB, 76PSB, 76RSB, 76SC, 76RSC, 76RSD, 76SD, 76STC, 76STD, 78B, 78RB, 78F, 78G, 78H, 78J, 78K, 90B, 94H (thru hole models), and 94R

Wave soldering guidelines: Solder wave temperature is 260°C. max. for 5 seconds max. (0.063" thick PCB). Exposure to flux should be kept to a minimum.

Manual soldering guidelines (for thru hole switches): Soldering temperature is 350C for soldering iron tip with 3 seconds maximum of dwell time.

REFLOW SOLDER: Switches that can be processed using reflow process equipment are as follows:

Grayhill Series 76HP, 78HF, 78HJ, 90B, 90HB, 94H, 94R, 97C, and 97R

Reflow soldering guidelines: Soldering temperature is 260C max. for 5 seconds, with a maximum of two reflow cycles at the maximum conditions. Switches should be allowed to cool for 3 to 5 minutes between reflow cycles. Reflow soldering should not be done to any Grayhill DIP switch products not listed directly above as the exposure to higher surface temperatures could cause permanent deformation of the plastic materials.

Recommended Maximum Soldering Conditions:

Reflow Soldering Profile:
(260°C Peak Temperature)

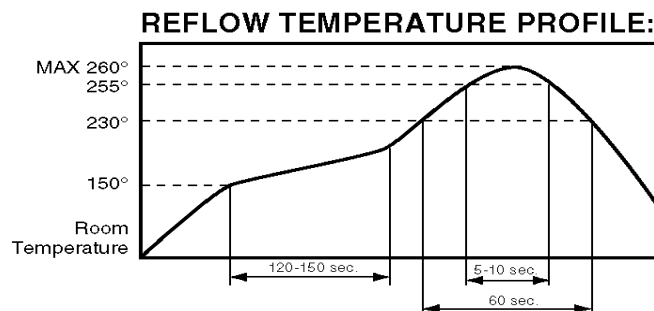

PCB Cleaning

In-line DIP switches that are tape sealed can be processed using certain washing processes as described below. Tape sealed switches can typically be identified by a suffix of ST or PT that follows after the series, switch style, and number of position identifiers (i.e., 76SB08ST). Non-tape sealed switches should not be subjected to any washing processes as they can introduce contaminants into the contact area of the switches. Rotary DIP products (94H & 94R) are internally sealed and can be processed the same as tape sealed products.

Tape sealed and rotary DIP switch products are qualified for immersion cleaning processes using alcohol or detergent based cleaning solvents at temperatures up to 140°F. maximum. Tape seal products must have the tape seal undisturbed until after any cleaning process. Cleaning processes that use ultrasonic agitation or that use pressurized sprays can defeat the tape and / or internal seals and allow contamination of the switches. They are not recommended for use on inline or rotary DIP products. Switches should not be washed directly after a soldering process. There should be a delay of at least three minutes to allow adequate time for cooling after soldering.

Tape seal integrity: Inline DIP products that are tape sealed are tested to meet and pass a gross leak test using 125°C Fluorinert for 20 seconds minimum. Reference MIL-202, Method 112.

Tape seal material:

76,78: Polyester film, rated to 170°F. maximum temperature

90: Polyimide film, rated to 260°C. maximum temperature

X-ON Electronics

Largest Supplier of Electrical and Electronic Components

Click to view similar products for [Knobs & Dials](#) category:

Click to view products by [Grayhill](#) manufacturer:

Other Similar products are found below :

[790-1030](#) [790-1202](#) [790-2226](#) [8519](#) [8529](#) [8547](#) [85-559](#) [8573](#) [11K5015-EMNB](#) [11K5019-ECNB](#) [11K5020-KLAB](#) [11K5048-KMNB](#)
[11K5014-EMNB](#) [11K5015-EMNG](#) [11K5019-EMNB](#) [MS91528-2N2B](#) [1770](#) [P400S-08-D6-N](#) [K6510](#) [KNP700A1/4](#) [3045B](#) [AR22PY-122B](#)
[PKJ50B18](#) [277A](#) [348003](#) [42000B38](#) [420114B14](#) [5006](#) [56008-001](#) [KS700B14](#) [411](#) [420037B14](#) [WA-101C-P](#) [WA-102B](#) [WA-103](#) [WA-109B](#)
[WA-1450-P](#) [WA-1550](#) [WA-1600-P](#) [WA-2300](#) [WA-4100](#) [WA-4108-P](#) [0166736-006](#) [0195316-052](#) [0703006-003](#) [0744386-211](#) [52-928.20](#)
[52-928.9](#) [8517](#) [8545](#)