

### Feature

- International standard package
- Low forward voltage drop
- Isolation voltage 2500V~

### Application

- DC power suppliers for apparatus device
- Input rectifying power supply for PWM converters
- Inverter welders

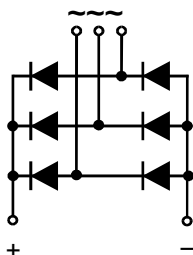

### Maximum value

Symbol	Parameter	Rating							Unit
		MDS300-06F	MDS300-08F	MDS300-10F	MDS300-12F	MDS300-14F	MDS300-16F	MDS300-18F	
$V_{RRM}$	Peak reverse repetitive voltage	600	800	1000	1200	1400	1600	1800	V
$V_{RSM}$	Peak reverse non-repetitive voltage	700	900	1100	1300	1500	1700	1900	V

Symbol	Parameter	Test condition	Rating	Unit
$I_o$	Output DC current	Three-phase whole wave rectifying circuit $T_c:100^\circ\text{C}$	300	A
$I_{FSM}$	Forward surge current	$t=10\text{ms}, 50\text{HZ}, \text{sin}, T_{jm}$	4800	A
$I^2t$	$I^2t$ value	$V_R = 0.6V_{RRM}, T_{jm}$	115200	$\text{A}^2\text{S}$
$V_{ISO}$	Isolation voltage	AC one min	2500	V
$T_j$	Operating junction temperature		-40 to +150	$^\circ\text{C}$
$T_{jm}$	Rated junction temperature		150	$^\circ\text{C}$
$T_{stg}$	Storage temperature		-40 to +125	$^\circ\text{C}$
$M_d$	Mounting torque (copper plate) M6		5±15%	N·m
	Mounting torque (terminal) <small>M6 M8</small>		5±15% 7±15%	N·m
$W_t$	weight		580	g

### Electrical characteristics

Symbol	Parameter	Test condition	Rating	Unit
$I_{RRM}$	Peak reverse repetitive current	Single-side heat dissipation, $V_R=V_{RRM}$ , sine half wave, $T_j=150^\circ\text{C}$	10	mA
$V_{FM}$	Peak forward voltage	$I_{FM}=400\text{A}, T_j=25^\circ\text{C}$	1.1	V
$R_{th(j-c)}$	Thermal impedance (junction-case)	Single-side heat dissipation, sine half wave	0.16	$^\circ\text{C/W}$

### Performance Curves

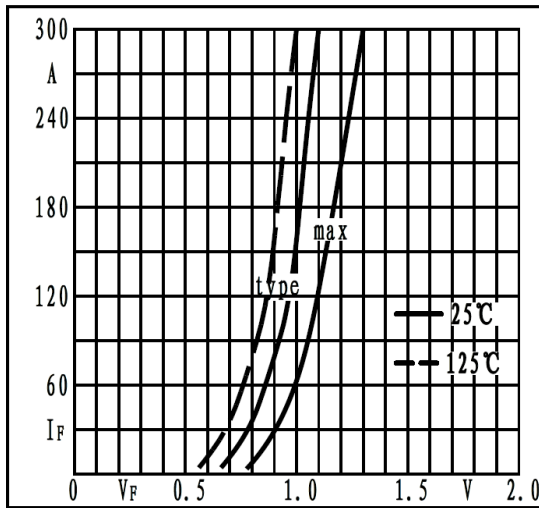

Fig1. Forward characteristics

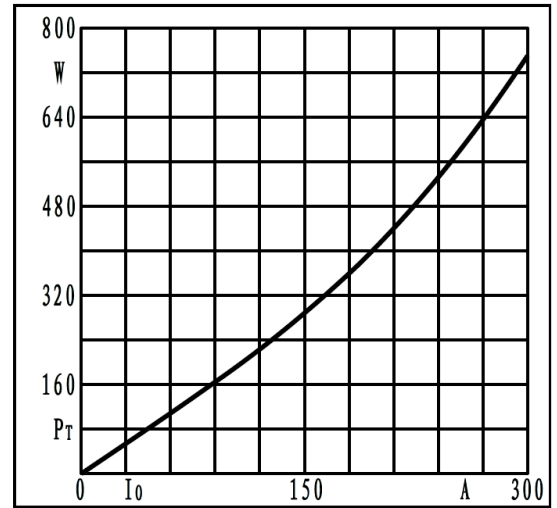

Fig2. Power dissipation

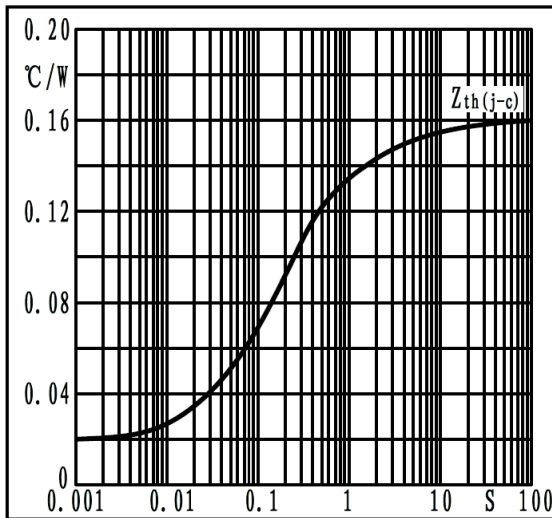

Fig3. Transient thermal impedance

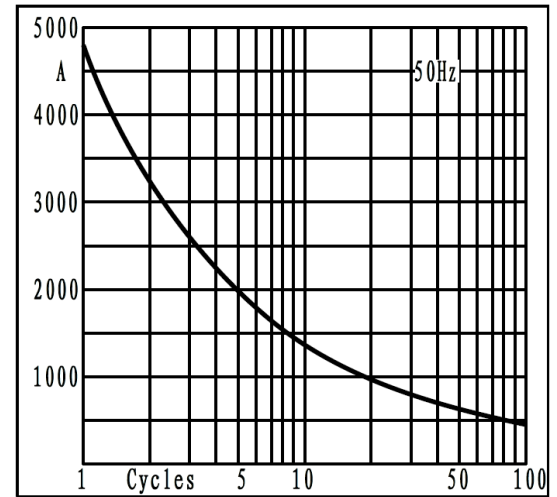

Fig4. Max non-repetitive forward surge current

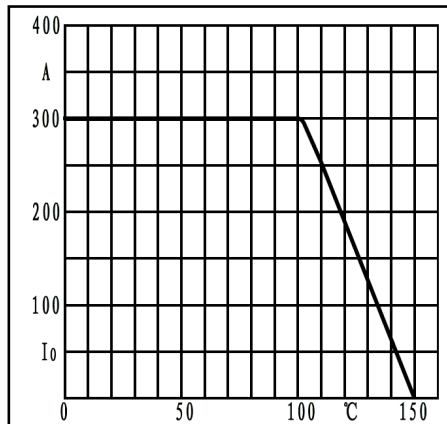
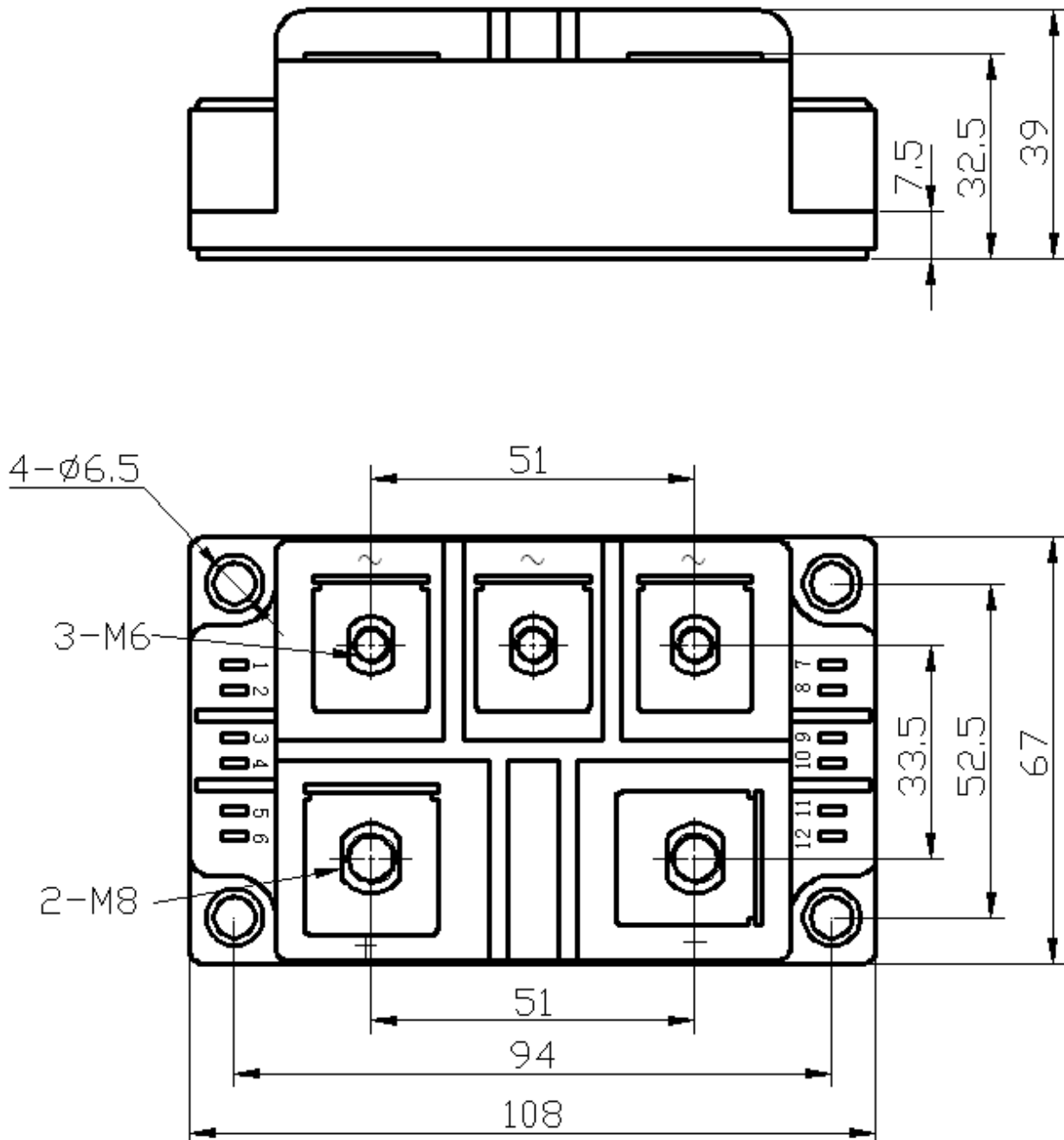

Fig5. Forward current derating curve

### Dimension



## X-ON Electronics

Largest Supplier of Electrical and Electronic Components

*Click to view similar products for [Bridge Rectifiers](#) category:*

*Click to view products by [GREGOO](#) manufacturer:*

Other Similar products are found below :

[MB2510](#) [MB252](#) [MB356G](#) [MB358G](#) [MP358-BP](#) [GBJ1504-BP](#) [GBU15J-BP](#) [GBU15K-BP](#) [GBU4A-BP](#) [GBU4D-BP](#) [GBU6B-E3/45](#)  
[GSIB680-E3/45](#) [DB101-BP](#) [DF01](#) [DF10SA-E345](#) [BU1508-E3/45](#) [KBPC50-10S](#) [RS405GL-BP](#) [G5SBA60-E3/51](#) [GBJ1502-BP](#) [GBU10J-BP](#)  
[GBU4J-BP](#) [GBU6M](#) [GBU8D-BP](#) [GBU8J-BP](#) [GSIB1520-E3/45](#) [2KBB10](#) [36MB140A](#) [TB102M](#) [MB1510](#) [MB258](#) [MB6M-G](#) [MB86](#)  
[TL401G](#) [MDA920A2](#) [TU602](#) [TU810](#) [BR1005-BP](#) [BR101-BP](#) [BR84DTP204](#) [BU2008-E3/51](#) [36MB100A](#) [36MT160](#) [36MT60](#) [KBPC25-02](#)  
[VS-2KBB60](#) [DBB08G-TM-E](#) [DBD250G](#) [DBF20G](#) [DF06SA-E345](#)