

100-Pin TQFP  
Commercial Temp  
Industrial Temp

## 4Mb Pipelined and Flow Through Synchronous NBT SRAMs

250 MHz–100 MHz  
3.3 V  $V_{DD}$   
2.5 V and 3.3 V  $V_{DDQ}$

### Features

- 256K x 18 and 128K x 36 configurations
- User configurable Pipeline and Flow Through mode
- NBT (No Bus Turn Around) functionality allows zero wait read-write-read bus utilization
- Fully pin compatible with both pipelined and flow through NtRAM™, NoBL™ and ZBT™ SRAMs
- Pin-compatible with 2Mb, 9Mb and 18Mb devices
- 3.3 V +10%/–5% core power supply
- 2.5 V or 3.3 V I/O supply
- $\overline{LBO}$  pin for Linear or Interleave Burst mode
- Byte write operation (9-bit Bytes)
- 3 chip enable signals for easy depth expansion
- Clock Control, registered address, data, and control
- ZZ Pin for automatic power-down
- RoHS-compliant 100-lead TQFP package

### Functional Description

The GS840Z18/36CGT is a 4Mbit Synchronous Static SRAM. GSI's NBT SRAMs, like ZBT, NtRAM, NoBL or other pipelined read/double late write or flow through read/single late write SRAMs, allow utilization of all available bus bandwidth by eliminating the need to insert deselect cycles when the device is switched from read to write cycles.

Because it is a synchronous device, address, data inputs, and read/write control inputs are captured on the rising edge of the input clock. Burst order control ( $\overline{LBO}$ ) must be tied to a power rail for proper operation. Asynchronous inputs include the sleep mode enable (ZZ) and Output Enable. Output Enable can be used to override the synchronous control of the output drivers and turn the RAM's output drivers off at any time. Write cycles are internally self-timed and initiated by the rising edge of the clock input. This feature eliminates complex off-chip write pulse generation required by asynchronous SRAMs and simplifies input signal timing.

The GS840Z18/36CGT may be configured by the user to operate in Pipeline or Flow Through mode. Operating as a pipelined synchronous device, in addition to the rising-edge-triggered registers that capture input signals, the device incorporates a rising-edge-triggered output register. For read cycles, pipelined SRAM output data is temporarily stored by the edge triggered output register during the access cycle and then released to the output drivers at the next rising edge of clock.

The GS840Z18/36CGT is implemented with GSI's high performance CMOS technology and is available in a 6/6 RoHS-compliant, JEDEC-standard 100-pin TQFP package.

### Parameter Synopsis

		-250	-200	-166	-150	-100
Pipeline 3-1-1-1	tCycle	4.0 ns	5.5 ns	6.0 ns	6.7 ns	10 ns
	tKO	2.5 ns	3.0 ns	3.5 ns	3.8 ns	4.5 ns
	I <sub>DD</sub>	TBD	TBD	TBD	TBD	TBD
Flow Through 2-1-1-1	tKO	5.5 ns	6.5 ns	7.0 ns	7.5 ns	12 ns
	tCycle	5.5 ns	6.5 ns	7.0 ns	7.5 ns	12 ns
	I <sub>DD</sub>	TBD	TBD	TBD	TBD	TBD



GS840Z36CGT Pinout (Package T)

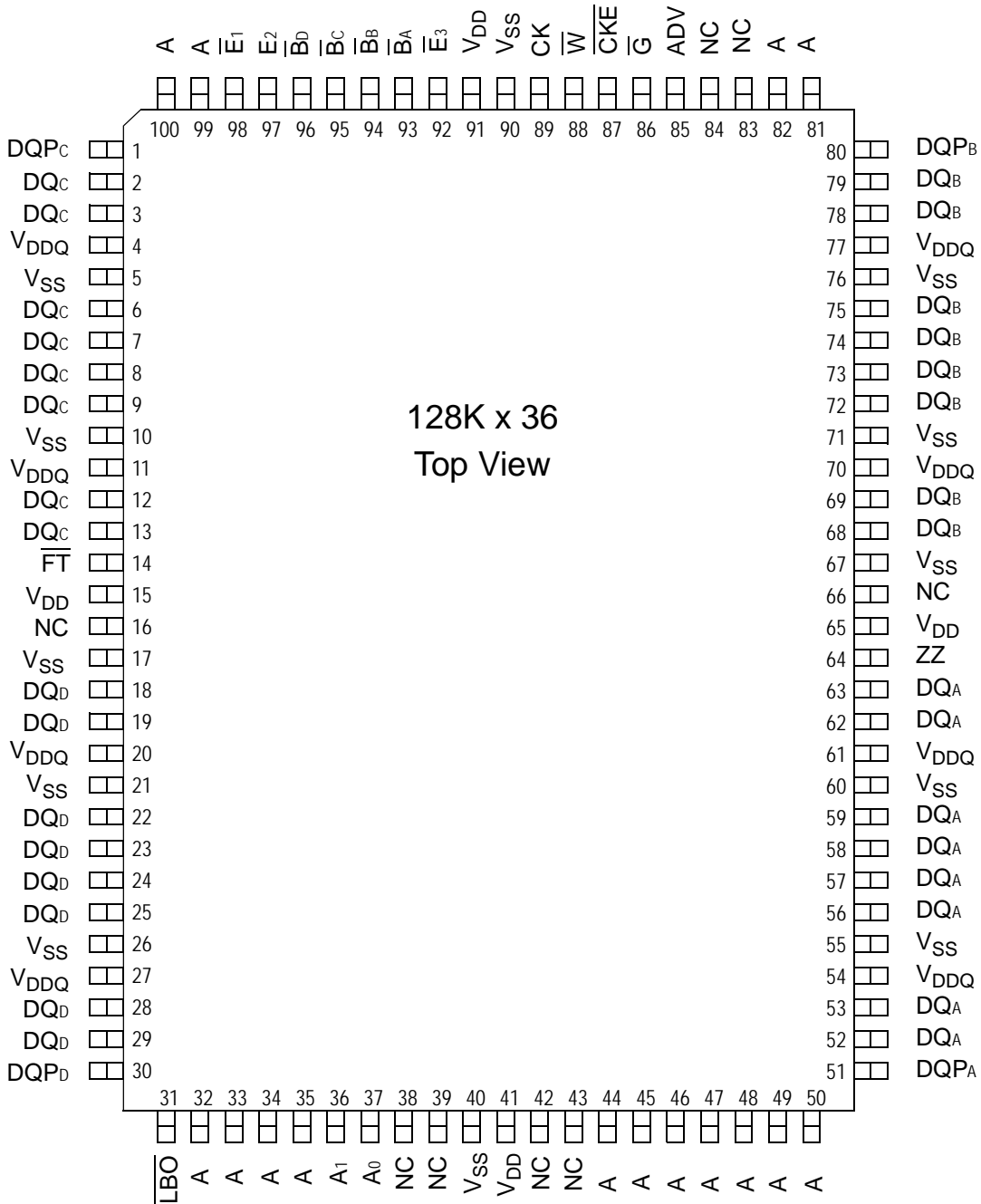

**Note:**

Pins marked with NC can be tied to either VDD or VSS. These pins can also be left floating.

## 100-Pin TQFP Pin Descriptions

Symbol	Type	Description
A0, A1	In	Burst Address Inputs; preload the burst counter
A	In	Address Inputs
CK	In	Clock Input Signal
$\overline{BA}$	In	Byte Write signal for data inputs DQA1-DQA9; active low
$\overline{BB}$	In	Byte Write signal for data inputs DQB1-DQB9; active low
$\overline{BC}$	In	Byte Write signal for data inputs DQC1-DQC9; active low
$\overline{BD}$	In	Byte Write signal for data inputs DQD1-DQD9; active low
$\overline{W}$	In	Write Enable; active low
$\overline{E1}$	In	Chip Enable; active low
E2	In	Chip Enable; active high; for self decoded depth expansion
$\overline{E3}$	In	Chip Enable; active low, for self decoded depth expansion
$\overline{G}$	In	Output Enable; active low
ADV	In	Advance / $\overline{Load}$ —Burst address counter control pin
$\overline{CKE}$	In	Clock Input Buffer Enable; active low
DQA	I/O	Byte A Data Input and Output pins
DQB	I/O	Byte B Data Input and Output pins
DQC	I/O	Byte C Data Input and Output pins
DQD	I/O	Byte D Data Input and Output pins
ZZ	In	Power down control; active high
$\overline{FT}$	In	Pipeline/Flow Through Mode Control; active low
$\overline{LBO}$	In	Linear Burst Order; active low
V <sub>DD</sub>	In	3.3 V power supply
V <sub>SS</sub>	In	Ground
V <sub>DDQ</sub>	In	3.3 V output power supply for noise reduction
NC	—	No Connect

GS840Z18/36C NBT SRAM Functional Block Diagram

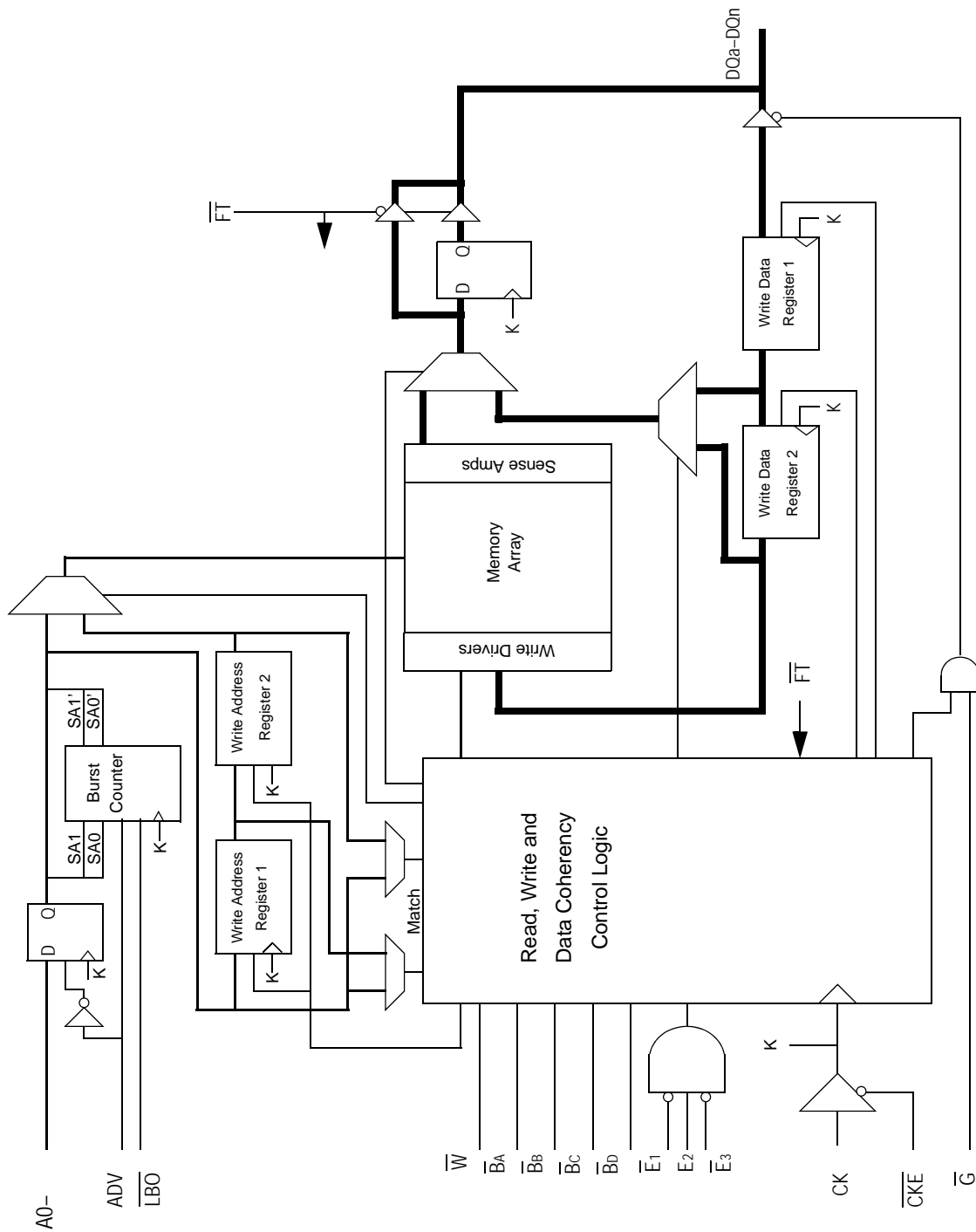

## Functional Details

### Clocking

Deassertion of the Clock Enable ( $\overline{\text{CKE}}$ ) input blocks the Clock input from reaching the RAM's internal circuits. It may be used to suspend RAM operations. Failure to observe Clock Enable set-up or hold requirements will result in erratic operation.

### Pipelined Mode Read and Write Operations

All inputs (with the exception of Output Enable, Linear Burst Order and Sleep) are synchronized to rising clock edges. Single cycle read and write operations must be initiated with the Advance/Load pin (ADV) held low, in order to load the new address. Device activation is accomplished by asserting all three of the Chip Enable inputs ( $\overline{\text{E}}_1$ ,  $\text{E}_2$ , and  $\overline{\text{E}}_3$ ). Deassertion of any one of the Enable inputs will deactivate the device.

Function	$\overline{\text{W}}$	$\overline{\text{B}}_A$	$\overline{\text{B}}_B$	$\overline{\text{B}}_C$	$\overline{\text{B}}_D$
Read	H	X	X	X	X
Write Byte "a"	L	L	H	H	H
Write Byte "b"	L	H	L	H	H
Write Byte "c"	L	H	H	L	H
Write Byte "d"	L	H	H	H	L
Write all Bytes	L	L	L	L	L
Write Abort/NOP	L	H	H	H	H

Read operation is initiated when the following conditions are satisfied at the rising edge of clock:  $\overline{\text{CKE}}$  is asserted low, all three chip enables ( $\overline{\text{E}}_1$ ,  $\text{E}_2$ , and  $\overline{\text{E}}_3$ ) are active, the write enable input signal  $\overline{\text{W}}$  is deasserted high, and ADV is asserted low. The address presented to the address inputs is latched in to address register and presented to the memory core and control logic. The control logic determines that a read access is in progress and allows the requested data to propagate to the input of the output register. At the next rising edge of clock the read data is allowed to propagate through the output register and onto the Output pins.

Write operation occurs when the RAM is selected, CKE is active and the write input is sampled low at the rising edge of clock. The Byte Write Enable inputs ( $\overline{\text{B}}_A$ ,  $\overline{\text{B}}_B$ ,  $\overline{\text{B}}_C$ , and  $\overline{\text{B}}_D$ ) determine which bytes will be written. All or none may be activated. A write cycle with no Byte Write inputs active is a no-op cycle. The Pipelined NBT SRAM provides double late write functionality, matching the write command versus data pipeline length (2 cycles) to the read command versus data pipeline length (2 cycles). At the first rising edge of clock, Enable, Write, Byte Write(s), and Address are registered. The Data In associated with that address is required at the third rising edge of clock.

### Flow through Mode Read and Write Operations

Operation of the RAM in Flow Through mode is very similar to operations in Pipeline mode. Activation of a read cycle and the use of the Burst Address Counter is identical. In Flow Through mode the device may begin driving out new data immediately after new address are clocked into the RAM, rather than holding new data until the following (second) clock edge. Therefore, in Flow Through mode the read pipeline is one cycle shorter than in Pipeline mode.

Write operations are initiated in the same way as well, but differ in that the write pipeline is one cycle shorter as well, preserving the ability to turn the bus from reads to writes without inserting any dead cycles. While the pipelined NBT RAMs implement a double late write protocol, in Flow Through mode a single late write protocol mode is observed. Therefore, in Flow Through mode, address and control are registered on the first rising edge of clock and data in is required at the data input pins at the second rising edge of clock.

## Synchronous Truth Table

Operation	Type	Address	CK	$\overline{\text{CKE}}$	ADV	$\overline{\text{W}}$	$\overline{\text{Bx}}$	$\overline{\text{E1}}$	E2	$\overline{\text{E3}}$	$\overline{\text{G}}$	ZZ	DQ	Notes
Read Cycle, Begin Burst	R	External	L-H	L	L	H	X	L	H	L	L	L	Q	
Read Cycle, Continue Burst	B	Next	L-H	L	H	X	X	X	X	X	L	L	Q	1,10
NOP/Read, Begin Burst	R	External	L-H	L	L	H	X	L	H	L	H	L	High-Z	2
Dummy Read, Continue Burst	B	Next	L-H	L	H	X	X	X	X	X	H	L	High-Z	1,2,10
Write Cycle, Begin Burst	W	External	L-H	L	L	L	L	L	H	L	X	L	D	3
Write Abort, Begin Burst	D	None	L-H	L	L	L	H	L	H	L	X	L	High-Z	1
Write Cycle, Continue Burst	B	Next	L-H	L	H	X	L	X	X	X	X	L	D	1,3,10
Write Abort, Continue Burst	B	Next	L-H	L	H	X	H	X	X	X	X	L	High-Z	1,2,3,10
Deselect Cycle, Power Down	D	None	L-H	L	L	X	X	H	X	X	X	L	High-Z	
Deselect Cycle, Power Down	D	None	L-H	L	L	X	X	X	X	H	X	L	High-Z	
Deselect Cycle, Power Down	D	None	L-H	L	L	X	X	X	L	X	X	L	High-Z	
Deselect Cycle, Continue	D	None	L-H	L	H	X	X	X	X	X	X	L	High-Z	1
Sleep Mode		None	X	X	X	X	X	X	X	X	X	H	High-Z	
Clock Edge Ignore, Stall		Current	L-H	H	X	X	X	X	X	X	X	L	-	4

## Notes:

- Continue Burst cycles, whether read or write, use the same control inputs. A Deselect continue cycle can only be entered into if a Deselect cycle is executed first.
- Dummy Read and Write abort can be considered NOPs because the SRAM performs no operation. A Write abort occurs when the  $\overline{\text{W}}$  pin is sampled low but no Byte Write pins are active so no write operation is performed.
- $\overline{\text{G}}$  can be wired low to minimize the number of control signals provided to the SRAM. Output drivers will automatically turn off during write cycles.
- If  $\overline{\text{CKE}}$  High occurs during a pipelined read cycle, the DQ bus will remain active (Low Z). If  $\overline{\text{CKE}}$  High occurs during a write cycle, the bus will remain in High Z.
- X = Don't Care; H = Logic High; L = Logic Low;  $\overline{\text{Bx}}$  = High = All Byte Write signals are high;  $\overline{\text{Bx}}$  = Low = One or more Byte/Write signals are Low
- All inputs, except  $\overline{\text{G}}$  and ZZ must meet setup and hold times of rising clock edge.
- Wait states can be inserted by setting  $\overline{\text{CKE}}$  high.
- This device contains circuitry that ensures all outputs are in High Z during power-up.
- A 2-bit burst counter is incorporated.
- The address counter is incremented for all Burst continue cycles.

## Pipelined and Flow Through Read-Write Control State Diagram

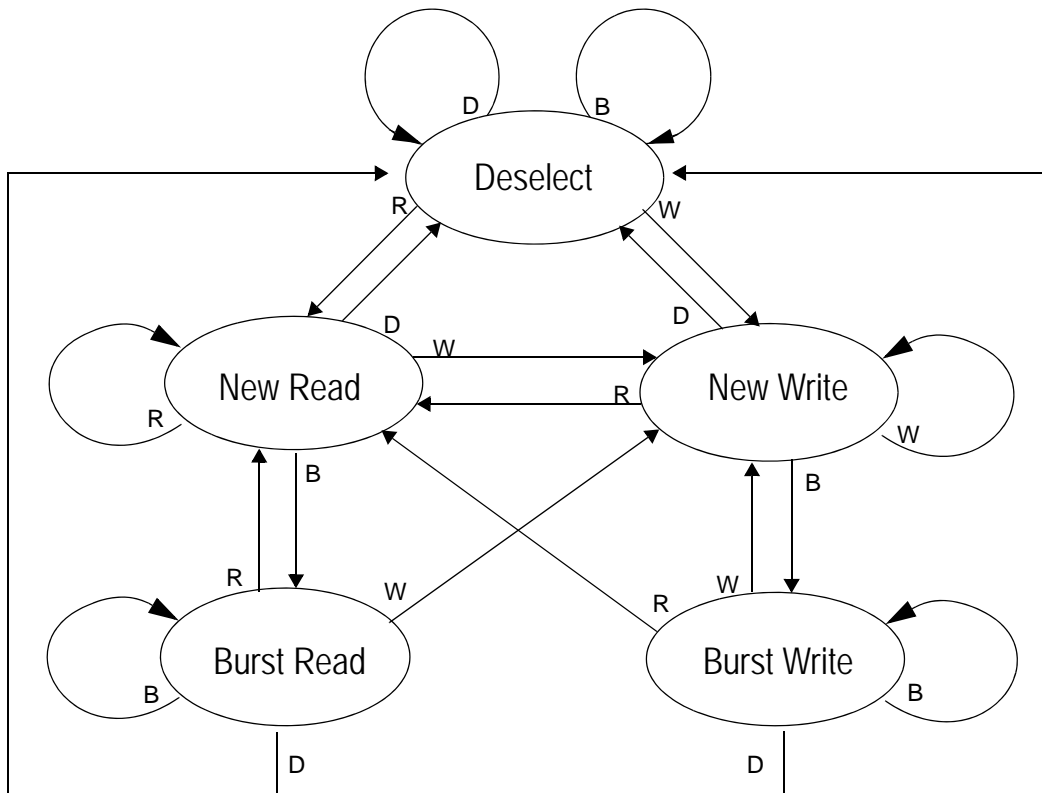
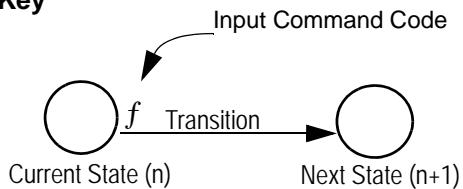
**Key**

**Notes**

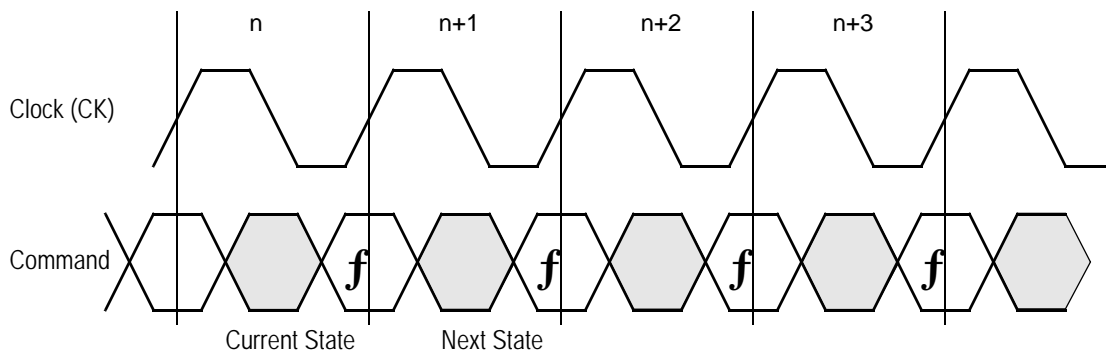
1. The Hold command ( $\overline{\text{CKE}}$  Low) is not shown because it prevents any state change.
2. W, R, B, and D represent input command codes as indicated in the Synchronous Truth Table.



## Current State and Next State Definition for Pipelined and Flow Through Read/Write Control State Diagram



Pipeline Mode Data I/O State Diagram

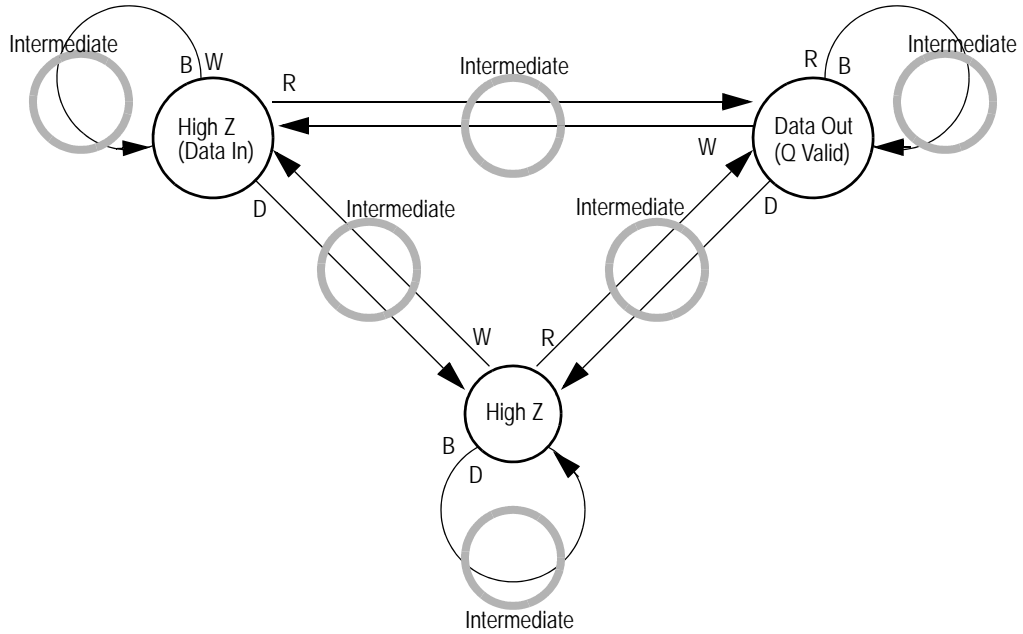

Key

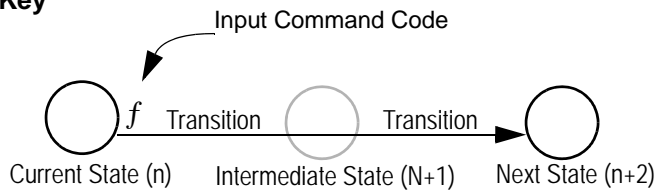

Notes

1. The Hold command ( $\overline{CKE}$  Low) is not shown because it prevents any state change.
2. W, R, B, and D represent input command codes as indicated in the Truth Tables.

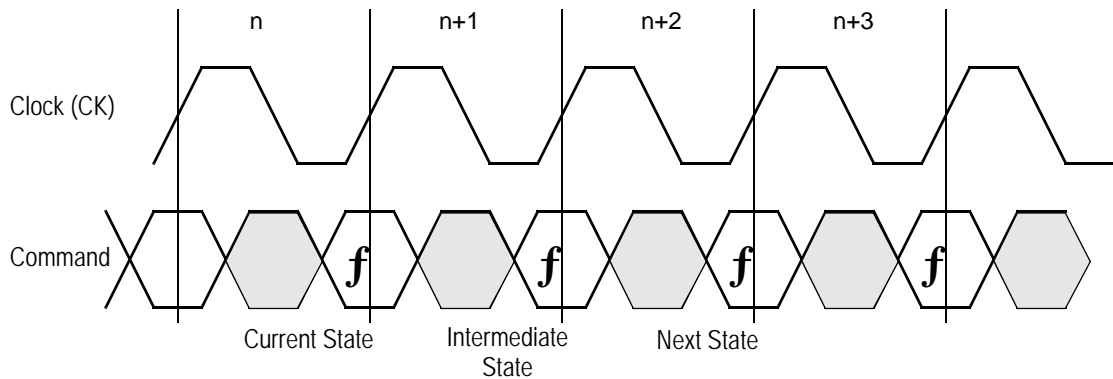

Current State and Next State Definition for Pipeline Mode Data I/O State Diagram

Flow Through Mode Data I/O State Diagram

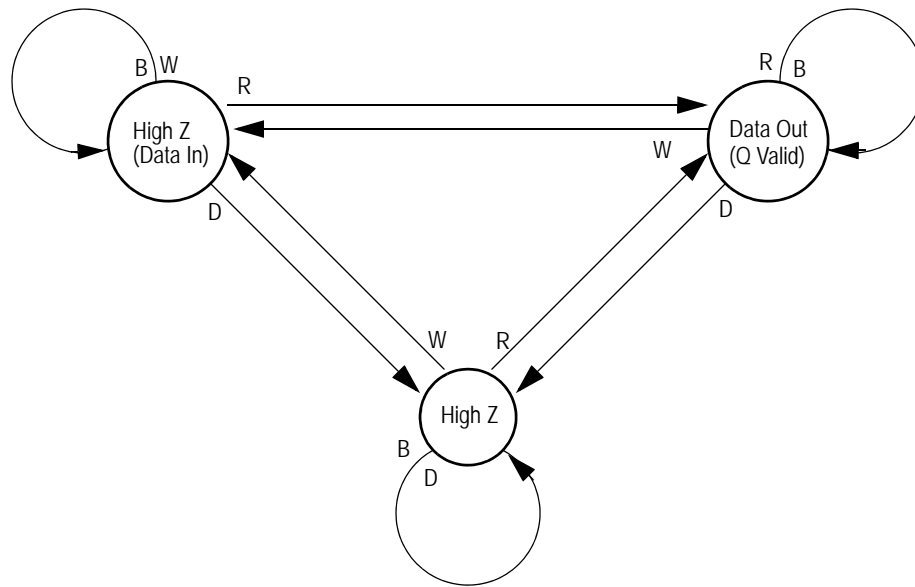

**Key**

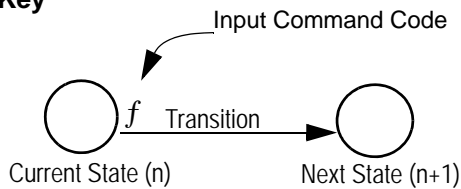

**Notes**

1. The Hold command ( $\overline{\text{CKE}}$  Low) is not shown because it prevents any state change.
2. W, R, B, and D represent input command codes as indicated in the Truth Tables.

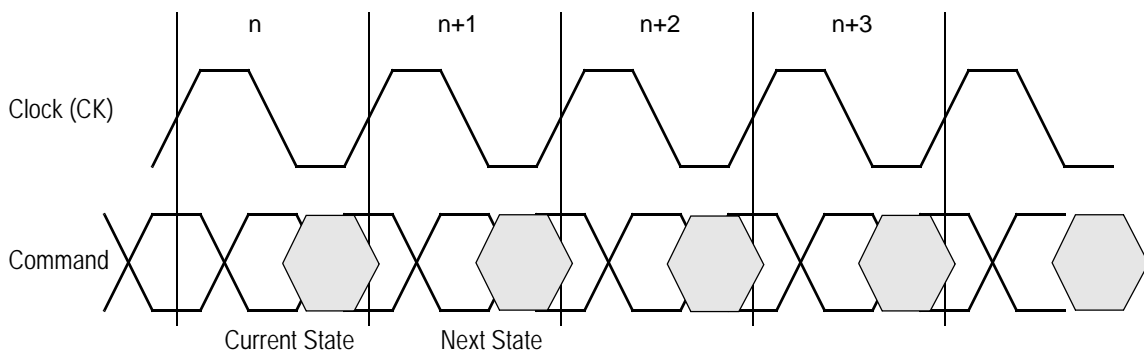

### Burst Cycles

Although NBT RAMs are designed to sustain 100% bus bandwidth by eliminating turnaround cycle when there is transition from Read to Write, multiple back-to-back reads or writes may also be performed. NBT SRAMs provide an on-chip burst address generator that can be utilized, if desired, to further simplify burst read or write implementations. The ADV control pin, when driven high, commands the SRAM to advance the internal address counter and use the counter generated address to read or write the SRAM. The starting address for the first cycle in a burst cycle series is loaded into the SRAM by driving the ADV pin low, into Load mode.

### Burst Order

The burst address counter wraps around to its initial state after four addresses (the loaded address and three more) have been accessed. The burst sequence is determined by the state of the Linear Burst Order pin ( $\overline{\text{LBO}}$ ). When this pin is low, a linear burst sequence is selected. When the RAM is installed with the LBO pin tied high, interleaved burst sequence is selected. See the tables below for details.

### Mode Pin Functions

Mode Name	Pin Name	State	Function
Burst Order Control	$\overline{\text{LBO}}$	L	Linear Burst
		H	Interleaved Burst
Output Register Control	$\overline{\text{FT}}$	L	Flow Through
		H or NC	Pipeline
Power Down Control	ZZ	L or NC	Active
		H	Standby, $I_{DD} = I_{SB}$

#### Note:

There is a pull-up device on the  $\overline{\text{FT}}$  pin and a pull-down device on the ZZ pin, so this input pin can be unconnected and the chip will operate in the default states as specified in the above tables.

### Burst Counter Sequences

#### Linear Burst Sequence

	A[1:0]	A[1:0]	A[1:0]	A[1:0]
1st address	00	01	10	11
2nd address	01	10	11	00
3rd address	10	11	00	01
4th address	11	00	01	10

#### Note:

The burst counter wraps to initial state on the 5th clock.

#### Interleaved Burst Sequence

	A[1:0]	A[1:0]	A[1:0]	A[1:0]
1st address	00	01	10	11
2nd address	01	00	11	10
3rd address	10	11	00	01
4th address	11	10	01	00

#### Note:

The burst counter wraps to initial state on the 5th clock.

### Sleep Mode

During normal operation, ZZ must be pulled low, either by the user or by its internal pull-down resistor. When ZZ is pulled high, the SRAM will enter a Power Sleep mode after 2 cycles. At this time, internal state of the SRAM is preserved. When ZZ returns to low, the SRAM operates normally after 2 cycles of wake up time.

Sleep mode is a low current, power-down mode in which the device is deselected and current is reduced to  $I_{SB2}$ . The duration of Sleep Mode is dictated by the length of time the ZZ is in a high state. After entering Sleep mode, all inputs except ZZ become disabled and all outputs go to High-Z. The ZZ pin is an asynchronous, active high input that causes the device to enter Sleep mode. When the ZZ pin is driven high,  $I_{SB2}$  is guaranteed after the time  $t_{ZZI}$  is met. Because ZZ is an asynchronous input, pending operations or operations in progress may not be properly completed if ZZ is asserted. Therefore, Sleep mode must not be initiated until valid pending operations are completed. Similarly, when exiting Sleep mode during  $t_{ZZR}$ , only a Deselect or Read commands may be applied while the SRAM is recovering from Sleep mode.

### Sleep Mode Timing Diagram

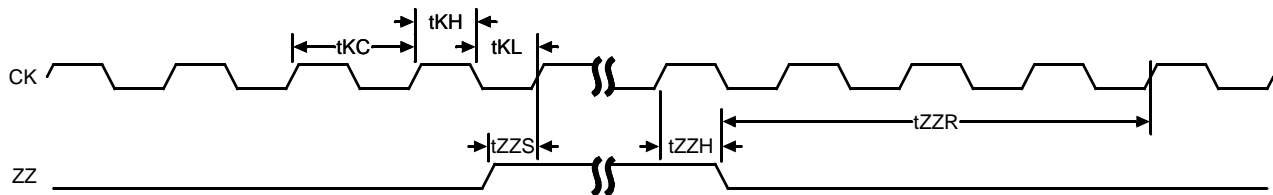

### Designing for Compatibility

The GSI NBT SRAMs offer users a configurable selection between Flow Through mode and Pipeline mode via the  $\overline{FT}$  signal found on Pin 14. Not all vendors offer this option, however, most mark Pin 14 as  $V_{DD}$  or  $V_{DDQ}$  on pipelined parts and  $V_{SS}$  on flow through parts. GSI NBT SRAMs are fully compatible with these sockets.

Pin 66, a No Connect (NC) on GSI's GS840Z18/36 NBT SRAM, the Parity Error open drain output on GSI's GS881Z18/36 NBT SRAM, is often marked as a power pin on other vendor's NBT-compatible SRAMs. Specifically, it is marked  $V_{DD}$  or  $V_{DDQ}$  on pipelined parts and  $V_{SS}$  on flow through parts. Users of GSI NBT devices who are not actually using the ByteSafe™ parity feature may want to design the board site for the RAM with Pin 66 tied high through a 1k ohm resistor in Pipeline mode applications or tied low in Flow Through mode applications in order to keep the option to use non-configurable devices open. By using the pull-up resistor, rather than tying the pin to one of the power rails, users interested in upgrading to GSI's ByteSafe NBT SRAMs (GS881Z18/36), featuring Parity Error detection and JTAG Boundary Scan, will be ready for connection to the active low, open drain Parity Error output driver at Pin 66 on GSI's TQFP ByteSafe RAMs.

## Absolute Maximum Ratings

(All voltages reference to  $V_{SS}$ )

Symbol	Description	Value	Unit
$V_{DD}$	Voltage on $V_{DD}$ Pins	-0.5 to 4.6	V
$V_{DDQ}$	Voltage in $V_{DDQ}$ Pins	-0.5 to 4.6	V
$V_{I/O}$	Voltage on I/O Pins	-0.5 to $V_{DDQ} + 0.5$ ( $\leq 4.6$ V max.)	V
$V_{IN}$	Voltage on Other Input Pins	-0.5 to $V_{DD} + 0.5$ ( $\leq 4.6$ V max.)	V
$I_{IN}$	Input Current on Any Pin	+/-20	mA
$I_{OUT}$	Output Current on Any I/O Pin	+/-20	mA
$P_D$	Package Power Dissipation	1.5	W
$T_{STG}$	Storage Temperature	-55 to 125	$^{\circ}C$
$T_{BIAS}$	Temperature Under Bias	-55 to 125	$^{\circ}C$

### Note:

Permanent damage to the device may occur if the Absolute Maximum Ratings are exceeded. Operation should be restricted to Recommended Operating Conditions. Exposure to conditions exceeding the Absolute Maximum Ratings, for an extended period of time, may affect reliability of this component.

## Power Supply Voltage Ranges

Parameter	Symbol	Min.	Typ.	Max.	Unit
3.3 V Supply Voltage	$V_{DD3}$	3.0	3.3	3.6	V
2.5 V Supply Voltage	$V_{DD2}$	2.3	2.5	2.7	V
3.3 V $V_{DDQ}$ I/O Supply Voltage	$V_{DDQ3}$	3.0	3.3	3.6	V
2.5 V $V_{DDQ}$ I/O Supply Voltage	$V_{DDQ2}$	2.3	2.5	2.7	V

## $V_{DD3}$ Range Logic Levels

Parameter	Symbol	Min.	Typ.	Max.	Unit
Input High Voltage	$V_{IH}$	2.0	—	$V_{DD} + 0.3$	V
Input Low Voltage	$V_{IL}$	-0.3	—	0.8	V

### Note:

$V_{IHQ}$  (max) is voltage on  $V_{DDQ}$  pins plus 0.3 V.

### V<sub>DD2</sub> Range Logic Levels

Parameter	Symbol	Min.	Typ.	Max.	Unit
Input High Voltage	V <sub>IH</sub>	0.6*V <sub>DD</sub>	—	V <sub>DD</sub> + 0.3	V
Input Low Voltage	V <sub>IL</sub>	-0.3	—	0.3*V <sub>DD</sub>	V

**Note:**

V<sub>IHQ</sub> (max) is voltage on V<sub>DDQ</sub> pins plus 0.3 V.

### Operating Temperature

Parameter	Symbol	Min.	Typ.	Max.	Unit
Junction Temperature (Commercial Range Versions)	T <sub>J</sub>	0	25	85	°C
Junction Temperature (Industrial Range Versions)*	T <sub>J</sub>	-40	25	100	°C

**Note:**

\* The part numbers of Industrial Temperature Range versions end with the character "I". Unless otherwise noted, all performance specifications quoted are evaluated for worst case in the temperature range marked on the device.

### Thermal Impedance

Package	Test PCB Substrate	θ JA (C°/W) Airflow = 0 m/s	θ JA (C°/W) Airflow = 1 m/s	θ JA (C°/W) Airflow = 2 m/s	θ JB (C°/W)	θ JC (C°/W)
100 TQFP	4-layer	28.3	27.2	25.4	—	7.1

**Notes:**

1. Thermal Impedance data is based on a number of samples from multiple lots and should be viewed as a typical number.
2. Please refer to JEDEC standard JESD51-6.
3. The characteristics of the test fixture PCB influence reported thermal characteristics of the device. Be advised that a good thermal path to the PCB can result in cooling or heating of the RAM depending on PCB temperature.

### Undershoot Measurement and Timing

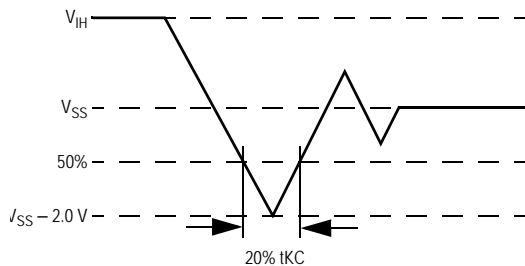

**Note:**

Input Under/overshoot voltage must be  $-2\text{ V} > V_i < V_{DDn} + 2\text{ V}$  not to exceed 4.6 V maximum, with a pulse width not to exceed 20% t<sub>KC</sub>.

### Overshoot Measurement and Timing

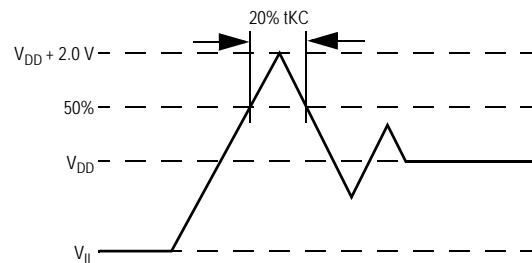

## Capacitance

( $T_A = 25^\circ\text{C}$ ,  $f = 1\text{ MHz}$ ,  $V_{DD} = 2.5\text{ V}$ )

Parameter	Symbol	Test conditions	Typ.	Max.	Unit
Input Capacitance	$C_{IN}$	$V_{IN} = 0\text{ V}$	4	5	pF
Input/Output Capacitance	$C_{I/O}$	$V_{OUT} = 0\text{ V}$	6	7	pF

### Note:

These parameters are sample tested.

## AC Test Conditions

Parameter	Conditions
Input high level	$V_{DD} - 0.2\text{ V}$
Input low level	$0.2\text{ V}$
Input slew rate	$1\text{ V/ns}$
Input reference level	$V_{DD}/2$
Output reference level	$V_{DDQ}/2$
Output load	Fig. 1

### Notes:

1. Include scope and jig capacitance.
2. Test conditions as specified with output loading as shown in Fig. 1 unless otherwise noted.
3. Device is deselected as defined by the Truth Table.

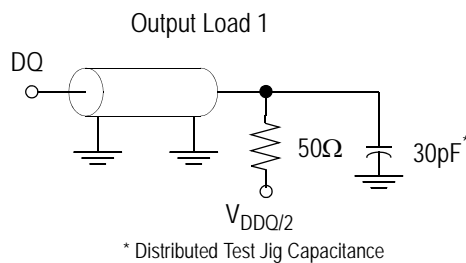

## DC Electrical Characteristics

Parameter	Symbol	Test Conditions	Min	Max
Input Leakage Current (except mode pins)	$I_{IL}$	$V_{IN} = 0$ to $V_{DD}$	-1 $\mu$ A	1 $\mu$ A
ZZ Input Current	$I_{IN1}$	$V_{DD} \geq V_{IN} \geq V_{IH}$ $0 V \leq V_{IN} \leq V_{IH}$	-1 $\mu$ A -1 $\mu$ A	1 $\mu$ A 100 $\mu$ A
$\overline{FT}$ Input Current	$I_{IN2}$	$V_{DD} \geq V_{IN} \geq V_{IL}$ $0 V \leq V_{IN} \leq V_{IL}$	-100 $\mu$ A -1 $\mu$ A	1 $\mu$ A 1 $\mu$ A
Output Leakage Current	$I_{OL}$	Output Disable, $V_{OUT} = 0$ to $V_{DD}$	-1 $\mu$ A	1 $\mu$ A
Output High Voltage	$V_{OH2}$	$I_{OH} = -8$ mA, $V_{DDQ} = 2.375$ V	1.7 V	—
Output High Voltage	$V_{OH3}$	$I_{OH} = -8$ mA, $V_{DDQ} = 3.135$ V	2.4 V	—
Output Low Voltage	$V_{OL}$	$I_{OL} = 8$ mA	—	0.4 V

## Operating Currents

Parameter	Test Conditions	Mode	Symbol	-250		-200		-166		-150		-100		Unit	
				0 to 70°C	-40 to 85°C	0 to 70°C	-40 to 85°C	0 to 70°C	-40 to 85°C	0 to 70°C	-40 to 85°C	0 to 70°C	-40 to 85°C		
Operating Current	Device Selected; All other inputs $\geq V_{IH}$ or $\leq V_{IL}$ Output open	(x32/ x36)	Pipeline	$I_{DD}$	195	215	170	190	160	180	140	160	120	140	mA
				$I_{DDQ}$	30	30	25	25	25	25	20	20	15	15	
		(x18)	Flow Through	$I_{DD}$	155	175	140	160	135	155	130	150	110	130	mA
				$I_{DDQ}$	25	25	20	20	20	20	15	15	15	15	
Standby Current	$ZZ \geq V_{DD} - 0.2$ V	—	Pipeline	$I_{SB}$	25	45	25	45	25	45	25	45	25	45	mA
			Flow Through	$I_{SB}$	25	45	25	45	25	45	25	45	25	45	mA
Deselect Current	Device Deselected; All other inputs $\geq V_{IH}$ or $\leq V_{IL}$	—	Pipeline	$I_{DD}$	65	85	65	85	65	85	60	80	60	80	mA
			Flow Through	$I_{DD}$	65	85	65	85	65	85	60	80	60	80	mA



## AC Electrical Characteristics

	Parameter	Symbol	-250		-200		-166		-150		-100		Unit
			Min	Max	Min	Max	Min	Max	Min	Max	Min	Max	
Pipeline	Clock Cycle Time	t <sub>KC</sub>	4.0	—	5.5	—	6.0	—	6.7	—	10	—	ns
	Clock to Output Valid	t <sub>KQ</sub>	—	2.5	—	3.0	—	3.5	—	3.8	—	4.5	ns
	Clock to Output Invalid	t <sub>KQX</sub>	1.5	—	1.5	—	1.5	—	1.5	—	1.5	—	ns
	Clock to Output in Low-Z	t <sub>LZ</sub> <sup>1</sup>	1.5	—	1.5	—	1.5	—	1.5	—	1.5	—	ns
	Setup time	t <sub>S</sub>	1.2	—	1.4	—	1.5	—	1.5	—	2.0	—	ns
	Hold time	t <sub>H</sub>	0.2	—	0.4	—	0.5	—	0.5	—	0.5	—	ns
Flow Through	Clock Cycle Time	t <sub>KC</sub>	5.5	—	6.5	—	7.0	—	7.5	—	12.0	—	ns
	Clock to Output Valid	t <sub>KQ</sub>	—	5.5	—	6.5	—	7.0	—	7.5	—	12.0	ns
	Clock to Output Invalid	t <sub>KQX</sub>	2.0	—	2.0	—	2.0	—	2.0	—	2.0	—	ns
	Clock to Output in Low-Z	t <sub>LZ</sub> <sup>1</sup>	2.0	—	2.0	—	2.0	—	2.0	—	2.0	—	ns
	Setup time	t <sub>S</sub>	1.5	—	1.5	—	1.5	—	1.5	—	2.0	—	ns
	Hold time	t <sub>H</sub>	0.5	—	0.5	—	0.5	—	0.5	—	0.5	—	ns
	Clock HIGH Time	t <sub>KH</sub>	1.3	—	1.3	—	1.3	—	1.3	—	1.3	—	ns
	Clock LOW Time	t <sub>KL</sub>	1.5	—	1.5	—	1.5	—	1.5	—	1.5	—	ns
	Clock to Output in High-Z	t <sub>HZ</sub> <sup>1</sup>	1.5	2.5	1.5	3.0	1.5	3.0	1.5	3.0	1.5	5	ns
	$\bar{G}$ to Output Valid	t <sub>OE</sub>	—	2.5	—	3.0	—	3.5	—	3.8	—	5	ns
	$\bar{G}$ to output in Low-Z	t <sub>OLZ</sub> <sup>1</sup>	0	—	0	—	0	—	0	—	0	—	ns
	$\bar{G}$ to output in High-Z	t <sub>OHZ</sub> <sup>1</sup>	—	2.5	—	3.0	—	3.0	—	3.0	—	5	ns
	ZZ setup time	t <sub>ZS</sub> <sup>2</sup>	5	—	5	—	5	—	5	—	5	—	ns
	ZZ hold time	t <sub>ZH</sub> <sup>2</sup>	1	—	1	—	1	—	1	—	1	—	ns
	ZZ recovery	t <sub>ZZR</sub>	20	—	20	—	20	—	20	—	20	—	ns

## Notes:

1. These parameters are sampled and are not 100% tested.
2. ZZ is an asynchronous signal. However, in order to be recognized on any given clock cycle, ZZ must meet the specified setup and hold times as specified above.

## Pipeline Mode Timing

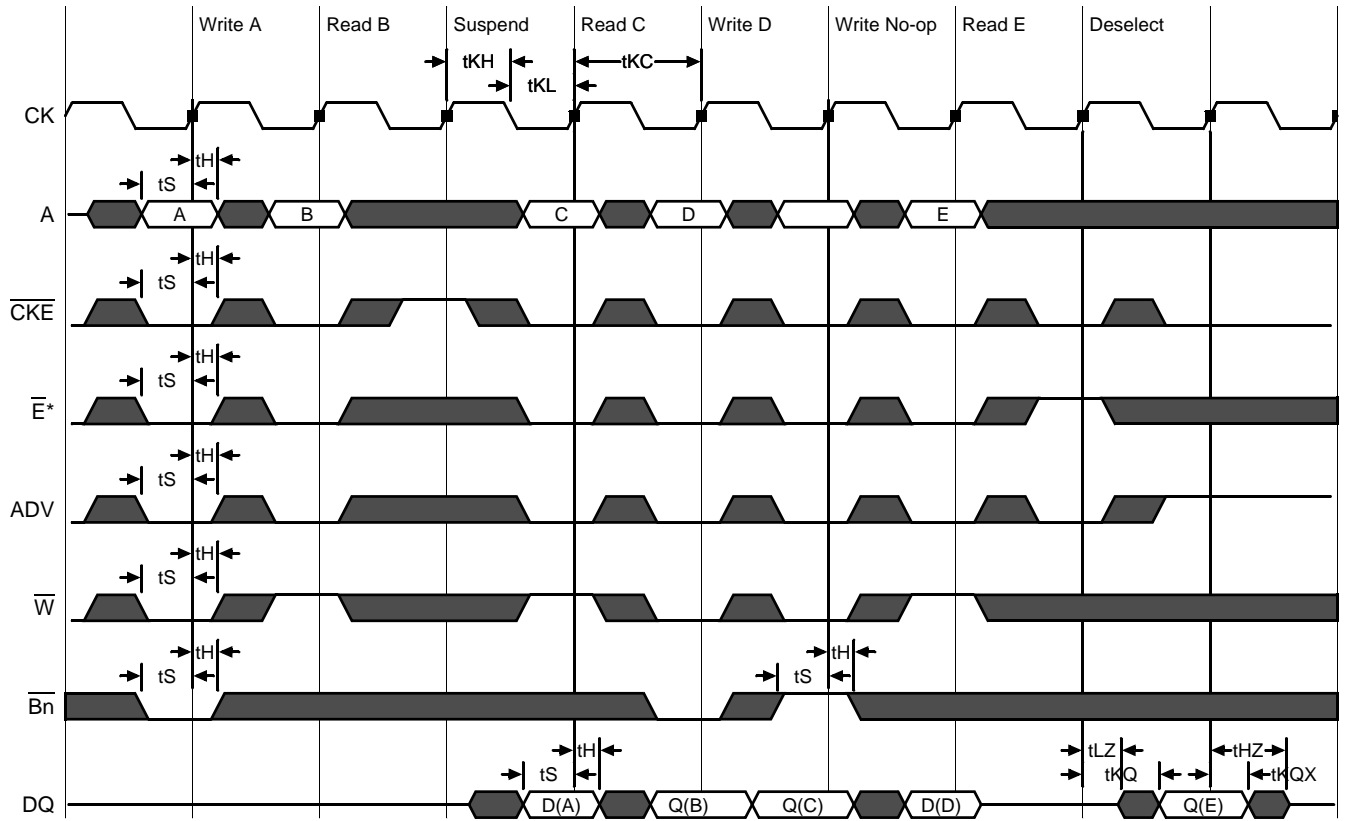

## Flow Through Mode Timing

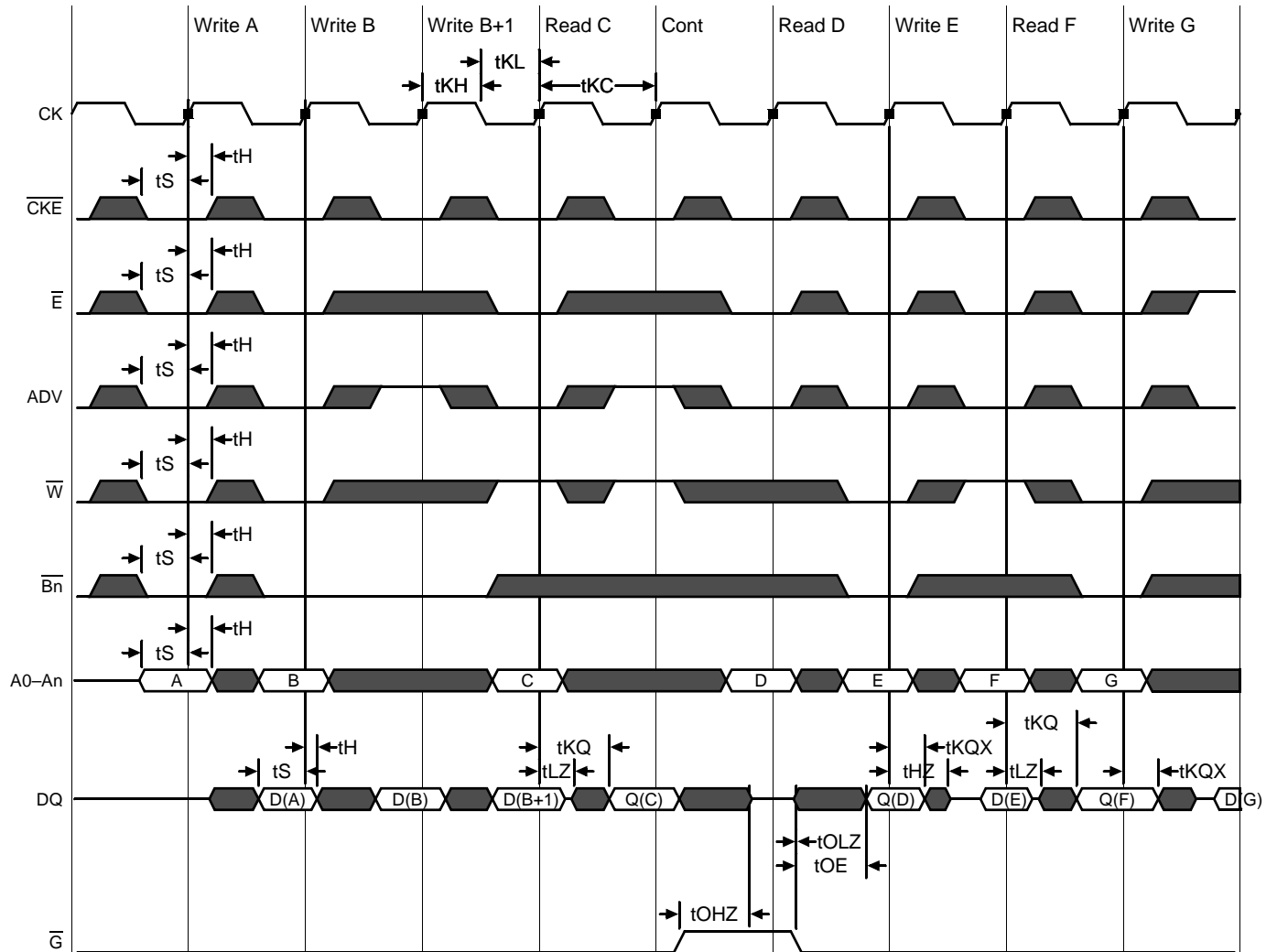

\*Note:  $\bar{E}$  = High(False) if  $\bar{E}1 = 1$  or  $\bar{E}2 = 0$  or  $\bar{E}3 = 1$

## TQFP Package Drawing (Package T)

Symbol	Description	Min.	Nom.	Max
A1	Standoff	0.05	0.10	0.15
A2	Body Thickness	1.35	1.40	1.45
b	Lead Width	0.20	0.30	0.40
c	Lead Thickness	0.09	—	0.20
D	Terminal Dimension	21.9	22.0	22.1
D1	Package Body	19.9	20.0	20.1
E	Terminal Dimension	15.9	16.0	16.1
E1	Package Body	13.9	14.0	14.1
e	Lead Pitch	—	0.65	—
L	Foot Length	0.45	0.60	0.75
L1	Lead Length	—	1.00	—
Y	Coplanarity			0.10
$\theta$	Lead Angle	0°	—	7°

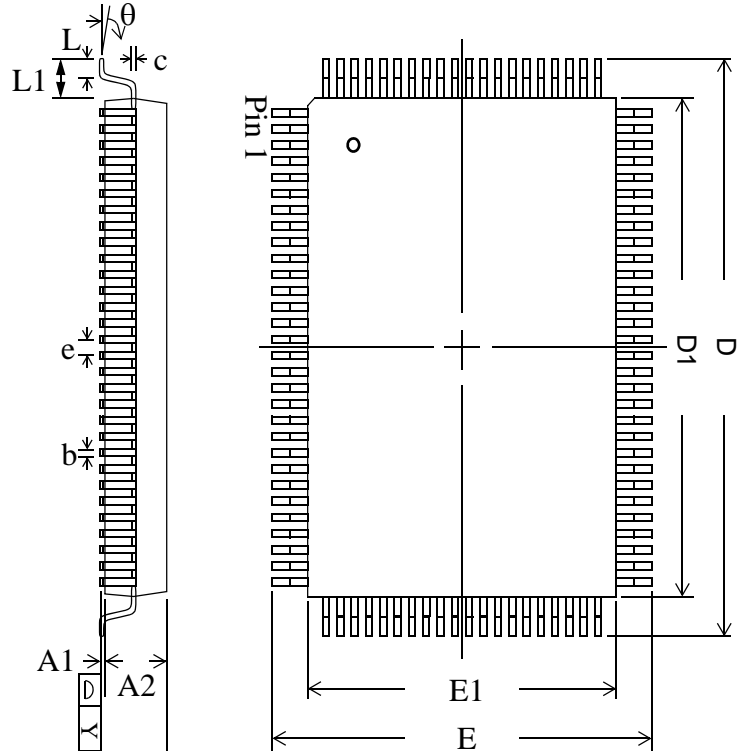
**Notes:**

1. All dimensions are in millimeters (mm).
2. Package width and length do not include mold protrusion.

BPR 1999.05.18

## Ordering Information—GSI NBT Synchronous SRAMs

Org	Part Number <sup>1</sup>	Type	Package	Speed <sup>2</sup> (MHz/ns)	T <sub>J</sub> <sup>3</sup>
256K x 18	GS840Z18CGT-250	NBT Pipeline/Flow Through	RoHS-compliant TQFP	250/5.5	C
256K x 18	GS840Z18CGT-200	NBT Pipeline/Flow Through	RoHS-compliant TQFP	200/6.5	C
256K x 18	GS840Z18CGT-166	NBT Pipeline/Flow Through	RoHS-compliant TQFP	166/7.0	C
256K x 18	GS840Z18CGT-150	NBT Pipeline/Flow Through	RoHS-compliant TQFP	150/7.5	C
256K x 18	GS840Z18CGT-100	NBT Pipeline/Flow Through	RoHS-compliant TQFP	100/12	C
128K x 36	GS840Z36CGT-250	NBT Pipeline/Flow Through	RoHS-compliant TQFP	250/5.5	C
128K x 36	GS840Z36CGT-200	NBT Pipeline/Flow Through	RoHS-compliant TQFP	200/6.5	C
128K x 36	GS840Z36CGT-166	NBT Pipeline/Flow Through	RoHS-compliant TQFP	166/7.0	C
128K x 36	GS840Z36CGT-150	NBT Pipeline/Flow Through	RoHS-compliant TQFP	150/7.5	C
128K x 36	GS840Z36CGT-100	NBT Pipeline/Flow Through	RoHS-compliant TQFP	100/12	C
256K x 18	GS840Z18CGT-250I	NBT Pipeline/Flow Through	RoHS-compliant TQFP	250/5.5	I
256K x 18	GS840Z18CGT-200I	NBT Pipeline/Flow Through	RoHS-compliant TQFP	200/6.5	I
256K x 18	GS840Z18CGT-166I	NBT Pipeline/Flow Through	RoHS-compliant TQFP	166/7.0	I
256K x 18	GS840Z18CGT-150I	NBT Pipeline/Flow Through	RoHS-compliant TQFP	150/7.5	I
256K x 18	GS840Z18CGT-100I	NBT Pipeline/Flow Through	RoHS-compliant TQFP	100/12	I
128K x 36	GS840Z36CGT-250I	NBT Pipeline/Flow Through	RoHS-compliant TQFP	250/5.5	I
128K x 36	GS840Z36CGT-200I	NBT Pipeline/Flow Through	RoHS-compliant TQFP	200/6.5	I
128K x 36	GS840Z36CGT-166I	NBT Pipeline/Flow Through	RoHS-compliant TQFP	166/7.0	I
128K x 36	GS840Z36CGT-150I	NBT Pipeline/Flow Through	RoHS-compliant TQFP	150/7.5	I
128K x 36	GS840Z36CGT-100I	NBT Pipeline/Flow Through	RoHS-compliant TQFP	100/12	I

## Notes:

1. Customers requiring delivery in Tape and Reel should add the character "T" to the end of the part number. Example: GS840Z36CGT-100IT.
2. The speed column indicates the cycle frequency (MHz) of the device in Pipeline mode and the latency (ns) in Flow Through mode. Each device is Pipeline/Flow Through mode-selectable by the user.
3. C = Commercial Temperature Range. I = Industrial Temperature Range.
4. GSI offers other versions this type of device in many different configurations and with a variety of different features, only some of which are covered in this data sheet. See the GSI Technology web site ([www.gsistechnology.com](http://www.gsistechnology.com)) for a complete listing of current offerings.

#### 4Mb Synchronous NBT Datasheet Revision History

File Name	Types of Changes Format or Content	Revision
840ZxxC_r1		• Creation of new datasheet
840ZxxC_r1_01	Content	• Updated Operating Currents table

## X-ON Electronics

Largest Supplier of Electrical and Electronic Components

*Click to view similar products for [SRAM](#) category:*

*Click to view products by [GSI Technology](#) manufacturer:*

Other Similar products are found below :

[CY6116A-35DMB](#) [CY7C1049GN-10VXI](#) [CY7C1461KV33-133AXI](#) [GS8161Z36DD-200I](#) [GS88237CB-200I](#) [RMLV0408EGSB-4S2#AA0](#)  
[IS64WV3216BLL-15CTLA3](#) [IS66WVE4M16ECLL-70BLI](#) [PCF8570P](#) [K6F2008V2E-LF70000](#) [K6T4008C1B-GB70](#) [CY7C1353S-100AXC](#)  
[AS6C8016-55BIN](#) [AS7C164A-15PCN](#) [515712X](#) [IS62WV51216EBLL-45BLI](#) [IS63WV1288DBLL-10HLI](#) [IS66WVE2M16ECLL-70BLI](#)  
[IS66WVE4M16EALL-70BLI](#) [IS61WV102416DBLL-10TLI](#) [CY7C1381KV33-100AXC](#) [CY7C1460KV25-200BZI](#) [CY7C1373KV33-100AXC](#)  
[CY7C1381KVE33-133AXI](#) [CY7C4121KV13-600FCXC](#) [GS882Z18CD-150I](#) [IS66WVC2M16ECLL-7010BLI](#) [7140LA35PDG](#)  
[CY7C1380KV33-250AXC](#) [AS6C8016-55BINTR](#) [CY7C1370KV33-250AXC](#) [CY7C1370KVE33-167AXI](#) [7140LA100PDG](#) [AS7C34096B-](#)  
[10TIN](#) [AS6C8016-55TIN](#) [IS62WV25616EALL-55TLI](#) [GS8128418B-167IV](#) [CY7C1460KV25-200BZXI](#) [CY7C1460KV25-167BZXI](#)  
[CY7C1315KV18-333BZXC](#) [CY7C1370KV25-200AXC](#) [71421LA55JI8](#) [CY62158G30-45ZSXI](#) [CY62157G30-45ZSXI](#) [RMLV3216AGSD-](#)  
[5S2#AA0](#) [CY62187G30-55BAXI](#) [CY62157G30-45ZXI](#) [IS61VVPS102436B-200B3LI](#) [IS66WVC2M16EALL-7010BLI](#)  
[IS66WVE4M16EALL-70BLI-TR](#)