

Features

- Low Supply Current~55uA (Typ.)
- Low Shutdown Current ~0.1uA (Typ.)
- Output Current ~300mA
- High Power Supply Rejection Ratio ~75dB@1KHz
- 1.7~5.5V Operation
- ±1.5% Initial Voltage Accuracy
- Low Temperature Drift Coefficient ~50ppm
- Line Regulation ~0.02%/V(Typ.)
- Low ESR Capacitor ~1.0uF ceramic capacitor
- WDFN4-1.2x1.6 · TDFN6-1.8x2 · SOT-23-5 · SOT-89-3 · MSOT-23 and SOT-353 package
- Green Product (RoHS, Lead-Free, Halogen-Free Compliant)

Applications

- Portable communication equipment
- Notebook Computer
- Battery Powered Systems

Typical Application

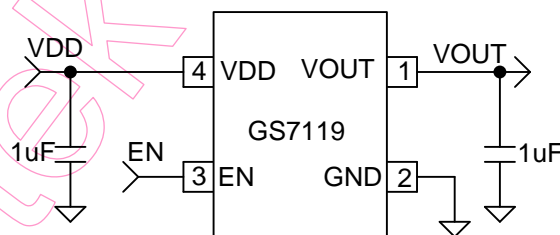

Figure 1 Typical Application of GS7119

General Description

The GS7119 is a CMOS linear regulator. It is featuring ultra-high power supply rejection ratio, low output voltage noise, low dropout voltage, low quiescent current and fast transient response. It guarantees delivery of 300mA output current, and supports preset 1.2V, 1.3V, 1.5V, 1.7V, 1.8V, 1.85V, 1.9V, 2.0V, 2.3V, 2.5V, 2.6V, 2.7V, 2.8V, 2.85V, 2.9V, 3.0V, 3.1V, 3.3V output voltage versions.

Based on its low quiescent current consumption and its less than 1uA shutdown mode, the GS7119 is ideal for battery- powered applications. The high power supply rejection ratio of the GS7119 holds well for low input voltages typically encountered in battery- operated systems. The regulator is stable with small ceramic capacitive loads (1μF typical).

Function Block Diagram

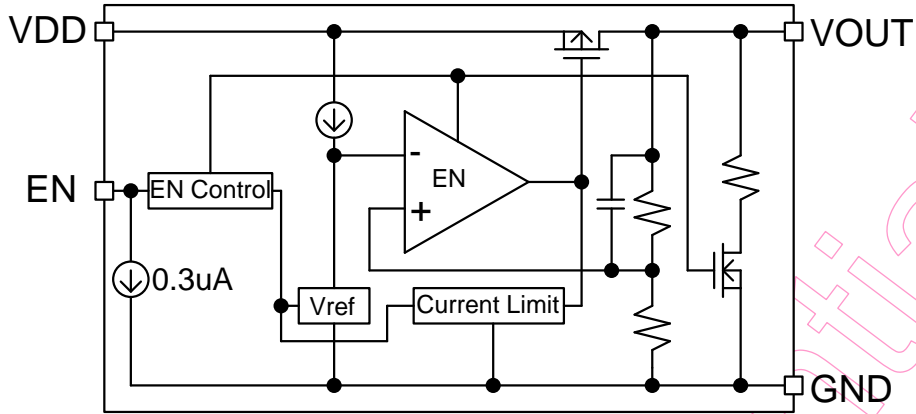

Figure 2a with auto discharge function (default)

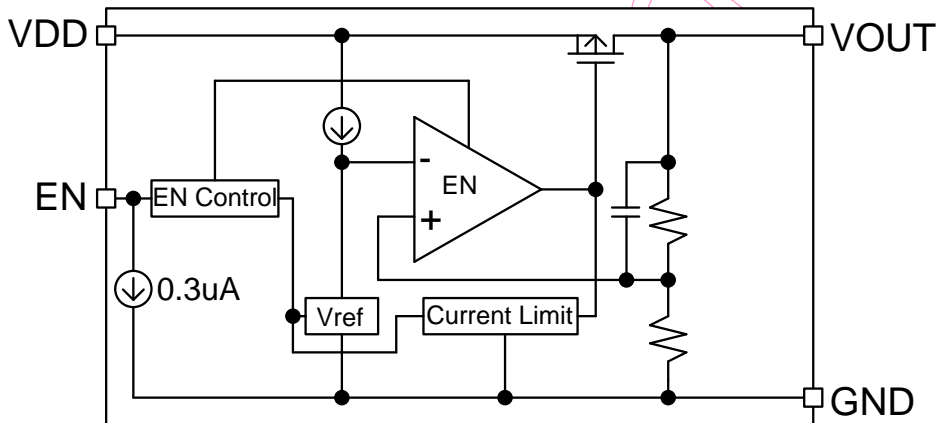

Figure 2b without auto discharge function (special order)

Figure 2 Function Block Diagram

Pin Configuration

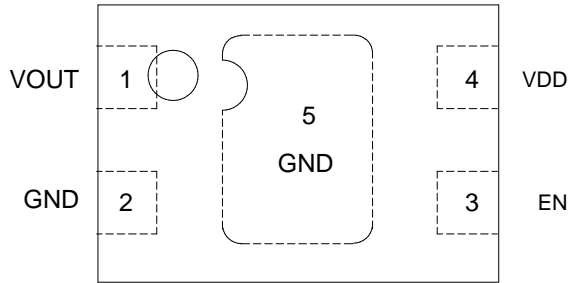

Figure 3a WDFN4-1.2x1.6 Package

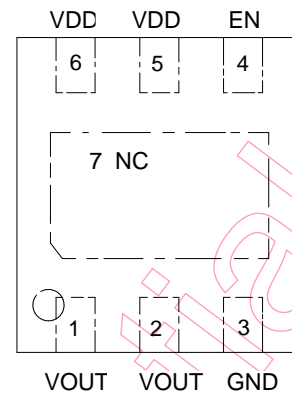

Figure 3b TDFN6-1.8x2 package

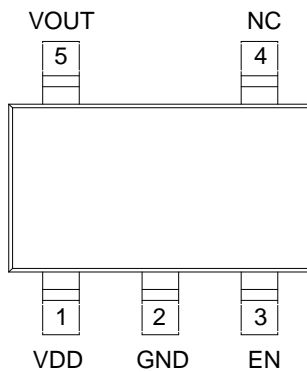

Figure 3c SOT-23-5
/SOT-353 Package

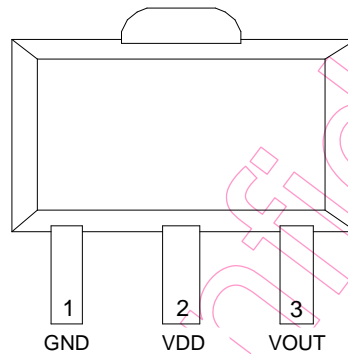

Figure 3d SOT-89-3 Package

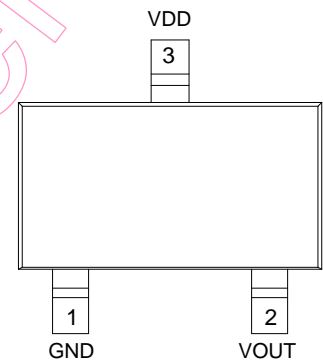
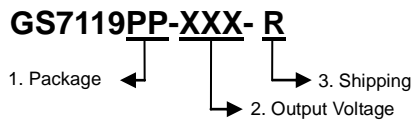

Figure 3e MSOT-23 Package

Pin Descriptions

		No			Name	I/O type	Description
WDFN4-1.2x1.6	TDFN6-1.8x2	SOT-23-5/ SOT-353	SOT-89-3	MSOT-23			
1	1, 2	5	3	2	VOUT	O	Output pin
2, 5	3	2	1	1	GND	O	Ground pin
3	4	3			EN	I	Enable Pin
4	5,6	1	2	3	VDD	I	Input Pin
	7	4			NC		

Ordering Information



No	Item	Contents
1	Package	UD: WDFN4-1.2x1.6 TD: TDFN6-1.8x2 ST: SOT-23-5 S9: SOT-89-3 SR: MSOT-23 C5: SOT-353(SC-75)
2	Output Voltage	1P2: 1.2V, 1P3: 1.3V, 1P5: 1.5V, 1P7:1.7V, 1P8: 1.8V, 185: 1.85V, 1P9: 1.9V, 2P0: 2.0V, 2P3: 2.3V, 2P5: 2.5V, 2P6: 2.6V, 2P7: 2.7V, 2P8: 2.8V, 285: 2.85V, 2P9: 2.9V, 3P0: 3.0V, 3P1: 3.1V, 3P3: 3.3V
3	Shipping	R: Tape & Reel

Example: GS7119 2.5V SOT-23-5 Tape & Reel ordering information is “GS7119ST-2P5-R”

Absolute Maximum Rating (Note 1)

Parameter	Symbol	Limits	Units
V _{IN} to GND	V _{IN}	-0.3 < V _{IN} < 6	V
V _{EN} to GND	V _{EN}	-0.3 < V _{EN} < 6	V
Output Voltage	V _{OUT}	-0.3 < V _{OUT} < V _{IN} +0.3	V
Output Current	I _{OUT}	300	mA
Package Power Dissipation at T _A ≤ 25°C	P _{D_WDFN4-1.2x1.6}	500	mW
Package Power Dissipation at T _A ≤ 25°C	P _{D_TDFN6-1.8x2}	880	mW
Package Power Dissipation at T _A ≤ 25°C	P _{D_SOT-23-5}	420	mW
Package Power Dissipation at T _A ≤ 25°C	P _{D_SOT-89-3}	571	mW
Package Power Dissipation at T _A ≤ 25°C	P _{D_MSOT-23}	380	mW
Package Power Dissipation at T _A ≤ 25°C	P _{D_SOT-353}	300	mW
Storage Temperature	T _{STG}	- 65 ~ 150	°C
Lead Temperature (Soldering) 10S	T _{LEAD}	260	°C
ESD (Human Body Mode) (Note 2)	V _{ESD_HBM}	2K	V
ESD (Machine Mode) (Note 2)	V _{ESD_MM}	200	V

Thermal Information (Note 3)

Parameter	Symbol	Limits	Units
Thermal Resistance Junction to Ambient	θ _{JA_WDFN4-1.2x1.6}	200	°C/W
Thermal Resistance Junction to Ambient	θ _{JA_TDFN6-1.8x2}	114	°C/W
Thermal Resistance Junction to Ambient	θ _{JA_SOT-23-5}	238	°C/W
Thermal Resistance Junction to Ambient	θ _{JA_SOT-89-3}	182	°C/W
Thermal Resistance Junction to Ambient	θ _{JA_MSOT-23}	263	°C/W
Thermal Resistance Junction to Ambient	θ _{JA_SOT-353}	333	°C/W

Recommend Operating Condition (Note 4)

Parameter	Symbol	Limits	Units
V _{IN} to GND	V _{IN}	1.7 to 5.5	V
Junction Temperature	T _J	- 40 ~ 125	°C
Operating Temperature Range	T _A	-40 ~ 85	°C

Electrical Characteristics

($V_{IN} = V_{OUT} + 1V$, $T_A = 25^\circ C$, $C_{IN}=C_L=0.47\mu F$, $I_{OUT}=1mA$, unless otherwise specified)

Parameter	Symbol	Conditions	Min	Typ	Max	Units
SUPPLY VOLTAGE SECTION						
Supply Voltage	V_{IN}		1.7		5.5	V
Supply Current	I_{VIN}	Unload		55	70	μA
Standby Current	I_{STBY}	$V_{EN}=0$		0.1	1.0	μA
EN Input Current	I_{EN}	$V_{EN}=V_{IN}=5.5V$		0.3		μA
Output Current(Note 5)	I_{OUT}		300 (Note 6)			mA
OUTPUT SECTION						
Output Voltage	V_{OUT}	$T_A = 25^\circ C$	-1.5		+1.5	%
Dropout Voltage (Note 7)	V_{DROP}	$I_{OUT}=300mA$ (For WDFN4-1.2x1.6, , SOT-23-5, SOT-89-3 package)	$V_{OUT}=1.2V$	495	650	mV
			$V_{OUT}=1.5V$	375	490	
			$V_{OUT}=2.5V$	235	295	
			$V_{OUT}=2.8V$	220	275	
			$V_{OUT}=3.3V$	195	245	
		$I_{OUT}=300mA$ (For MSOT-23 package)	$V_{OUT}=1.5V$	500	680	
	$V_{OUT}=1.8V$	400	490			
	$V_{OUT}=2.8V$	260	340			
Line Regulation	ΔV_{LNR}	$V_{IN} = V_{OUT} + 0.5V$ to $5.5V$, $I_{OUT}=1mA$		0.02	0.20	%/V
Load Regulation	ΔV_{LDR}	$V_{IN} = V_{OUT} + 1V$, $I_{OUT}=1mA$ to $150mA$		15	40	mV
Ripple Rejection Rate	PSRR	$V_{IN} = \text{MAX}\{V_{OUT} + 1.0V, 3V\}$, Ripple $0.2Vp-p$, $I_{OUT}=30mA$, $f=1KHz$		78		dB
Limit Current	I_{lim}	$V_{EN}=V_{IN}$		460		mA
Short Current	I_{short}	$V_{OUT}=0V$		40		mA
EN Input Voltage High	V_{ENH}		1.2			V
EN Input Voltage Low	V_{ENL}				0.3	V
CL Auto-Discharge Resistance (Note 8)	R_{dischg}	$V_{IN}=5.0V$, $V_{EN}=0V$		95		Ω
Temperature Drift	$\Delta V_{OUT} / \Delta T_A$	$I_{OUT}=1mA$, $T_A = -40^\circ C$ to $+85^\circ C$		40		ppm/ $^\circ C$

Thermal Shutdown Temperature	T_{SD}	T_J Rising		165		°C
Thermal Shutdown Returned Temperature				145		°C

Note 1. Stresses listed as the above “Absolute Maximum Ratings” may cause permanent damage to the device. These are for stress ratings. Functional operation of the device at these or any other conditions beyond those indicated in the operational sections of the specifications is not implied. Exposure to absolute maximum rating conditions for extended periods may remain possibility to affect device reliability.

Note 2. Devices are ESD sensitive. Handling precaution recommended.

Note 3. θ_{JA} is measured in the natural convection at $T_A=25^\circ\text{C}$ on a high effective thermal conductivity test board (40mm x 40mm x 1.6mm double sided board with 2oz, copper ratio: approx. 50%) of JEDEC 51-7 thermal measurement standard.

Note 4. The device is not guaranteed to function outside its operating conditions.

Note 5. The output current at which the output voltage becomes 95% of V_{OUT} after gradually increasing the output current.

Note 6. The output current can be at least this value. Due to restrictions on the package power dissipation, this value may not be satisfied. Attention should be paid to the power dissipation of the package when the output current is large.

The specification is guaranteed by design.

Note 7. The dropout voltage is defined as $V_{IN} - V_{OUT}$, which is measured when V_{OUT} is $98\% \cdot V_{OUT}$.

Note 8. The output voltage Auto discharge function is optional.

Typical Characteristics

Output Voltage vs. Output Current (Cin=1.0uF,Cout=1.0uF,Temp=25°C)

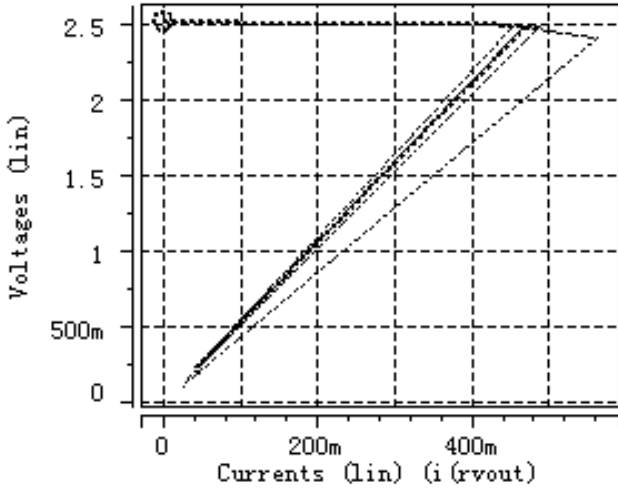

V_{OUT}=2.5V, V_{DD}=1.3V,1.5V,2.0V,3.0V,5.0V

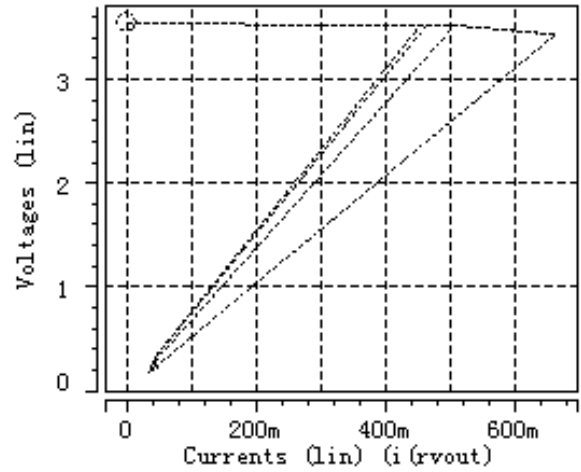

V_{OUT}=3.5V, V_{DD}=3.8V,4.0V,4.5V,5.0V

Output Voltage vs. Input Voltage (Cin=1.0uF,Cout=1.0uF,Temp=25°C)

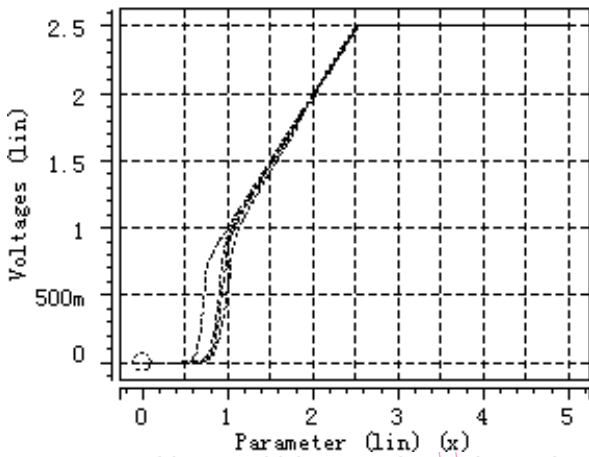

V_{OUT}=2.5V, I_{OUT}=1mA,30mA,50mA

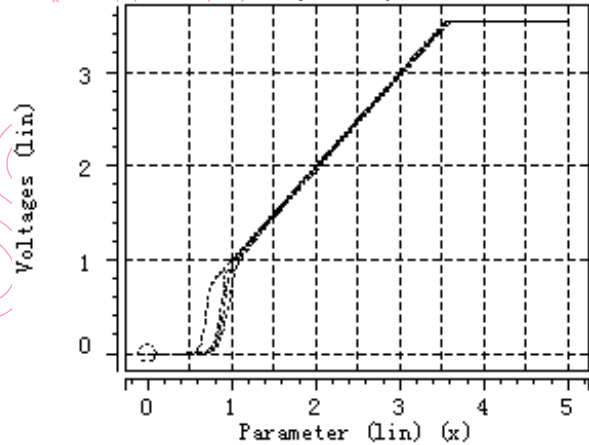

V_{OUT}=3.5V, I_{OUT}=1mA,30mA,50mA

Supply Current vs. Input Voltage (Cin=1.0uF,Cout=1.0uF,Temp=25°C)

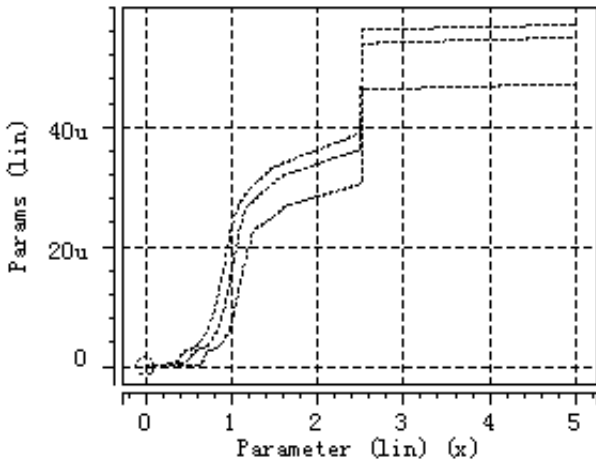

V_{OUT}=2.5V, no load

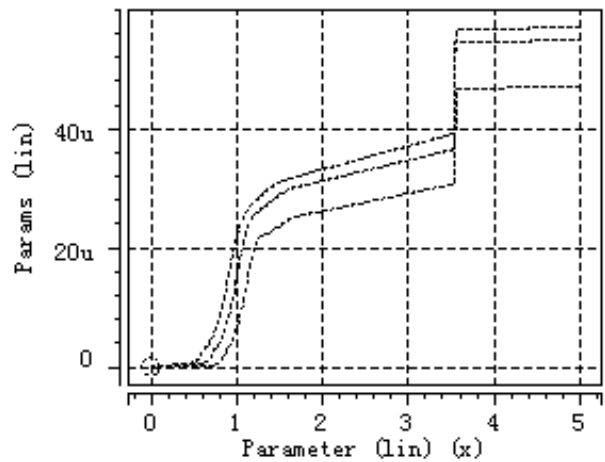

V_{OUT}=3.5V, no load

Output Voltage vs. Temperature (Cin=1.0uF,Cout=1.0uF,Iout=1mA)

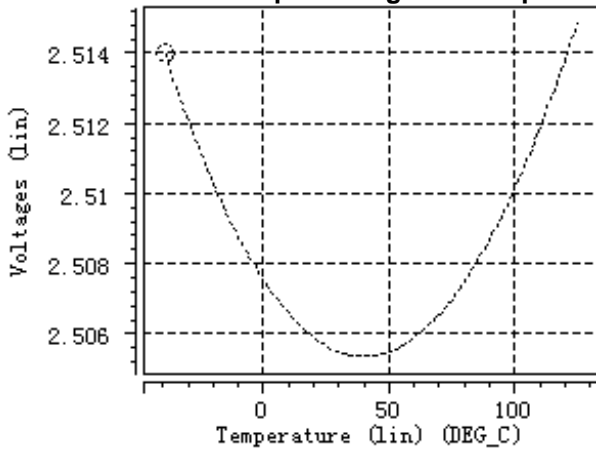

$V_{OUT}=2.5V, V_{DD}=3.5V, \text{no load}$

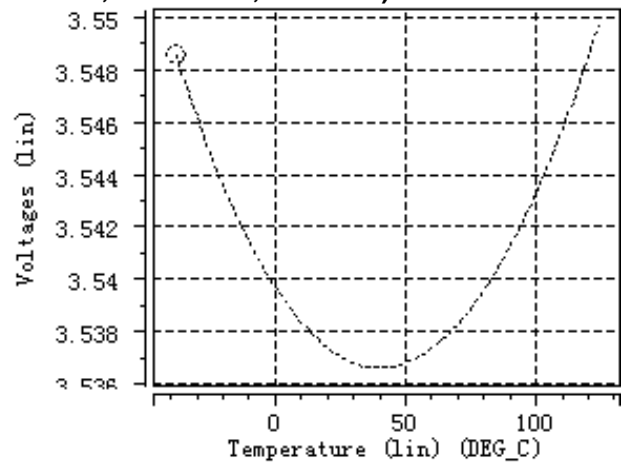

$V_{OUT}=3.5V, V_{DD}=4.5V, \text{no load}$

Supply Current vs. Temperature (Cin=1.0uF,Cout=1.0uF,Iout=0mA)

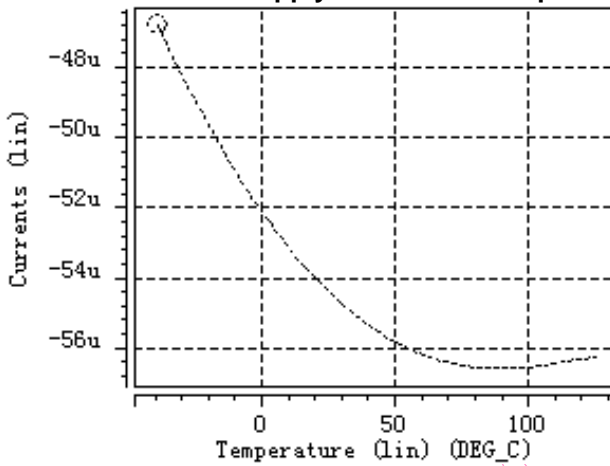

$V_{OUT}=2.5V, V_{DD}=3.5V, \text{no load}$

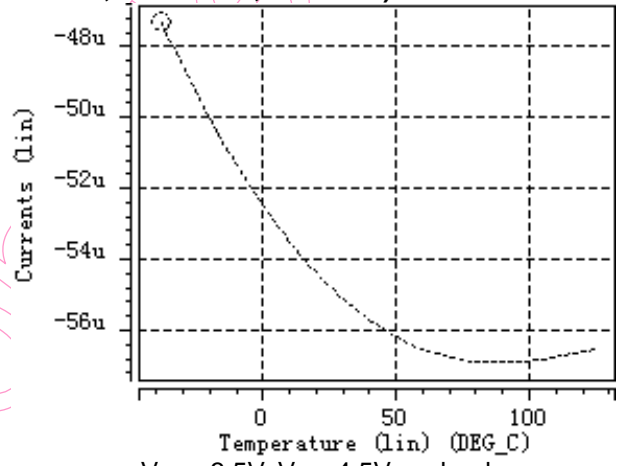

$V_{OUT}=3.5V, V_{DD}=4.5V, \text{no load}$

Dropout Voltage vs. Output Current (Cin=1.0uF,Cout=1.0uF)

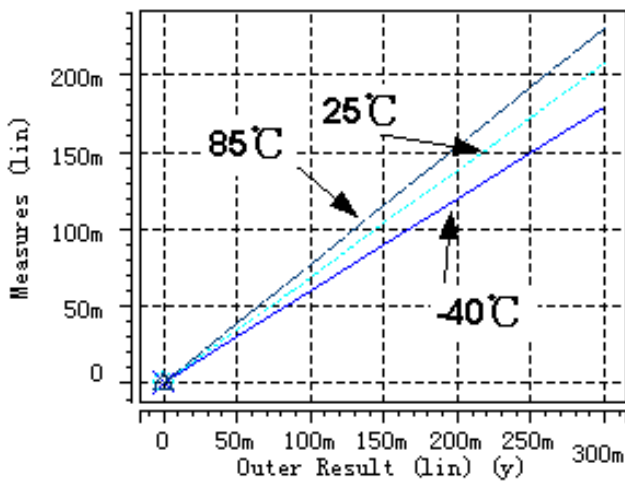

$V_{OUT}=2.5V$

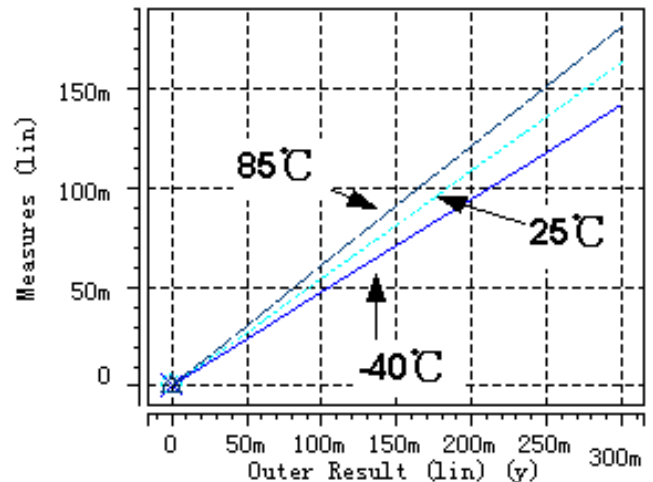

$V_{OUT}=3.5V$

Dropout Voltage vs. Set Output Voltage (Cin=1.0uF,Cout=1.0uF,Temp=25°C)

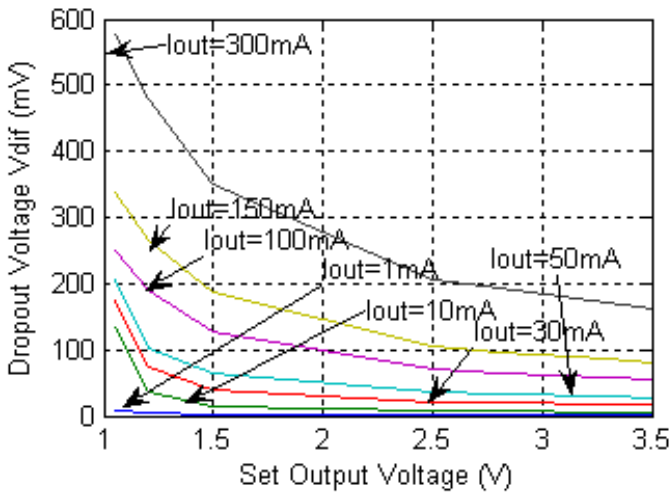

Ripple Rejection vs. Input Bias Voltage (Cin=none, Cout=1.0uF, Ripple=0.2Vp-p, Temp=25°C)

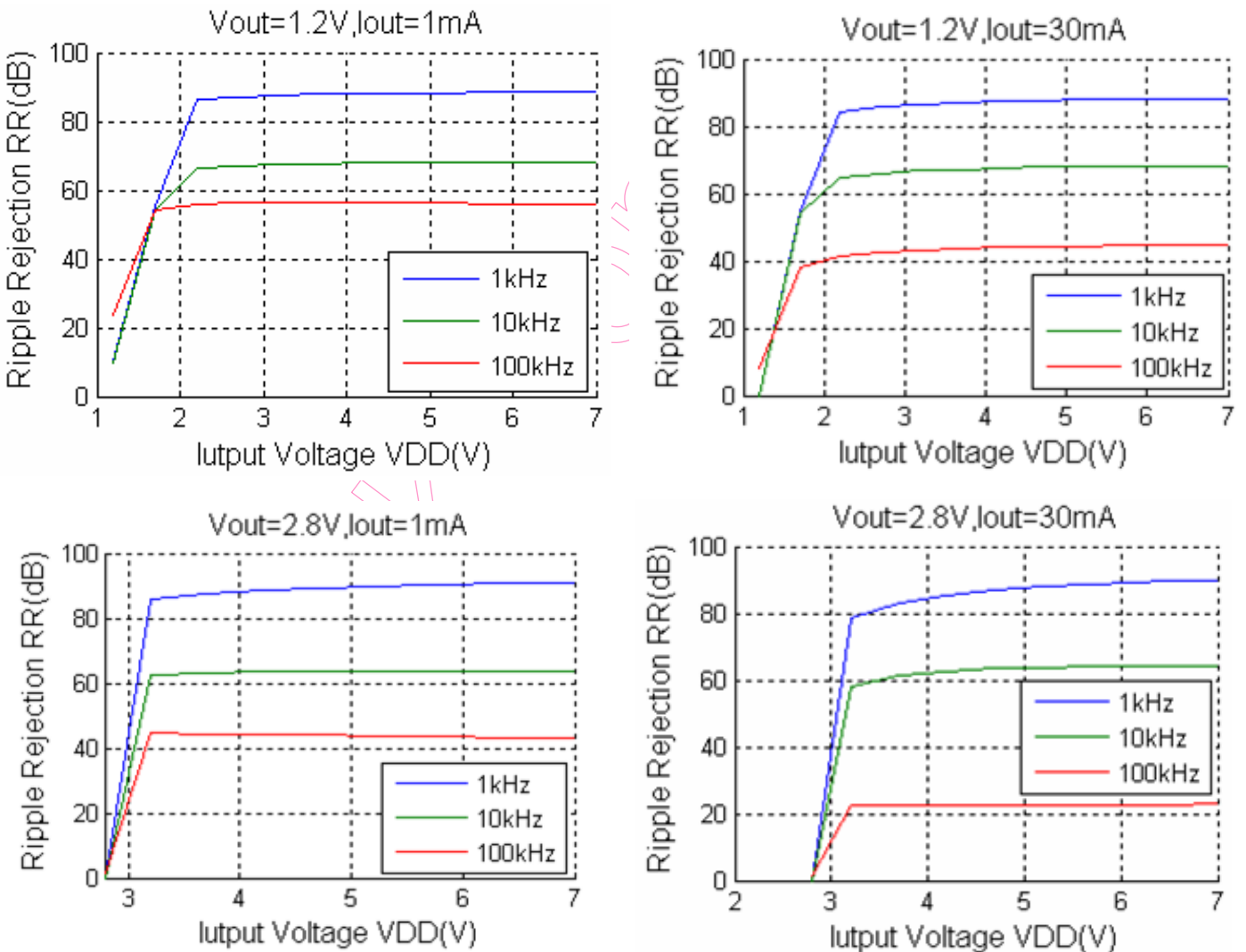

Ripple Rejection vs. Frequency (Cin=none, Cout=1.0uF, Ripple=0.2Vp-p)

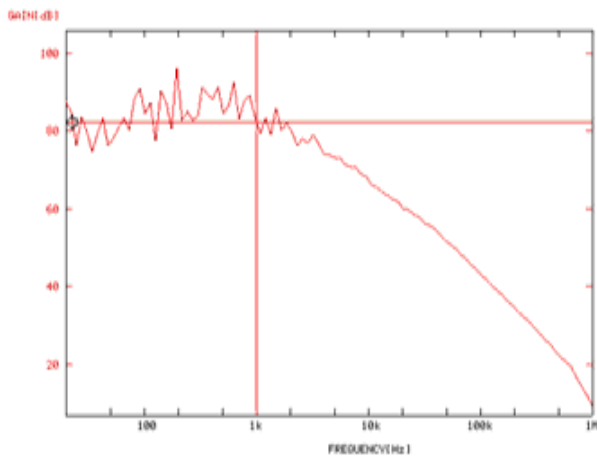

$V_{OUT}=1.8V, V_{DD}=2.8V, I_{OUT}=30mA$

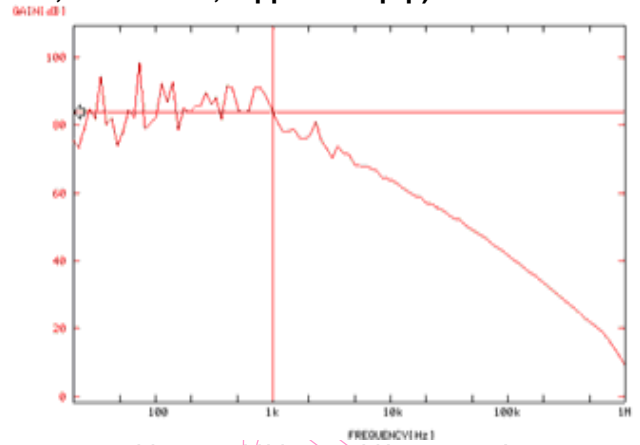

$V_{OUT}=1.8V, V_{DD}=4.8V, I_{OUT}=30mA$

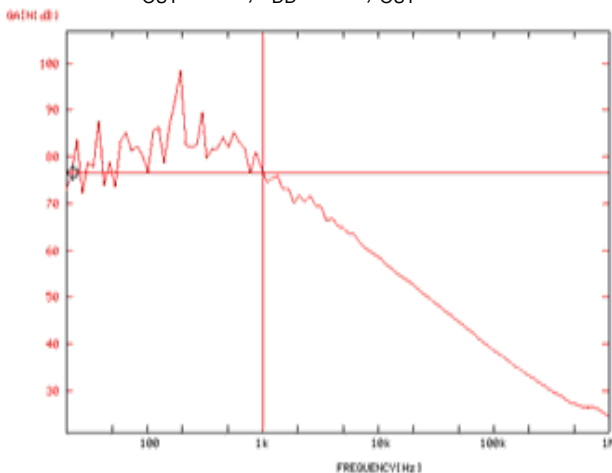

$V_{OUT}=2.5V, V_{DD}=3.5V, I_{OUT}=30mA$

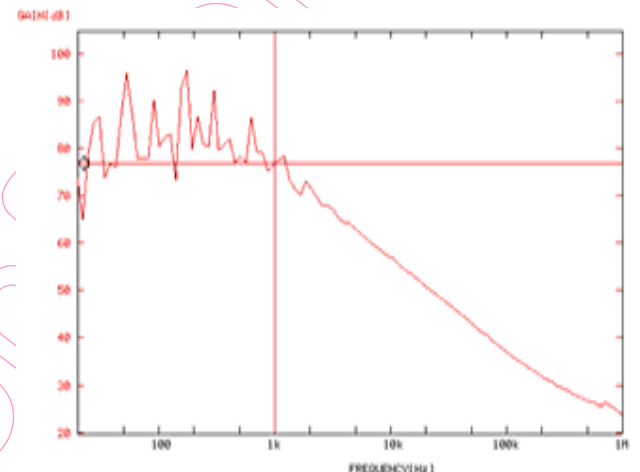

$V_{OUT}=2.5V, V_{DD}=5.5V, I_{OUT}=30mA$

Input Transient Response (Iout=30mA, tr=tf=5us, Temp=25°C)

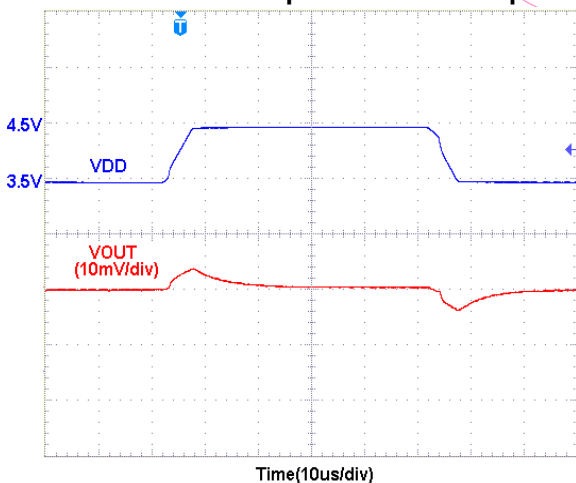

$V_{OUT}=2.5V, V_{DD}=3.5V \sim 4.5V \sim 3.5V$

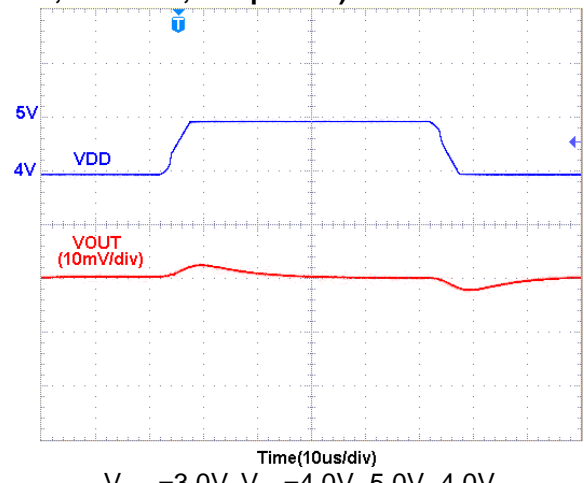

$V_{OUT}=3.0V, V_{DD}=4.0V \sim 5.0V \sim 4.0V$

Load Transient Response (Cout=1.0uF, Temp=25°C)

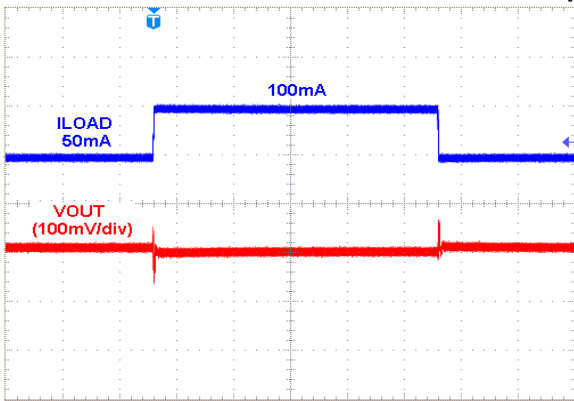

Time(100us/div)
 $V_{OUT}=2.5V$, $I_{OUT}=50mA \sim 100mA \sim 50mA$, $V_{DD}=3.5V$
 $tr=tf=0.5us$

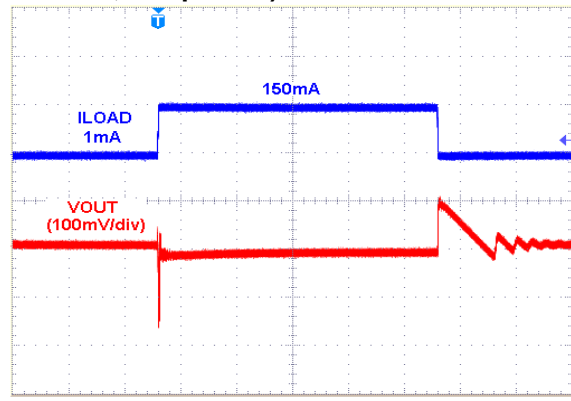

Time(100us/div)
 $V_{OUT}=2.5V$, $I_{OUT}=1mA \sim 150mA \sim 1mA$, $V_{DD}=3.5V$
 $tr=tf=0.5us$

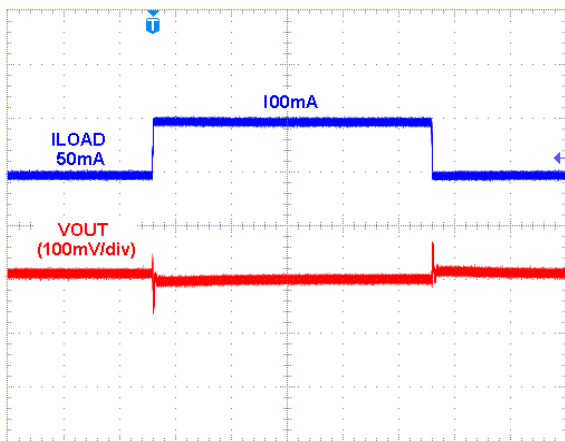

Time(100us/div)
 $V_{OUT}=3.0V$, $I_{OUT}=50mA \sim 100mA \sim 50mA$, $V_{DD}=4.0V$
 $tr=tf=0.5us$

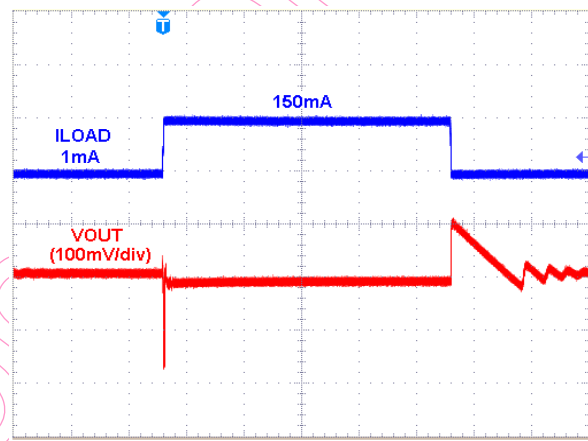

Time(100us/div)
 $V_{OUT}=3.0V$, $I_{OUT}=1mA \sim 150mA \sim 1mA$, $V_{DD}=4.0V$
 $tr=tf=0.5us$

Turn On Speed with EN pin (Cin=1.0uF, Cout=1.0uF, Temp=25°C)

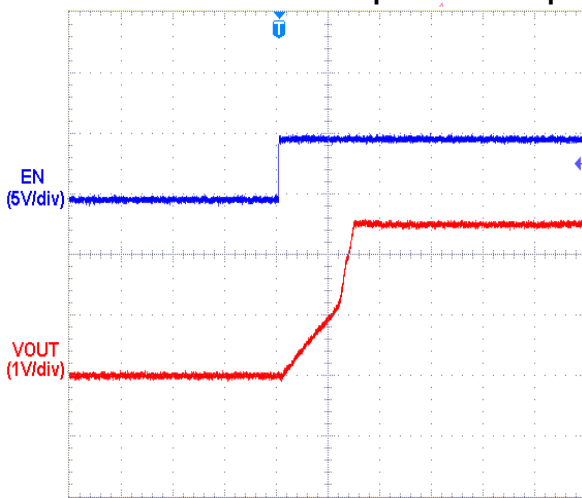

Time(20us/div)
 $V_{OUT}=2.5V$, $I_{OUT}=0mA$, $V_{DD}=3.5V$

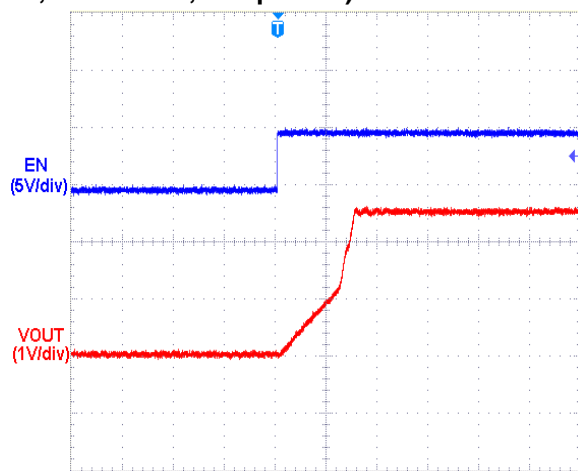

Time(20us/div)
 $V_{OUT}=2.5V$, $I_{OUT}=10mA$, $V_{DD}=3.5V$

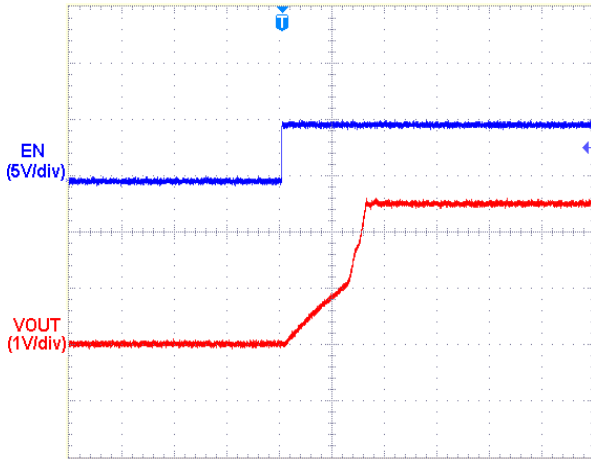

Time(20us/div)
 $V_{OUT}=2.5V, I_{OUT}=30mA, V_{DD}=3.5V$

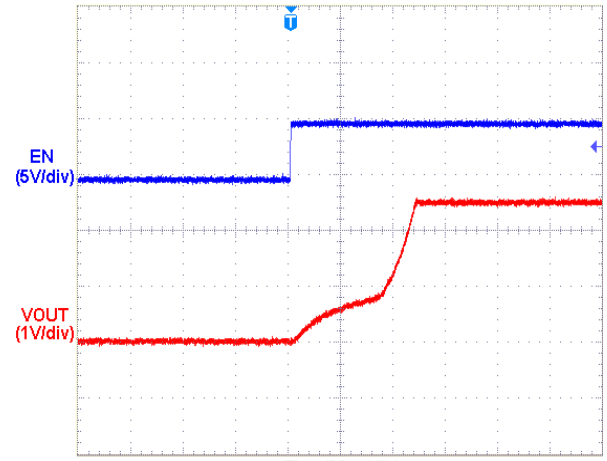

Time(20us/div)
 $V_{OUT}=2.5V, I_{OUT}=150mA, V_{DD}=3.5V$

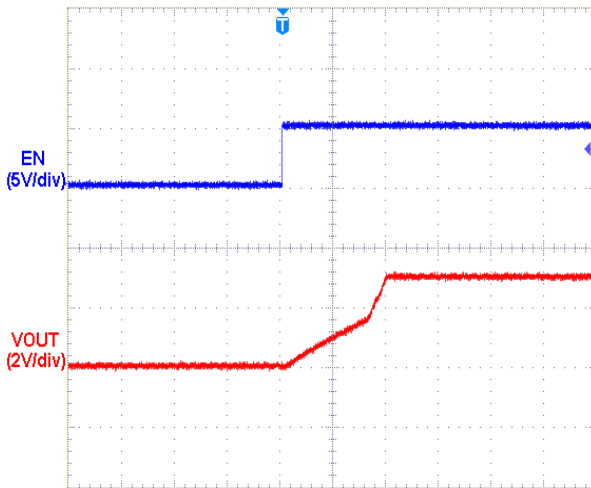

Time(20us/div)
 $V_{OUT}=3.0V, I_{OUT}=0mA, V_{DD}=4.0V$

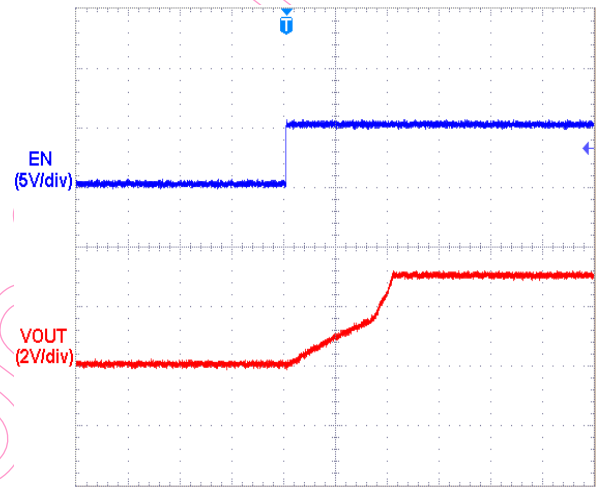

Time(20us/div)
 $V_{OUT}=3.0V, I_{OUT}=10mA, V_{DD}=4.0V$

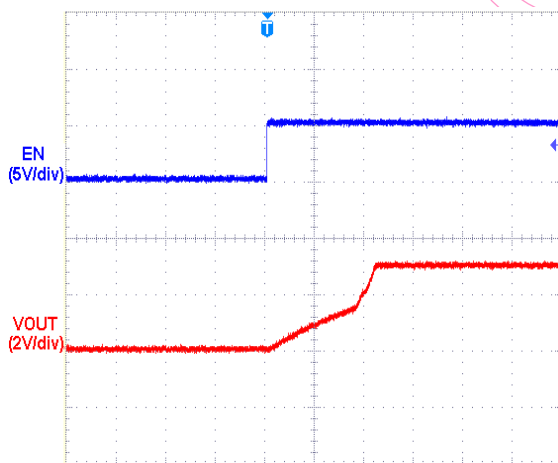

Time(20us/div)
 $V_{OUT}=3.0V, I_{OUT}=30mA, V_{DD}=4.0V$

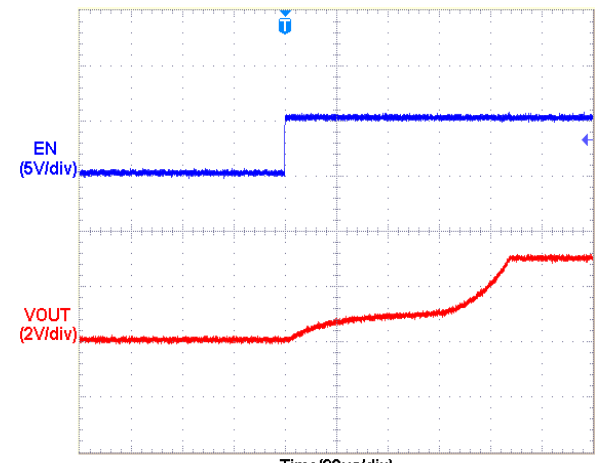

Time(20us/div)
 $V_{OUT}=3.0V, I_{OUT}=150mA, V_{DD}=4.0V$

Turn Off Speed with EN pin (Auto Discharge) (C_{in}=1.0uF, C_{out}=1.0uF, Temp=25°C)

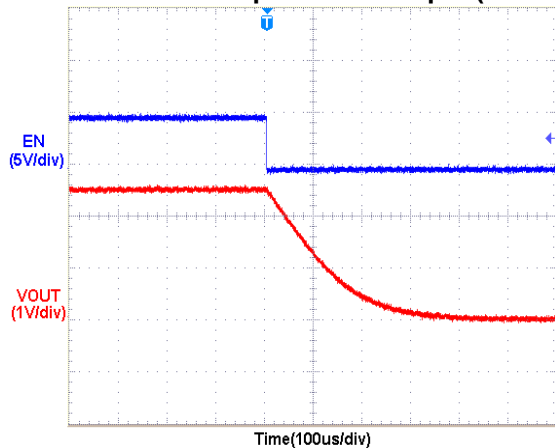

V_{OUT}=2.5V, I_{OUT}=0mA, V_{DD}=3.5V

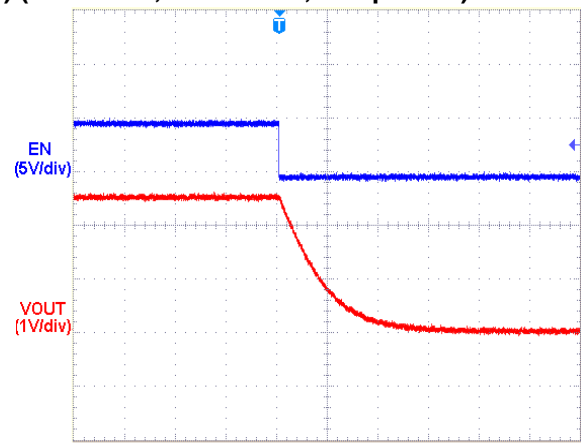

V_{OUT}=2.5V, I_{OUT}=10mA, V_{DD}=3.5V

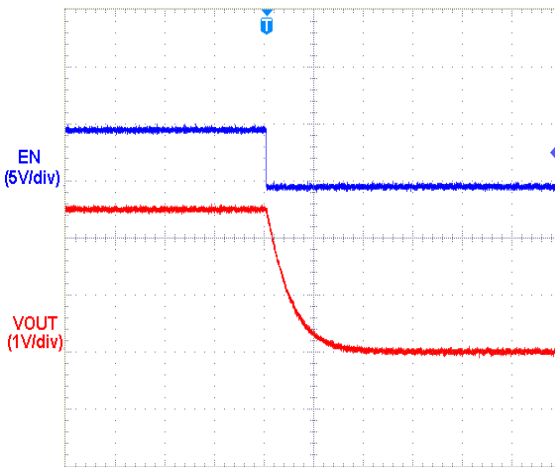

V_{OUT}=2.5V, I_{OUT}=30mA, V_{DD}=3.5V

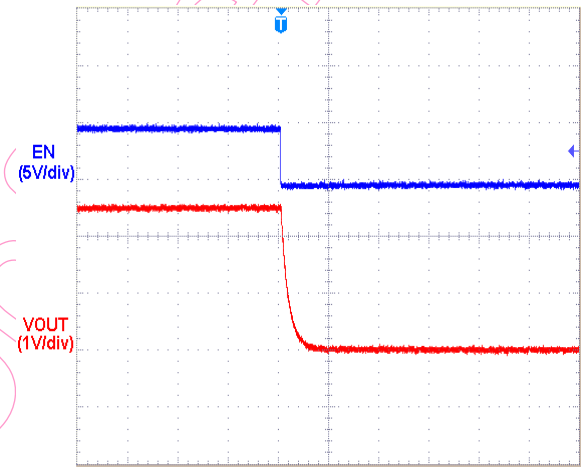

V_{OUT}=2.5V, I_{OUT}=150mA, V_{DD}=3.5V

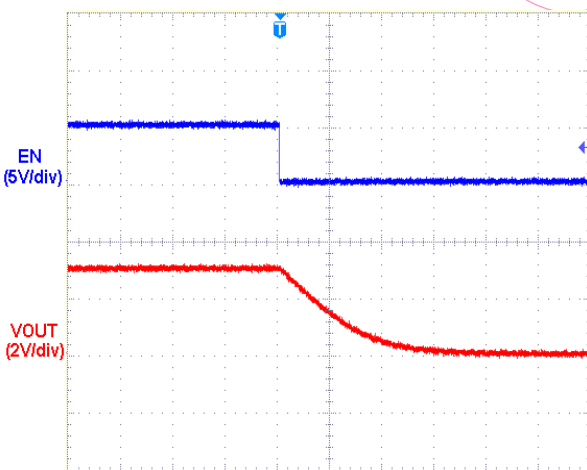

V_{OUT}=3.0V, I_{OUT}=0mA, V_{DD}=4.0V

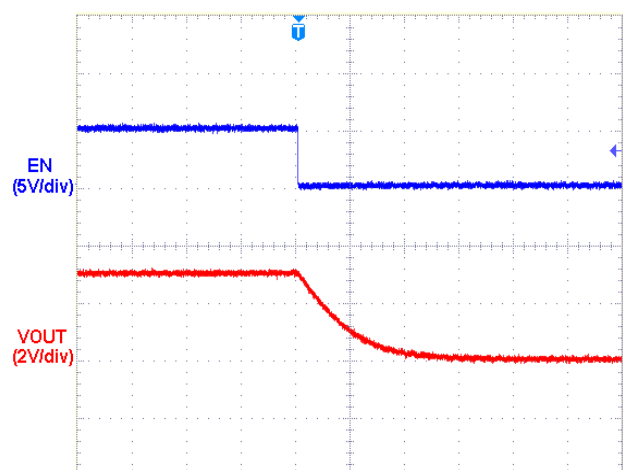

V_{OUT}=3.0V, I_{OUT}=10mA, V_{DD}=4.0V

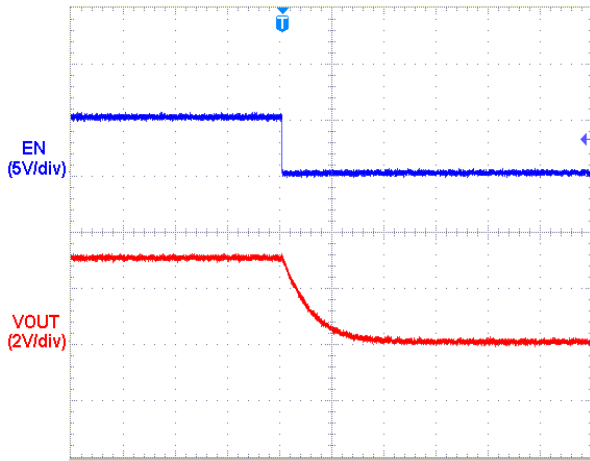

$V_{OUT}=3.0V$, $I_{OUT}=30mA$, $V_{DD}=4.0V$

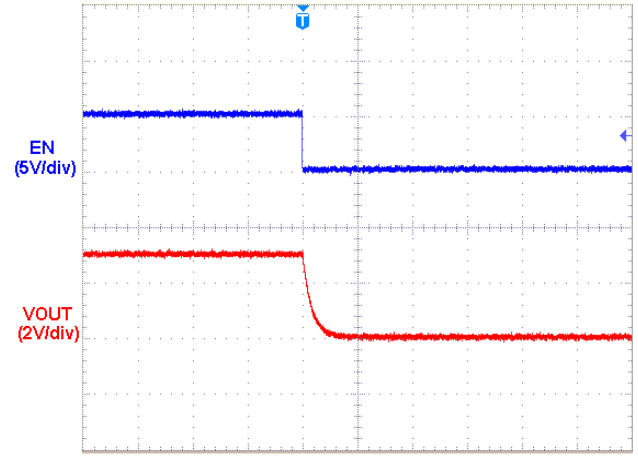

$V_{OUT}=3.0V$, $I_{OUT}=150mA$, $V_{DD}=4.0V$

GStek Confidential

Application Information

Enable

The GS7119 has a dedicated enable pin(EN). When the EN pin is in the logic low ($V_{EN}<0.3V$), the regulator will be turned off, reducing the supply current to less than 1uA.

When the EN pin is in the logic high ($V_{EN}>1.2V$), the regulator will be turned on. Left open, the EN pin is pulled down by a internal resistor to shut down the regulator.

Current Limit and Short circuit current protection

The GS7119 use a current mirror to monitor the output current. A small portion of the PMOS output transistor's current is mirrored onto a resistor such that the voltage across this resistor is proportional to the output current; this voltage is compared against the feedback voltage. Once the output current cannot exceeds the limit. The current is set to 480mA typically.

When the output voltage is less than 0.2V, the short circuit current protection starts and maintains the loading current to 40mA. The output can be shorted to ground without damaging the device.

Output Capacitor

The GS7119 is specifically designed to employ ceramic output capacitors as low as 1uF (X7R). The ceramic capacitors offer significant cost and space savings, along with high frequency noise filtering. Place the capacitors physically as close as possible to the device with wide and direct PCB traces.

Ceramic capacitors have different temperature characteristics and bias characteristics which depend on their dimensions and manufacturers. If

the setting voltage is 2.5V or more and the capacitor's dimensions for V_{OUT} equal to 1.0mm by 0.5mm or smaller than that, the capacitance value might be extremely low. As a result, the capacitance might be much less than expected value. In such cases, the operation might be unstable at low temperature (-25°C or less). In that case, use a larger capacity, or a large dimensions' capacitor. (For example 1.6mm by 0.8mm)

Input Capacitor

Good bypassing is recommended from input to ground to help improve AC performance. A 1uF (X7R) input capacitor or greater located as close as possible to the IC is recommended. Place the capacitors physically as close as possible to the device with wide and direct PCB traces.

Power Dissipation and Layout Considerations

Excessive power dissipation may cause thermal overload, and hence the increase of the IC junction temperature beyond a safe operating level. For continuous operation, it is highly recommended to keep the junction temperature below the maximum operation junction temperature 125°C for maximum reliability.

The relationship between θ_{JA} and $T_{J(MAX)}$ can be calculated as:

$$P_{D(MAX)} = (T_{J(MAX)} - T_A) / \theta_{JA}$$

Where $T_{J(MAX)}$ is the maximum operation junction temperature 125°C, T_A is the ambient temperature and the θ_{JA} is the junction to ambient thermal resistance.

The power dissipation definition in device is:

$$P_D = (V_{IN} - V_{OUT}) \times I_{OUT} + V_{DD} \times I_Q$$

As the above equations indicate, it is desirable to

work ICs whose θ_{JA} values are small such that $T_{J(MAX)}$ does not increase strongly with P_D . To avoid thermally overloading the GS7119, refrain from exceeding the absolute maximum junction temperature rating of 150°C under continuous operating condition. Overstressing the regulator with high loading currents and elevated input-to-output differential voltages can increase the IC die temperature significantly.

GStek Confidential

Package Dimensions, WDFN4-1.2x1.6

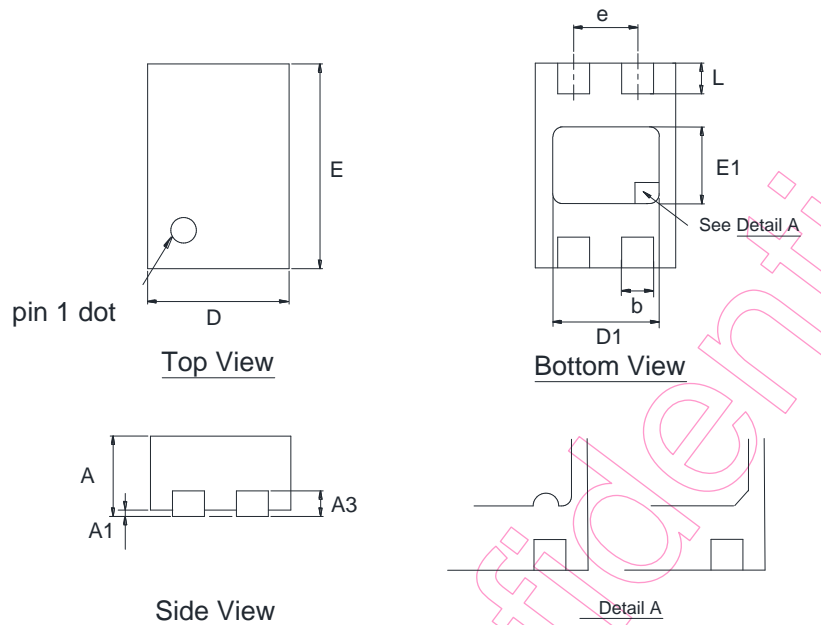

Pin #1 ID Options
 Note: The configuration of the Pin#1 identifier is optional, but must be located within the zone indicated.

Symbol	Dimensions in Millimeters	
	Min.	Max.
A	0.45	0.55
A1	0.00	0.05
A3	0.203 REF	
b	0.25	0.35
e	0.60 REF.	
D	1.15	1.25
E	1.55	1.65
D1	1.00 REF.	
E1	0.70 REF.	
L	0.25	0.35

Note

- 1.Min.: Minimum dimension specified.
- 2.Max.: Maximum dimension specified.
- 3.REF.: Reference. Normal/Regular dimension specified for reference.

Package Dimensions, TDFN6-1.8x2

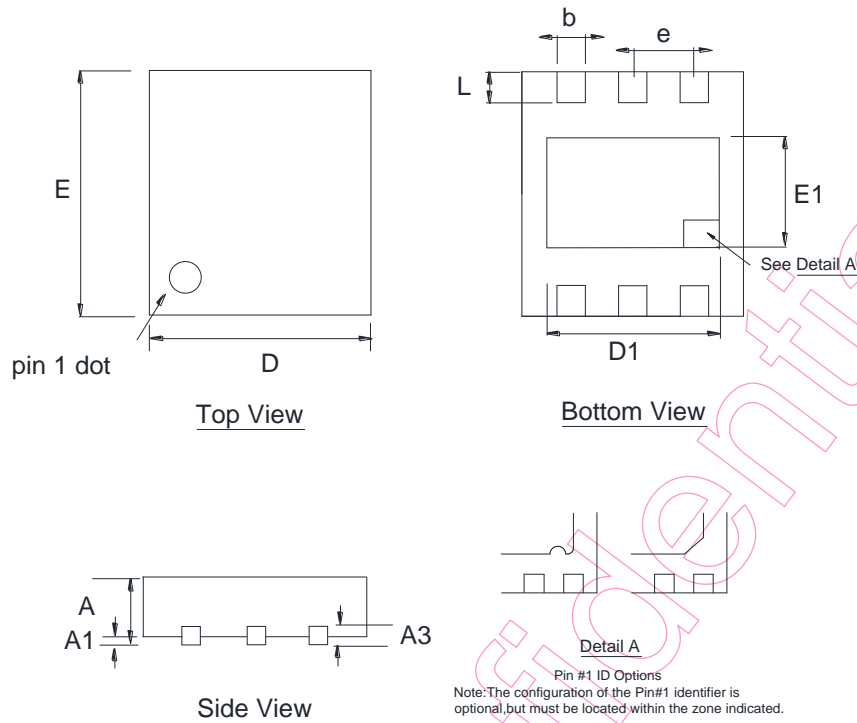

Symbol	Dimensions in Millimeters	
	Min.	Max.
A	0.45	0.60
A1	0.00	0.05
A3	0.15 REF.	
b	0.15	0.28
e	0.50 REF.	
D	1.70	1.90
E	1.90	2.10
D1	1.45 REF.	
E1	0.95 REF.	
L	0.17	0.33

Note:

1. Min.: Minimum dimension specified.
2. Max.: Maximum dimension specified.
3. REF.: Reference. Normal/Regular dimension specified for reference.

Package Dimensions, SOT-23-5

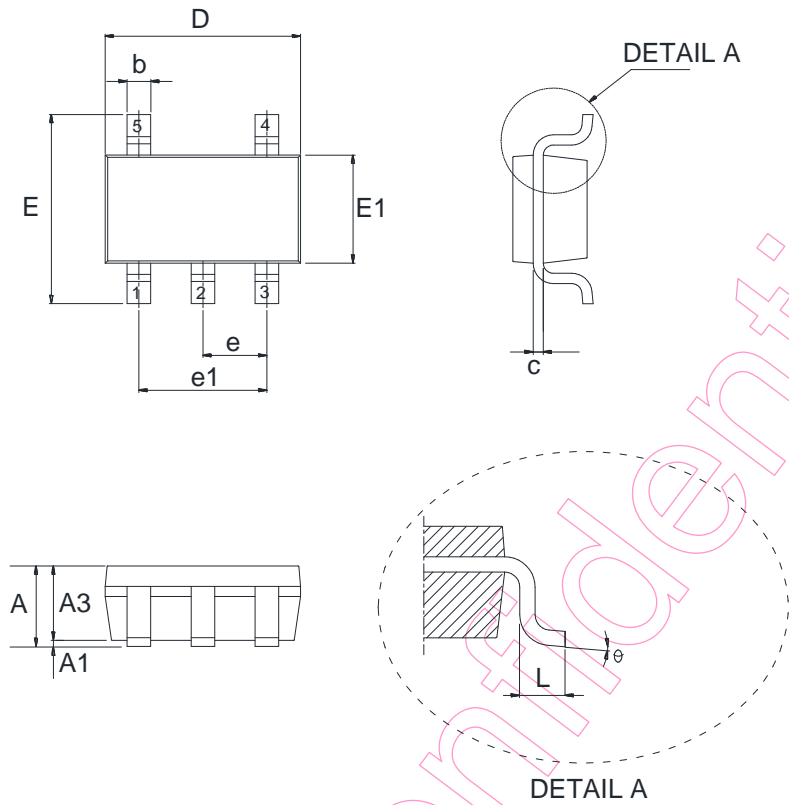

Symbol	Dimensions in Millimeters	
	Min.	Max.
A	0.90	1.45
A1	0.00	0.15
A3	0.90	1.30
b	0.30	0.50
c	0.08	0.25
e	0.95 REF.	
e1	1.90 REF.	
D	2.90 REF.	
E	2.80 REF.	
E1	1.60 REF.	
L	0.30	0.60
θ	0°	8°

Note

- 1.Min.: Minimum dimension specified.
- 2.Max.: Maximum dimension specified.
- 3.REF.: Reference. Normal/Regular dimension specified for reference.

Package Dimensions, SOT-89-3

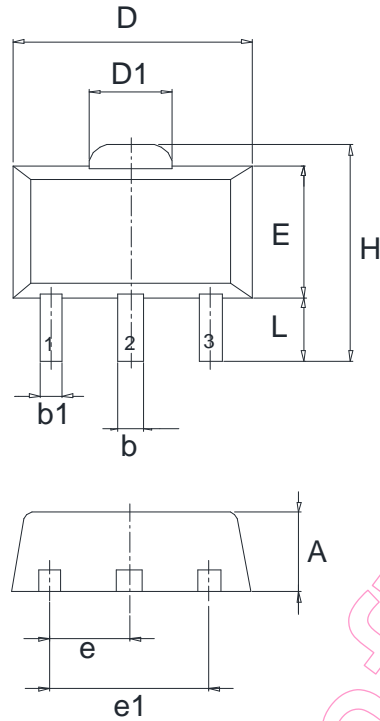

Symbol	Dimensions in Millimeters	
	Min.	Max.
A	1.40	1.60
b	0.40	0.58
b1	0.32	0.52
c	0.35	0.44
e	1.50 REF.	
e1	3.00 REF.	
D	4.40	4.60
D1	1.60 REF.	
E	2.29	2.60
H	3.94	4.25
L	0.80	1.20

Note

- 1.Min.: Minimum dimension specified.
- 2.Max.: Maximum dimension specified.
- 3.REF.: Reference. Normal/Regular dimension specified for reference.

Package Dimensions, MSOT-23

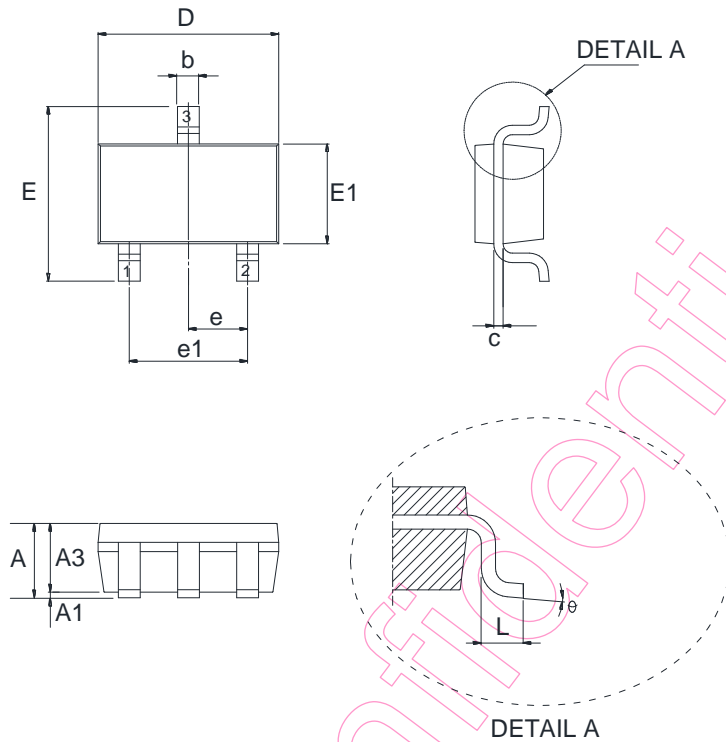

Symbol	Dimensions in Millimeters	
	Min.	Max.
A	0.90	1.15
A1	0.00	0.10
A2	0.90	1.05
b	0.30	0.50
c	0.08	0.15
e	0.95 REF.	
e1	1.90 REF.	
D	2.90 REF.	
E	2.40 REF.	
E1	1.30 REF.	
L	0.30	0.50
θ	0°	8°

Note:

1. Min.: Minimum dimension specified.
2. Max.: Maximum dimension specified.
3. REF.: Reference. Normal/Regular dimension specified for reference.

Package Dimensions, SOT-353(SC-75)

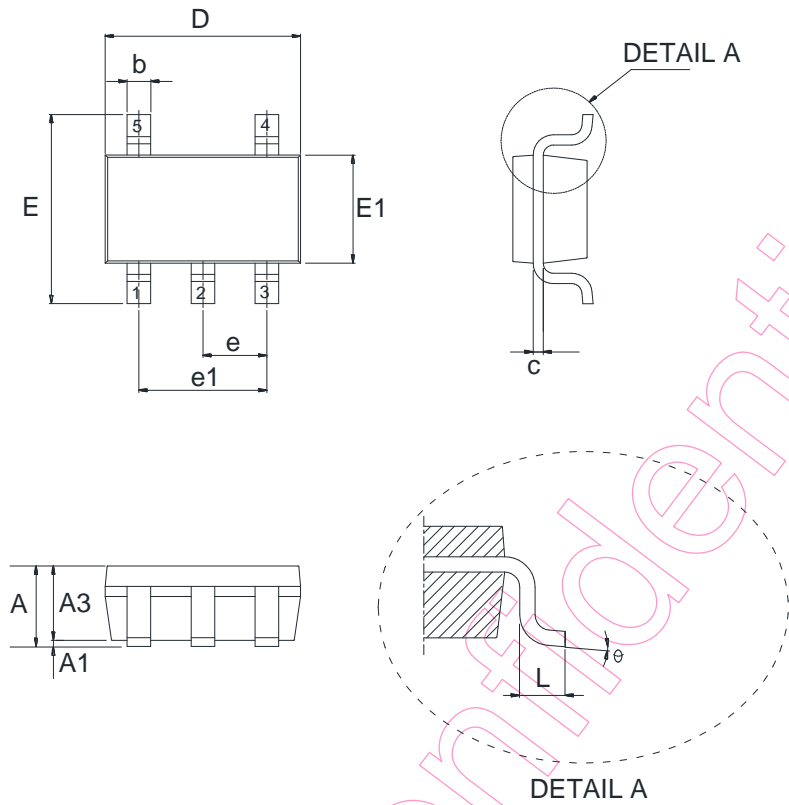

Symbol	Dimensions in Millimeters	
	Min.	Max.
A	0.85	1.10
A1	0.00	0.10
A3	0.80	1.00
b	0.15	0.35
c	0.08	0.15
e	0.65 REF.	
e1	1.30 REF.	
D	2.10 REF.	
E	2.30 REF.	
E1	1.25 REF.	
L	0.26	0.46
θ	0°	8°

Note

- 1.Min.: Minimum dimension specified.
- 2.Max.: Maximum dimension specified.
- 3.REF.: Reference. Normal/Regular dimension specified for reference.

DISCLAIMERS

Please read the notice stated in this preamble carefully before Admission e accessing any contents of the document attached. Admission of GStek's statement therein is presumed once the document is released to the receiver.

Notice:

Firstly, GREEN SOLUTION CO., LTD. (GStek) reserves the right to make corrections, modifications, enhancements, improvements, and other changes to its information herein without notice.. And the aforesaid information does not form any part or parts of any quotation or contract between GStek and the information receiver.

Further, no responsibility is assumed for the usage of the aforesaid information. GStek makes no representation that the interconnect of its circuits as described herein will not infringe on exiting or future patent rights and other intellectual property rights, nor do the descriptions contained herein express or imply that any licenses under any GStek patent right, copyright, mask work right, or other GStek intellectual property right relating to any combination, machine, or process in which GStek products or services are used.

Besides, the product in this document is not designed for use in life support appliances, devices, or systems where malfunction of this product can reasonably be expected to result in personal injury. GStek customers' using or selling this product for use in such applications shall do so at their own risk and agree to fully indemnify GStek for any damage resulting from such improper use or sale.

At last, the information furnished in this document is the property of GStek and shall be treated as highly confidentiality; any kind of distribution, disclosure, copying, transformation or use of whole or parts of this document without duly authorization from GStek by prior written consent is strictly prohibited. The receiver shall fully compensate GStek without any reservation for any losses thereof due to its violation of GStek's confidential request. The receiver is deemed to agree on GStek's confidential request therein suppose that said receiver receives this document without making any expressly opposition. In the condition that aforesaid opposition is made, the receiver shall return this document to GStek immediately without any delay.

X-ON Electronics

Largest Supplier of Electrical and Electronic Components

Click to view similar products for [LDO Voltage Regulators](#) category:

Click to view products by [GSTEK\(Green Solution Technology\)](#) manufacturer:

Other Similar products are found below :

[M38D29FFHP#U1](#) [702103A](#) [717726C](#) [742457H](#) [MP20051DN-LF-Z](#) [R5F111PGGFB#30](#) [AP7363-SP-13](#) [NCP103AMX285TCG](#)
[NCV8664CST33T3G](#) [NCV8752AMX28TCG](#) [L9454](#) [AP7362-HA-7](#) [LX13043CLD](#) [TCR3DF185,LM\(CT](#) [TCR3DF24,LM\(CT](#)
[TCR3DF285,LM\(CT](#) [TCR3DF31,LM\(CT](#) [TCR3DF45,LM\(CT](#) [TLF4949EJ](#) [L9708](#) [L970813TR](#) [030014BB](#) [059985X](#) [EAN61387601](#)
[EAN61573601](#) [NCP121AMX173TCG](#) [NCP4687DH15T1G](#) [NCV8703MX30TCG](#) [701326R](#) [702087BB](#) [755078E](#) [TCR2EN28,LF\(S](#)
[LM1117DT-1.8/NO](#) [LT1086CM#TRPBF](#) [AZ1085S2-1.5TRE1](#) [MAX15101EWL+T](#) [NCV8170AXV250T2G](#) [SCD337BTG](#)
[TCR3DF27,LM\(CT](#) [TCR3DF19,LM\(CT](#) [TCR3DF125,LM\(CT](#) [TCR2EN18,LF\(S](#) [MAX15103EWL+T](#) [TS2937CZ-5.0 C0](#) [MAX8878EUK30-](#)
[T](#) [MAX663CPA](#) [NCV4269CPD50R2G](#) [NCV8716MT30TBG](#) [AZ1117IH-1.2TRG1](#) [MP2013GQ-P](#)