

## Features

- Maximum 3A Low-Dropout Voltage Regulator
- Ultra Low Dropout Voltage  
Typically 240mV at 3A Output Current
- High Output Accuracy over Line, Load and Temperature
- Build-In Soft-Start
- Excellent startup under load from 0 to 3A
- Power-On-Reset Monitoring on Both  $V_{DD}$  and  $V_{IN}$  Pins
- Power-OK Output function
- Foldback over Current Protection and Thermal shutdown
- 0.1 $\mu$ A (typ) Shutdown Supply Current
- Low ESR Output Capacitor(Multi-layer Chip Capacitors (MLCC)) Applicable
- $V_{out}$  Pull Low Resistance when Disable
- PSOP-8 、 TDFN10-3x3
- Green Product (RoHS, Lead-Free, Halogen-Free Compliant)

## Applications

- Notebook PC Applications
- Motherboard Applications
- Low Voltage Logic Supplies
- Microprocessor and Chipset Supplies
- Graphic Cards
- Cordless phones

## General Description

The GS7166 can deliver up to 3A of output current with a typical dropout voltage of only 240mV using internal n-channel MOSFETs. The linear regulator uses a separate VDD supply to power the control circuitry and drive the Internal n-channel MOSFETs. The output voltage is adjustable from 0.8V to the voltage that is very close to  $V_{IN}$ .

The GS7166 allows the use of low-ESR ceramic capacitor as low as 10 $\mu$ F. Moreover the IC provides good performance on both line transient response and load transient response.

The GS7166 provides foldback over current limit and thermal shutdown to prevent the linear regulator from damage. Built-in soft-start minimizes stress on the input power source by reducing capacitive inrush current on start-up. During start-up, POK remain low until the output reaches 92% of its rating value.

The GS7166 is available in PSOP-8 、 TDFN10-3x3 package.

**Typical Application**

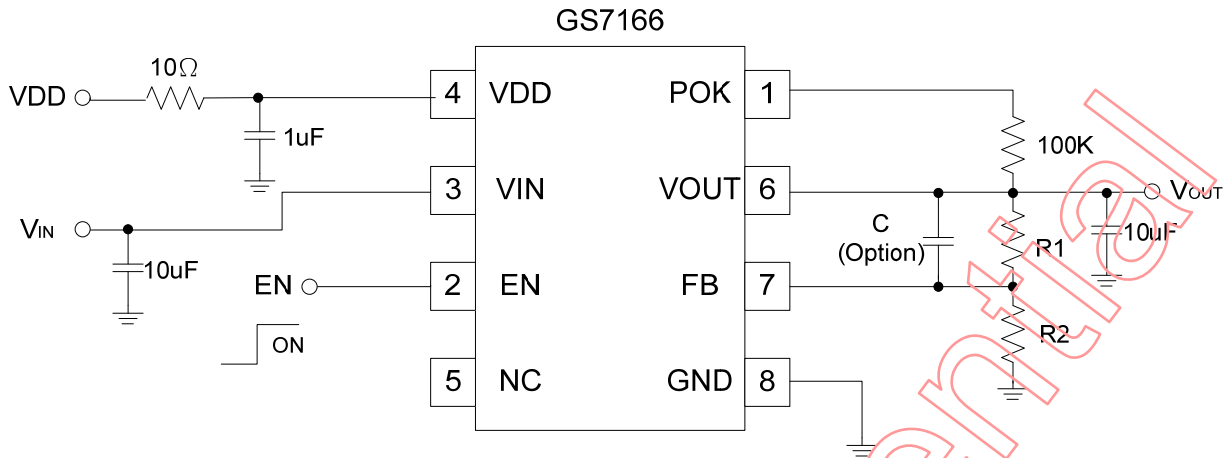

Figure 1 Typical application of GS7166

**Function Block Diagram**

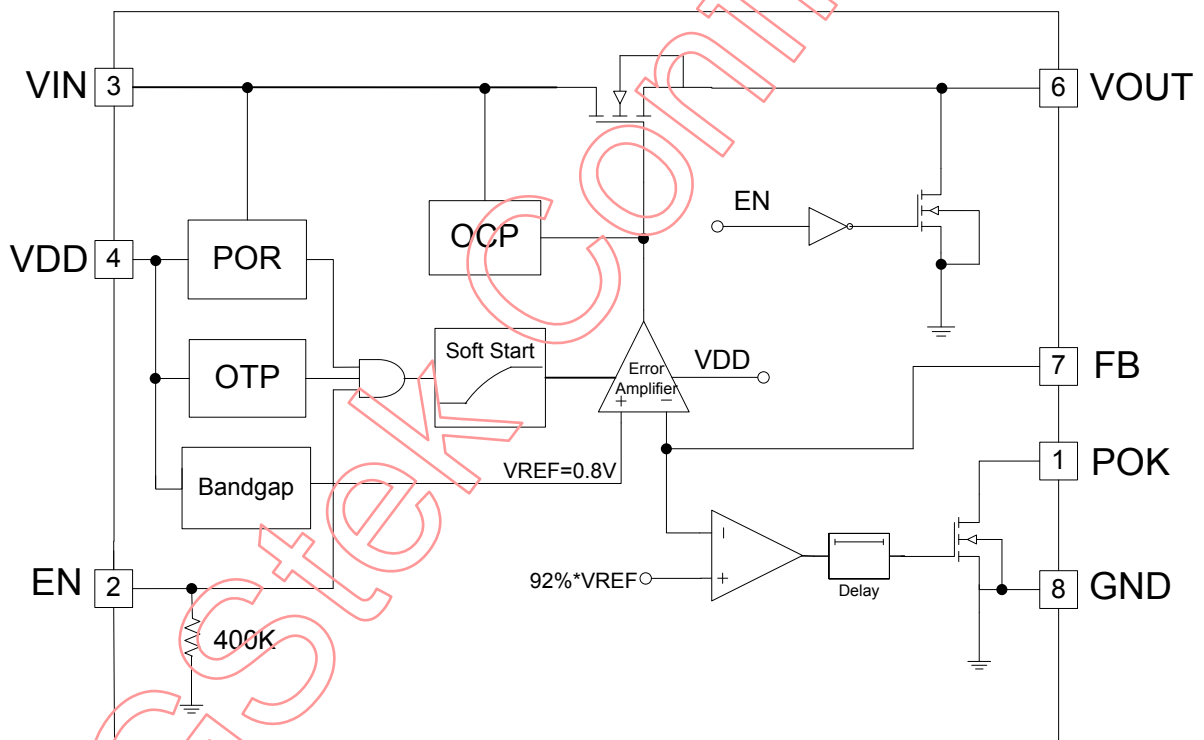

Figure 2 Function Block Diagram

**Pin Configuration**

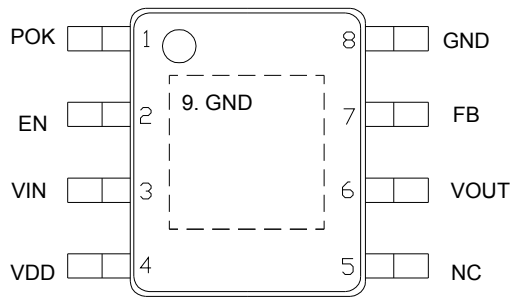

Figure 3a PSOP-8 package

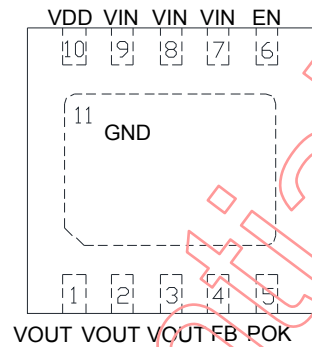
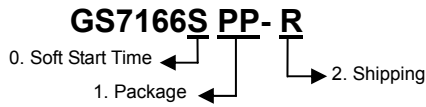

Figure 3b TDFN10-3x3 package

**Pin Descriptions**

Pin No.		Name	I/O type	Pin Function
PSOP-8	TDFN10-3x3			
1	5	POK	O	Open drain output. Setting high impedance once $V_{OUT}$ reaches 92% of its rating voltage
2	6	EN	I	Chip Enable (active high). The device will be shutdown if this pin is left open.
3	7,8,9	VIN	I	Input Voltage. Large bulk capacitance should be placed closely to this pin. A 10 $\mu$ F ceramic capacitor is recommended at this pin.
4	10	VDD	I	Supply voltage for control circuit, VDD is recommend from 3V to 5V and should be 1.5V higher than the output voltage
5		NC		Not connected
6	1,2,3	VOUT	O	Output Voltage. The power output of the device.
7	4	FB	I	Feedback Voltage. This pin is connected to the center tap of an external resistor divider network to set the output voltage as $V_{OUT} = 0.8(R1+R2)/R2$ .
8,9	11	GND	I	Ground.

**Ordering Information**



No	Item	Contents
0	Soft Start Time	Unmarked: Soft Start=1.5ms S: Soft Start=1ms
1	Package	SO: PSOP-8(B) TD: TDFN10-3x3
2	Shipping	R: Tape & Reel

Example: GS7166, Soft Start=1.5ms, PSOP-8(B) Tape & Reel ordering information is “GS7166SO-R”

**Absolute Maximum Rating (Note 1)**

Parameter	Symbol	Limits	Units
Supply Voltage	$V_{IN}$	$-0.3 < V_{IN} < 6$	V
Control Voltage	$V_{DD}$	$-0.3 < V_{DD} < 6$	V
Output Voltage	$V_{OUT}$	$-0.3 < V_{OUT} < 5$	V
EN, FB, POK		$-0.3 < (V_{EN}, V_{FB}, V_{POK}) < 6$	V
Package Power Dissipation at $T_A \leq 25^\circ\text{C}$	$P_{D\_PSOP-8}$	1333	mW
Package Power Dissipation at $T_A \leq 25^\circ\text{C}$	$P_{D\_TDFN10-3x3}$	1670	mW
Junction Temperature	$T_J$	- 45 ~ 150	$^\circ\text{C}$
Storage Temperature	$T_{STG}$	- 65 ~ 150	$^\circ\text{C}$
Lead Temperature (Soldering) 10S	$T_{LEAD}$	260	$^\circ\text{C}$
ESD (Human Body Mode) (Note 2)	$V_{ESD\_HBM}$	2K	V
ESD (Machine Mode) (Note 2)	$V_{ESD\_MM}$	200	V

**Thermal Information (Note 3)**

Parameter	Symbol	Limits	Units
Thermal Resistance Junction to Ambient	$\theta_{JA\_PSOP-8}$	75	$^\circ\text{C/W}$
Thermal Resistance Junction to Case	$\theta_{JC\_PSOP-8}$	12	$^\circ\text{C/W}$
Thermal Resistance Junction to Ambient	$\theta_{JA\_TDFN10-3x3}$	60	$^\circ\text{C/W}$
Thermal Resistance Junction to Case	$\theta_{JC\_TDFN10-3x3}$	5	$^\circ\text{C/W}$

**Recommend Operating Condition (Note 4)**

Parameter	Symbol	Limits	Units
Supply Voltage	$V_{IN}$	$1.0 < V_{IN} < \min\{5.2V, V_{DD}\}$	V
Control Voltage (Note 5)	$V_{DD}$	$3.0 < V_{DD} < 5.5$	V
Junction Temperature	$T_J$	-40 ~ 125	°C
Ambient Temperature	$T_A$	-40 ~ 85	°C

**Electrical Characteristics**

( $V_{IN} = V_{OUT} + 0.5V$ ,  $V_{EN} = V_{DD} = 5V$ ,  $C_{IN} = C_{OUT} = 10\mu F$ ,  $T_A = T_J = -40 \sim 125^\circ C$ )

Parameter	Symbol	Conditions	Min.	Typ.	Max.	Units
<b>Supply Voltage Section</b>						
$V_{DD}$ Operation Voltage Range	$V_{DD}$	$V_{DD}$ Input Range, $V_{OUT} = V_{REF}$	3.0		5.5	V
$V_{IN}$ Operation Voltage Range	$V_{IN}$	$V_{IN}$ Input Range, $V_{OUT} = V_{REF}$	1.0		$\min\{5.2V, V_{DD}\}$	V
Quiescent current	$I_Q$	$V_{DD} = V_{IN} = V_{EN} = 5V$ , $I_{OUT} = 0A$ , $V_{OUT} = V_{REF}$		1.0	1.5	mA
$V_{DD}$ Input current	$I_{VDD}$	$V_{DD} = V_{IN} = V_{EN} = 5V$ , $I_{OUT} = 0A$ , $V_{OUT} = V_{REF}$		1.0	1.5	mA
Control Input Current in Shutdown	$I_{VDD\_SD}$	$V_{DD} = V_{IN} = 5.0V$ , $I_{OUT} = 0A$ , $V_{EN} = 0V$		0.1	12	uA
$V_{DD}$ POR Threshold	$V_{DDRTH}$		2.4	2.7	3	V
$V_{DD}$ POR Hysteresis			0.15	0.2		V
$V_{IN}$ POR Threshold	$V_{INRTH}$		0.55	0.75	0.95	V
$V_{IN}$ POR Hysteresis			0.13	0.20		V
<b>Output Voltage</b>						
Reference Voltage	$V_{REF}$	$I_{OUT} = 1mA$ , $V_{OUT} = V_{REF}$	0.784	0.8	0.816	V
Output Voltage Accuracy			-2.0		+2.0	%
Line Regulation ( $V_{DD}$ )	$\Delta V_{LINE\_VDD}$	$V_{DD} = 4V$ to $5V$ , $I_{OUT} = 1mA$ , $V_{OUT} = V_{REF}$ , $V_{IN} = 2V$		0.03	0.2	%
Line Regulation ( $V_{IN}$ )	$\Delta V_{LINE\_IN}$	$V_{IN} = 1.2V$ to $5V$ , $I_{OUT} = 1mA$ , $V_{OUT} = V_{REF}$		0.01	0.1	%
Load Regulation (Note 6)	$\Delta V_{LOAD}$	$I_{OUT} = 1mA$ to $3A$ , $V_{OUT} = V_{REF}$		0.1	1.5	%
$V_{OUT}$ Pull Low Resistance		$V_{DD} = V_{IN} = 5.0V$ , $V_{EN} = 0V$		130		$\Omega$

Dropout Voltage						
Dropout Voltage (Note 7)	$V_{DROPO}$	$V_{OUT}=V_{REF}, I_{OUT}=2A$		160	300	mV
		$V_{OUT}=V_{REF}, I_{OUT}=3A$		240	380	mV
Protection						
Current Limit	$I_{LIM}$	$V_{DD}=V_{IN}=V_{EN}=5V, V_{OUT}=V_{REF}$		4		A
Short Circuit Current	$I_{FOLDBACK}$	$V_{OUT}<0.2V$		100		mA
Thermal Shutdown Temperature	$T_{SD}$	$T_J$ Rising		170		°C
Thermal Shutdown Returned Temperature				120		°C
Enable						
EN Threshold	Logic-Low Voltage	$V_{DD}=5V$			0.6	V
	Logic-High Voltage	$V_{DD}=5V$	1.2			V
EN Input Bias Current	$I_{EN}$	$V_{EN}=5V$		12	20	uA
Power Good						
PGOOD Rising Threshold		$V_{REF}$ Rising		92		%
PGOOD Hysteresis		$V_{REF}$ falling		8		%
PGOOD Sink Capability		$I_{PGOOD}=1mA$		0.2	0.4	V
PGOOD Delay		-40°C ~125°C		1.7		mS

**Note 1.** Stresses listed as the above “Absolute Maximum Ratings” may cause permanent damage to the device. These are for stress ratings. Functional operation of the device at these or any other conditions beyond those indicated in the operational sections of the specifications is not implied. Exposure to absolute maximum rating conditions for extended periods may remain possibility to affect device reliability.

**Note 2.** Devices are ESD sensitive. Handling precaution recommended.

**Note 3.**  $\theta_{JA}$  is measured in the natural convection at  $T_A=25^\circ C$  on a high effective thermal conductivity test board (4 Layers, 2S2P) of JEDEC 51-7 thermal measurement standard. The case point of  $\theta_{JC}$  is on the expose pad for PSOP-8 package.

**Note 4.** The device is not guaranteed to function outside its operating conditions.

**Note 5.**  $V_{DD}$  should be 1.5V higher than the output voltage,  $V_{DD}> 1.5V+V_{out}$

**Note 6.** Regulation is measured at constant junction temperature by using a 2ms current pulse. Devices are tested for load regulation in the load range from 1mA to 3A.

**Note 7.** The Dropout voltage is defined as  $V_{IN}-V_{OUT}$ , which is measured when  $V_{OUT}$  is  $0.98*V_{OUT(NORMAL)}$ . The dropout voltage is measured at constant junction temperature by using a 2ms current pulse.

Typical Characteristics

V<sub>IN</sub> Line Transient Response

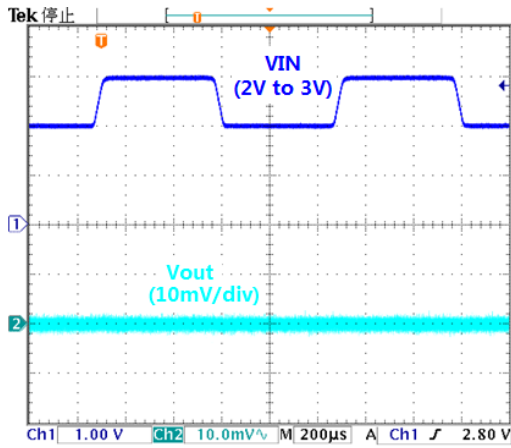

V<sub>OUT</sub>=1.2V, I<sub>OUT</sub>=0A

V<sub>IN</sub> Line Transient Response

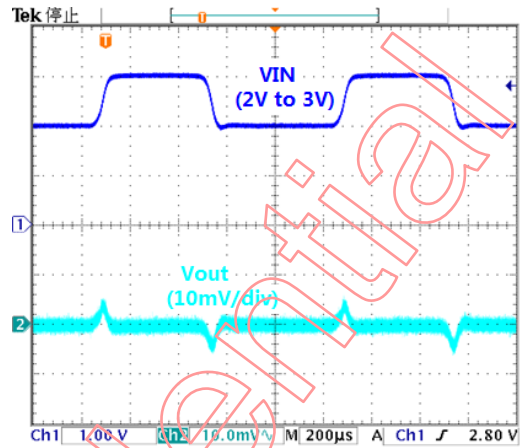

V<sub>OUT</sub>=1.2V, I<sub>OUT</sub>=1A

V<sub>DD</sub> Line Transient Response

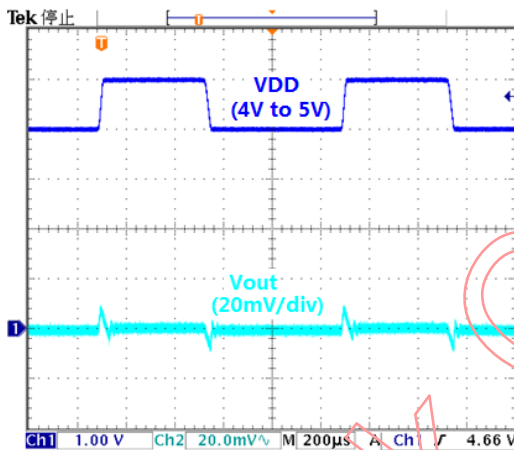

V<sub>OUT</sub>=1.2V, I<sub>OUT</sub>=1mA

V<sub>DD</sub> Line Transient Response

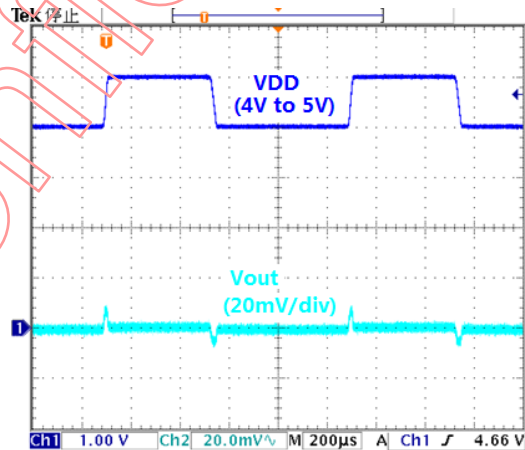

V<sub>OUT</sub>=1.2V, I<sub>OUT</sub>=1A

Load Transient Response

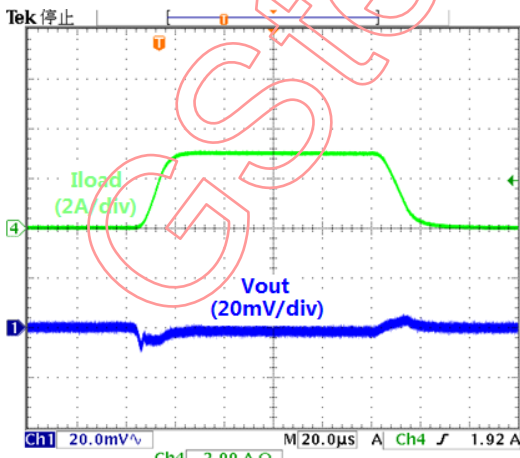

V<sub>OUT</sub>=1.2V, C<sub>OUT</sub>=10µF

Power On from VIN

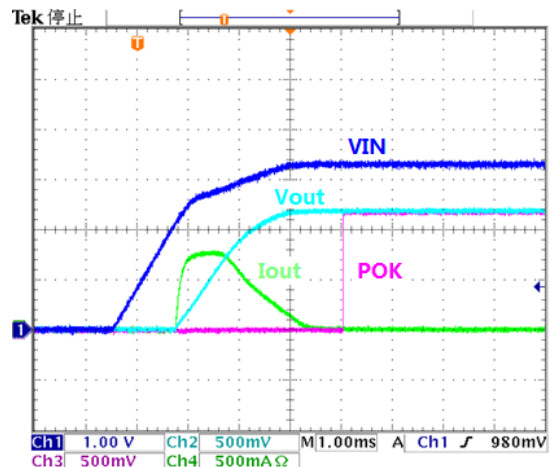

V<sub>DD</sub>=5V, V<sub>OUT</sub>=1.2V, C<sub>OUT</sub>=1000µF+10µF, no load



### Power On from V<sub>DD</sub>

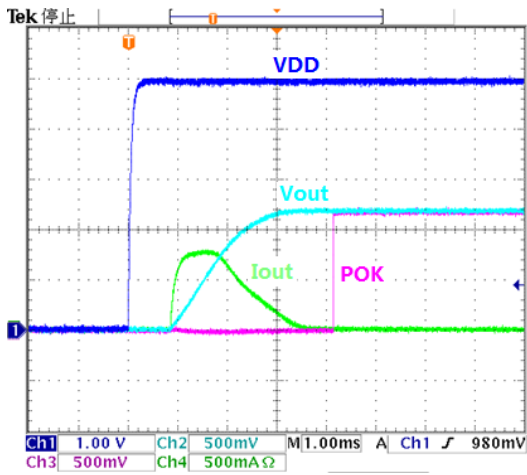

V<sub>DD</sub>=5V, V<sub>OUT</sub>=1.2V, C<sub>OUT</sub>=1000uF+10uF, no load

### Turn On from EN

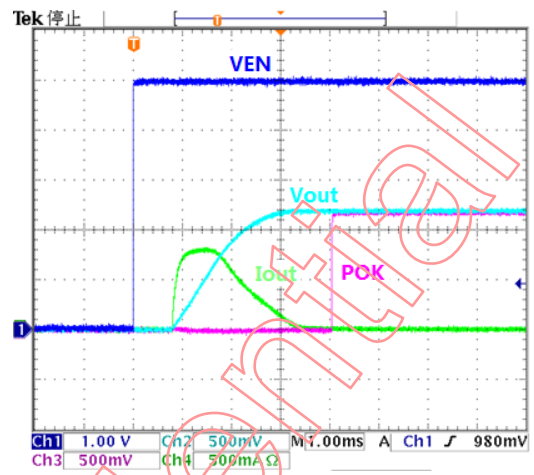

V<sub>EN</sub>=5V, V<sub>OUT</sub>=1.2V, C<sub>OUT</sub>=1000uF+10uF, no load

### Turn On from EN

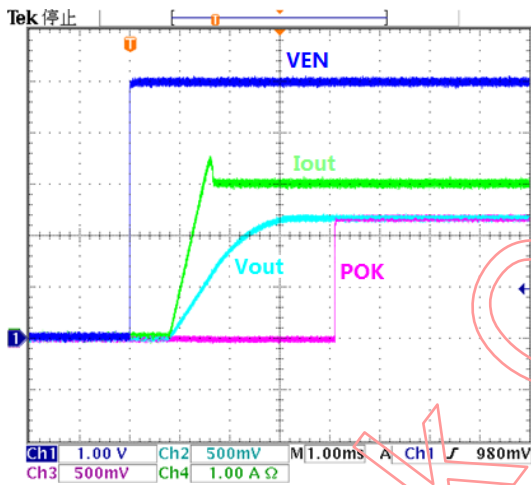

V<sub>EN</sub>=5V, V<sub>OUT</sub>=1.2V, C<sub>OUT</sub>=10uF, I<sub>load</sub>=3A

### Turn On from EN

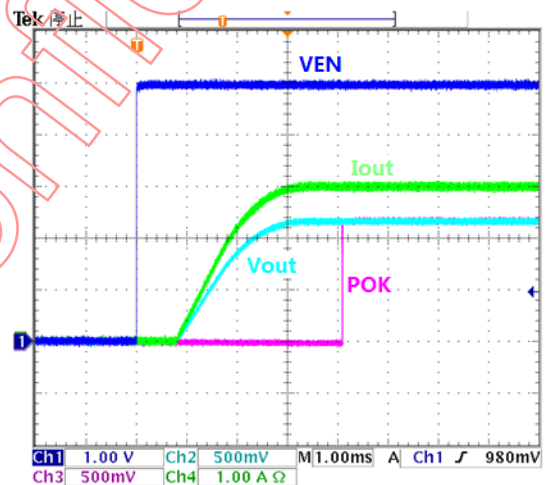

V<sub>EN</sub>=5V, V<sub>OUT</sub>=1.2V, C<sub>OUT</sub>=10uF, R<sub>load</sub>=0.4Ω

### Output Short Current

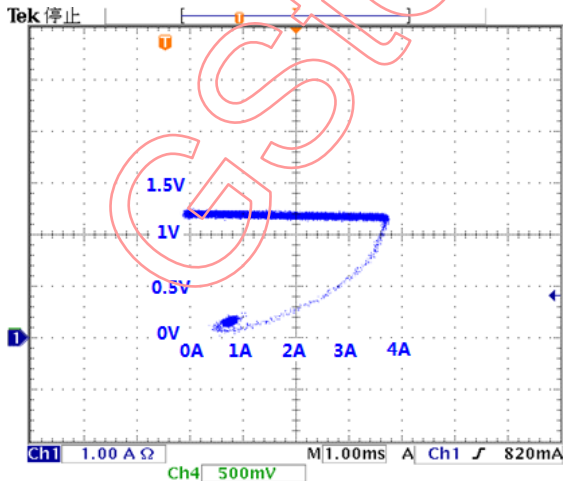

### Output Current Protection

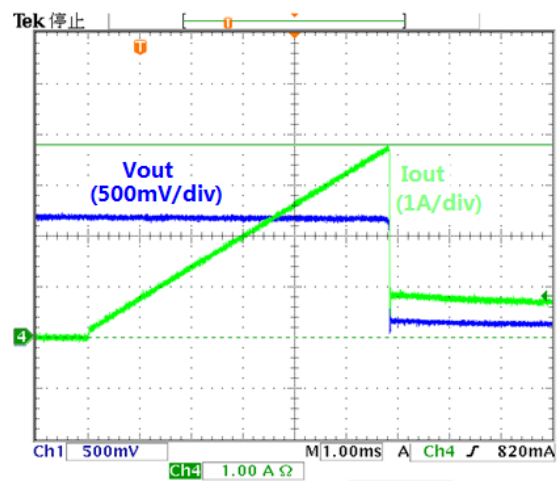



**Dropout Voltage vs. Output Current**

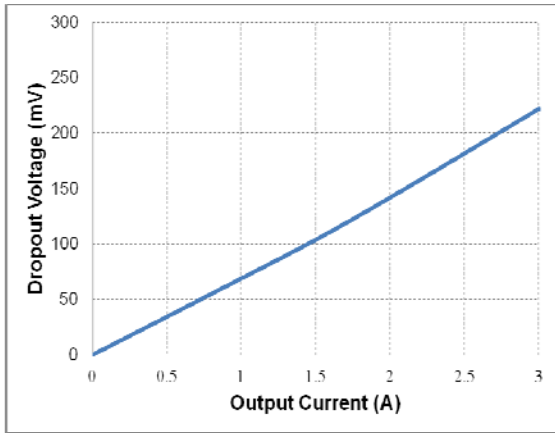

**Shutdown Current vs. Input Voltage**

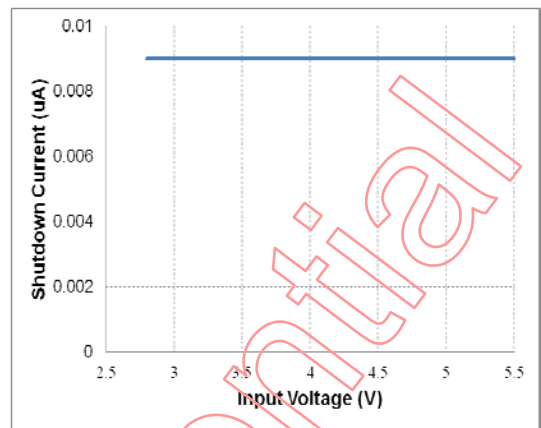

**Quiescent Current vs. Input Voltage**

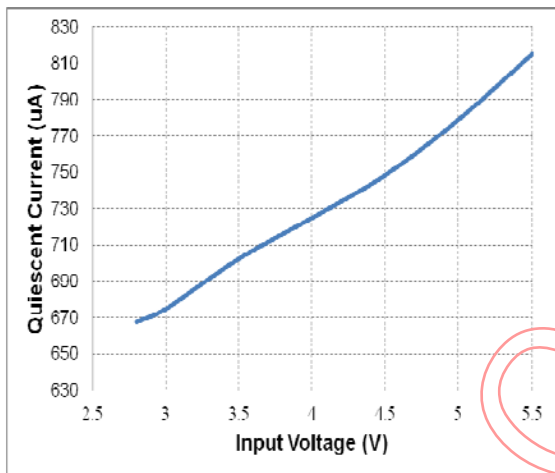

**Dropout Voltage vs. Temperature**

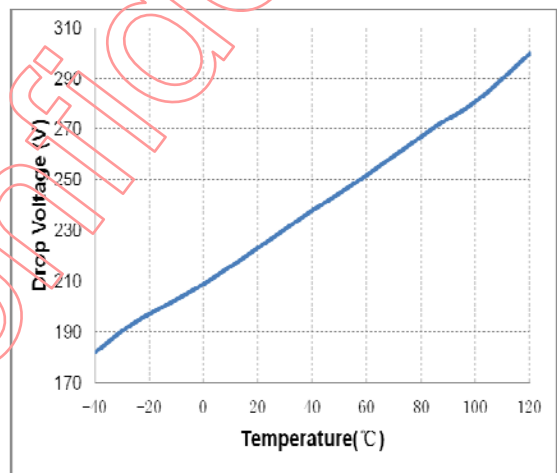

**Quiescent Current vs. Temperature**

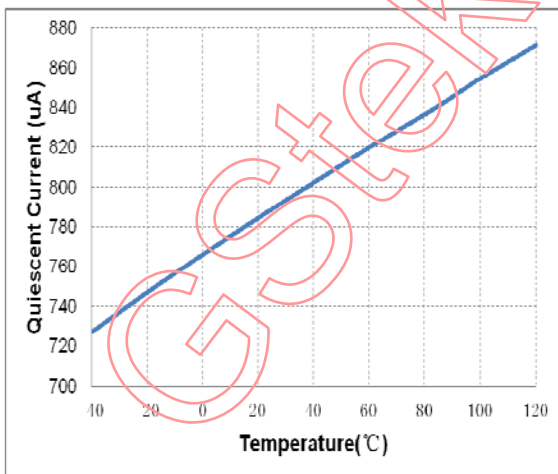

**Output Voltage vs. Temperature**

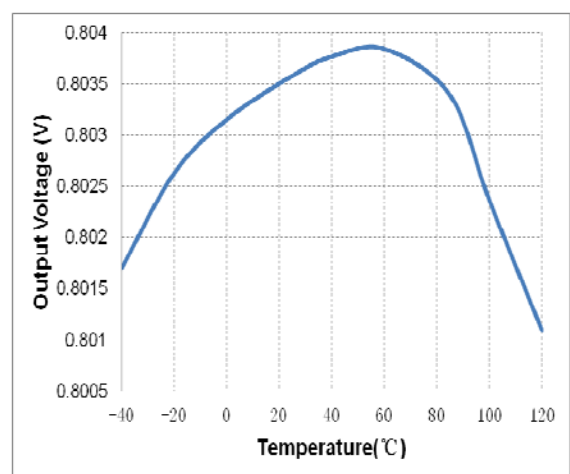

## Application Information

### Enable

The GS7166 has a dedicated enable pin(EN). When the EN pin is in the logic low ( $V_{EN}<0.6V$ ), the regulator will be turned off, reducing the supply current to less than 1 $\mu$ A.

When the EN pin is in the logic high ( $V_{EN}>1.2V$ ), the regulator will be turned on and undergoes a new soft-start cycle. Left open, the EN pin is pulled down by a internal resistor to shut down the regulator.

### Power-on-Reset

The GS7166 features a power-on-reset control through monitor both input voltages to prevent wrong operations. Only after the two supply voltages exceed their rising POR threshold voltages, the regulator is to be initiated and starts up.

### POK

The POK pin is an open-drain output, and can be connects to  $V_{OUT}$  or other rail through an external pull-up resistor. As the output voltage arrives 92% of normal output voltage, an internal delay function starts to perform a delay time and then output the POK pin high to indicate the output is OK. As the output voltage falls below the falling Power-OK threshold or one of the two supply voltages falls below its falling POR threshold, the POK pin will output low immediately without a delay time.

### Build-In Soft-Start

An internal soft-start function controls rise rate of the output voltage to limit the current surge at start-up. The typical soft-start interval is about 1.5mS/1.0mS.

### Current Limit

The GS7166 contains a foldback over current protection function. It allows the output current to reach the value of 4A. Then further decreases in the load resistance reduce both the load current and the load voltage. The main advantage of foldback limiting is less power dissipation in the pass transistor under shorted-load conditions. During startup, the current limit value is set to a high value, thus GS7166 can operate in full load condition. After startup, the current limit value is set to a normal value, so the pass transistor can be protected well.

### Thermal-Shutdown Protection

Thermal Shutdown protects GS7166 from excessive power dissipation. If the die temperature exceeds 170°C, the pass transistor is shut off. 50°C of hysteresis prevents the regulator from turning on until the die temperature drops to 120°C.

### Output Capacitor selection

The GS7166 is specifically designed to employ ceramic output capacitors as low as 10 $\mu$ F. Place the capacitors physically as close as possible to the device with wide and direct PCB traces. Capacitor ESR should be less than 50mohm.

### Feedback Network

Figure 4 shows the feedback network. For Coption NC application, the suggested design procedure is to choose  $R2=100K\Omega$ .

$V_{OUT}$	$R1(R2=100K\Omega)$	$C_{OPTION}$
0.8V ~ 3.6V	0 ~ 300 K $\Omega$	NC

Table 1.  $R2=100K\Omega$

For  $R2>10K\Omega$  application, the suggested design procedure is to choose table 2.

V <sub>OUT</sub>	R1(R2=10KΩ)	C <sub>OPTION</sub>
0.8V ~ 1.6V	0 ~ 10 KΩ	470pF~1nF
1.6V ~ 2.4V	10 KΩ ~ 20 KΩ	100pF~500pF
2.4V ~ 3.6V	20 KΩ ~ 30 KΩ	20pF~300pF

Table 2. R2=10KΩ

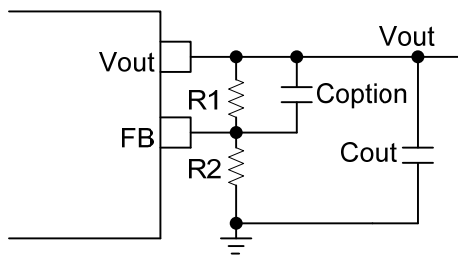

Figure 4 Feedback Network

**Input Capacitor selection**

Bypass VIN to ground with a 10uF or greater capacitor. Bypass VDD to ground with a 1uF capacitor for normal operation in most applications. Ceramic, tantalum or aluminum electrolytic capacitors may be selected for input capacitor. However ceramic capacitors are recommended due to their significant cost and space savings. Place the capacitors physically as close as possible to the device with wide and direct PCB traces.

**Power Dissipation and Layout Considerations**

Although internal thermal limiting function is integrated in GS7166, continuously keeping the junction near the thermal shutdown temperature may possibly affect device reliability. For continuous operation, it is highly recommended to keep the junction temperature below the maximum operation junction temperature 125°C for maximum reliability.

The power dissipation definition in device is:

$$P_D = (V_{IN} - V_{OUT}) \times I_{OUT} + V_{DD} \times I_Q$$

The maximum power dissipation can be calculated as:

$$P_{D(MAX)} = (T_{J(MAX)} - T_A) / \theta_{JA}$$

Where T<sub>J(MAX)</sub> is the maximum operation junction temperature 125°C, T<sub>A</sub> is the ambient temperature and the θ<sub>JA</sub> is the junction to ambient thermal resistance.

The thermal resistance θ<sub>JA</sub> for PSOP-8 package is 75°C/W on the standard JEDEC 51-7 (4 layers, 2S2P) thermal test board. The copper thickness is 2oz. The maximum power dissipation at T<sub>A</sub> = 25°C can be calculated by following formula:

$$P_{D(MAX)} = (125°C - 25°C) / (75°C/W) = 1.33W$$

(SOP-8 Exposed Pad on the minimum layout)

The thermal resistance θ<sub>JA</sub> of PSOP-8 is determined by the package design and the PCB design. Copper plane under the exposed pad is an effective heat sink and is useful for improving thermal conductivity. As shown in Figure 5, the amount of copper area to which the PSOP-8 is mounted affects thermal performance. When mounted to the standard PSOP-8 pad (Figure 5.a), θ<sub>JA</sub> is 75°C/W. Adding copper area of pad under the PSOP-8 (Figure 5.b) reduces the θ<sub>JA</sub> to 54°C/W. Even further, increasing the copper area of pad to 70mm<sup>2</sup> (Figure 5.c) reduces the θ<sub>JA</sub> to 49°C/W.

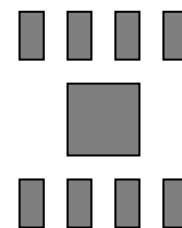

Figure 5 (a). Minimum Footprint, θ<sub>JA</sub> = 75°C/W

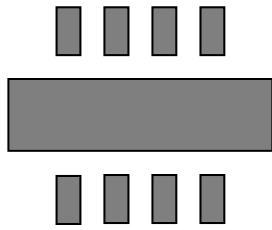

Figure 5 (b). Copper Area = 30mm<sup>2</sup>,  $\theta_{JA}$  = 54°C/W

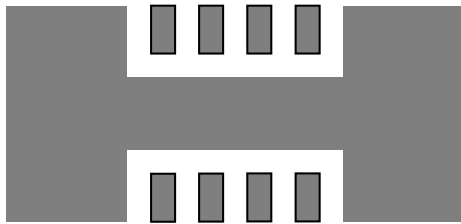

Figure 5 (c). Copper Area = 70mm<sup>2</sup>,  $\theta_{JA}$  = 49°C/W

Figure 5.  $\theta_{JA}$  vs. Different Cooper Area Layout Design

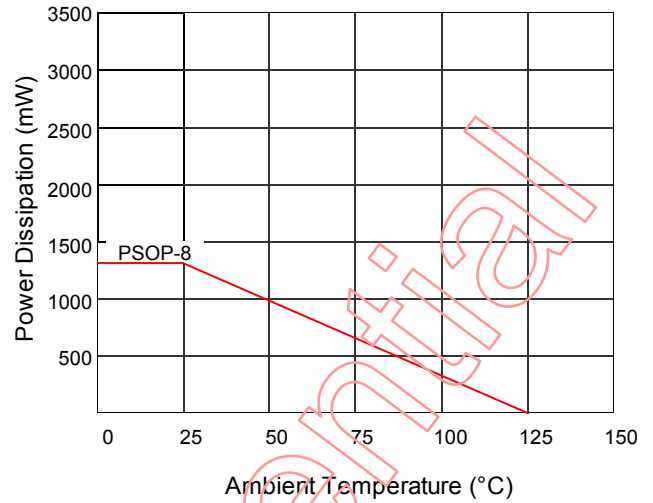

Figure 7 Derating Curve for Packages

And Figure 6 shows a curve for the  $\theta_{JA}$  of the PSOP-8 package for different copper area sizes using a typical PCB with 2oz copper in still air.

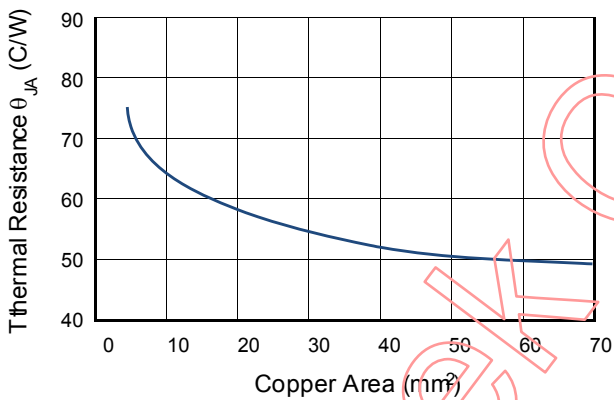
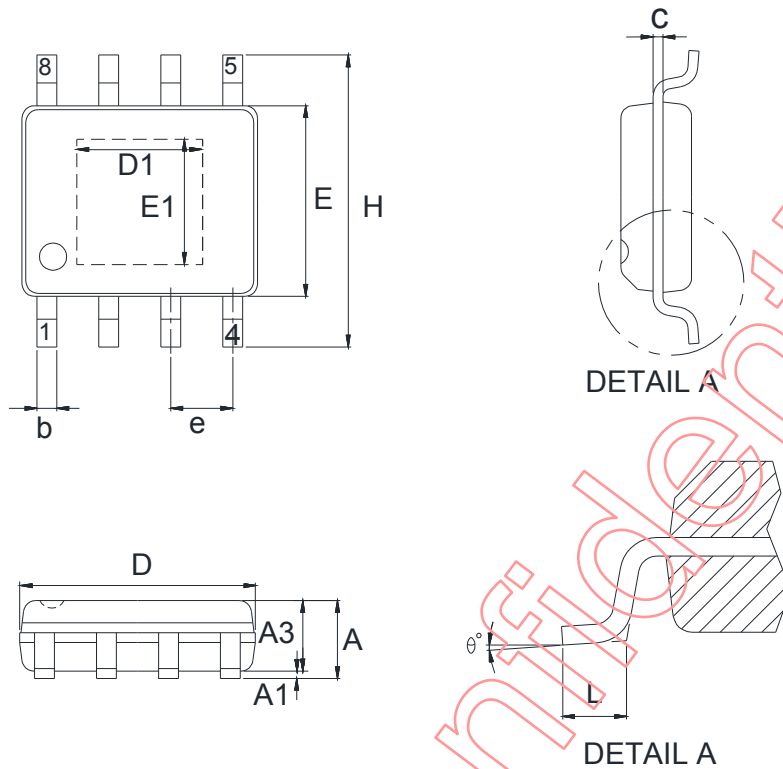

Figure 6  $\theta_{JA}$  vs. Copper Area

The maximum power dissipation depends on operating ambient temperature or fixed  $T_{J(MAX)}$  and thermal resistance  $\theta_{JA}$ . For GS7166 packages, the Figure 7 of derating curves allows the designer to see the effect of rising ambient temperature on the maximum power allowed.

**Package Dimensions, PSOP-8(B)**



Symbol	Dimensions in Millimeters	
	Min.	Max.
A	1.30	1.80
A1	-	0.15
A3	1.25	-
b	0.31	0.51
c	0.17	0.25
e	1.27 REF.	
D	4.70	5.10
E	3.80	4.00
D1	3.1 REF.	
E1	2.3 REF.	
H	5.80	6.20
L	0.40	1.27
θ	0°	8°

Note:

1. Min.: Minimum dimension specified.
2. Max.: Maximum dimension specified.
3. REF.: Reference. Normal/Regular dimension specified for reference.

**Package Dimensions, TDFN10-3x3**

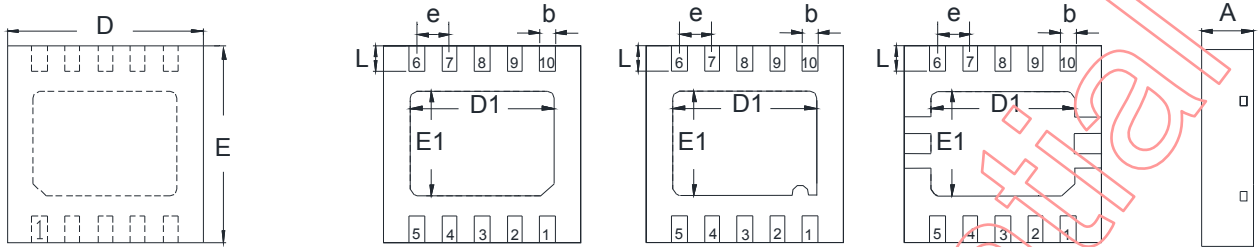

Top view

Bottom view

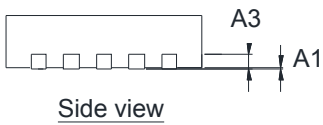

Side view

Pin #1 ID Options

Note: The configuration of the Pin#1 identifier is optional, but must be located within the zone indicated.

Symbol	Dimensions in Millimeters	
	Min.	Max.
A	0.70	0.80
A1	0.00	0.05
A3	0.203 REF.	
b	0.18	0.30
e	0.50 REF.	
D	2.90	3.10
E	2.90	3.10
D1	2.30 REF.	
E1	1.65 REF.	
L	0.30	0.50

**Note:**

1. Min.: Minimum dimension specified.
2. Max.: Maximum dimension specified.
3. REF.: Reference. Normal/Regular dimension specified for reference.

**DISCLAIMERS**

**Please read the notice stated in this preamble carefully before Admission e accessing any contents of the document attached. Admission of GStek's statement therein is presumed once the document is released to the receiver.**

Notice:

*Firstly, GREEN SOLUTION CO., LTD. (GStek) reserves the right to make corrections, modifications, enhancements, improvements, and other changes to its information herein without notice. And the aforesaid information does not form any part or parts of any quotation or contract between GStek and the information receiver.*

*Further, no responsibility is assumed for the usage of the aforesaid information. GStek makes no representation that the interconnect of its circuits as described herein will not infringe on exiting or future patent rights and other intellectual property rights, nor do the descriptions contained herein express or imply that any licenses under any GStek patent right, copyright, mask work right, or other GStek intellectual property right relating to any combination, machine, or process in which GStek products or services are used.*

*Besides, the product in this document is not designed for use in life support appliances, devices, or systems where malfunction of this product can reasonably be expected to result in personal injury. GStek customers' using or selling this product for use in such applications shall do so at their own risk and agree to fully indemnify GStek for any damage resulting from such improper use or sale.*

*At last, the information furnished in this document is the property of GStek and shall be treated as highly confidentiality; any kind of distribution, disclosure, copying, transformation or use of whole or parts of this document without duly authorization from GStek by prior written consent is strictly prohibited. The receiver shall fully compensate GStek without any reservation for any losses thereof due to its violation of GStek's confidential request. The receiver is deemed to agree on GStek's confidential request therein suppose that said receiver receives this document without making any expressly opposition. In the condition that aforesaid opposition is made, the receiver shall return this document to GStek immediately without any delay.*



## Product Marking Illustration

Product Name	GS7166SO-R	Control No.	MK-7166-SO8E-0-G-C
		Date	2013/11/27
Package Type	PSOP-8	Marking Type	Laser
Marking Location	Top side	Marking Font	Arial



Note:

1. Laser fonts example:

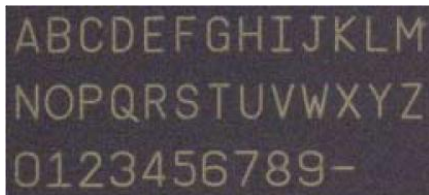

GStek	Fixed Code	D	Week Code
XXXXXX	Lot No.	NA	NA
Z	Control Code (A-Z or <u>A-Z</u> or 0~9 or <u>0~9</u> )		
M	Manufacture Code (A-Z or <u>A-Z</u> or 0~9 or <u>0~9</u> )		



## Date Code 對照表 Week Code (D)

D 編碼規則說明：D 為週碼。

例：第 5 週編碼為：E

### D 週碼編碼規則

週數	Code	週數	Code	週數	Code	週數	Code
01	A	14	N	27	<u>A</u>	40	<u>N</u>
02	B	15	O	28	<u>B</u>	41	<u>O</u>
03	C	16	P	29	<u>C</u>	42	<u>P</u>
04	D	17	Q	30	<u>D</u>	43	<u>Q</u>
05	E	18	R	31	<u>E</u>	44	<u>R</u>
06	F	19	S	32	<u>F</u>	45	<u>S</u>
07	G	20	T	33	<u>G</u>	46	<u>T</u>
08	H	21	U	34	<u>H</u>	47	<u>U</u>
09	I	22	V	35	<u>I</u>	48	<u>V</u>
10	J	23	W	36	<u>J</u>	49	<u>W</u>
11	K	24	X	37	<u>K</u>	50	<u>X</u>
12	L	25	Y	38	<u>L</u>	51	<u>Y</u>
13	M	26	Z	39	<u>M</u>	52	<u>Z</u>

備註：“產品正印年週碼為製造日，與 Label 上之 Date Code 有差異。當同一週內生產相同產品兩批以上，正印 Date Code 將會往前編碼，故與 Label 上之顯示 Date Code 有週數差異。”



## X-ON Electronics

Largest Supplier of Electrical and Electronic Components

*Click to view similar products for [LDO Voltage Regulators](#) category:*

*Click to view products by [GSTEK\(Green Solution Technology\)](#) manufacturer:*

Other Similar products are found below :

[M38D29FFHP#U1](#) [702103A](#) [717726C](#) [742457H](#) [MP20051DN-LF-Z](#) [R5F111PGGFB#30](#) [AP7363-SP-13](#) [NCP103AMX285TCG](#)  
[NCV8664CST33T3G](#) [NCV8752AMX28TCG](#) [L9454](#) [AP7362-HA-7](#) [LX13043CLD](#) [TCR3DF185,LM\(CT](#) [TCR3DF24,LM\(CT](#)  
[TCR3DF285,LM\(CT](#) [TCR3DF31,LM\(CT](#) [TCR3DF45,LM\(CT](#) [TLF4949EJ](#) [L9708](#) [L970813TR](#) [030014BB](#) [059985X](#) [EAN61387601](#)  
[EAN61573601](#) [NCP121AMX173TCG](#) [NCP4687DH15T1G](#) [NCV8703MX30TCG](#) [701326R](#) [702087BB](#) [755078E](#) [TCR2EN28,LF\(S](#)  
[LM1117DT-1.8/NO](#) [LT1086CM#TRPBF](#) [AZ1085S2-1.5TRE1](#) [MAX15101EWL+T](#) [NCV8170AXV250T2G](#) [SCD337BTG](#)  
[TCR3DF27,LM\(CT](#) [TCR3DF19,LM\(CT](#) [TCR3DF125,LM\(CT](#) [TCR2EN18,LF\(S](#) [MAX15103EWL+T](#) [TS2937CZ-5.0 C0](#) [MAX8878EUK30-](#)  
[T](#) [MAX663CPA](#) [NCV4269CPD50R2G](#) [NCV8716MT30TBG](#) [AZ1117IH-1.2TRG1](#) [MP2013GQ-P](#)