

GT-TA037X-HXXX-LX

G-SWITCH

Operating Force
A=160gf
B=250gf

Switch Height (mm)
H029=2.9mm

Switch lifetime (Force)
L1=100,000 Cycles

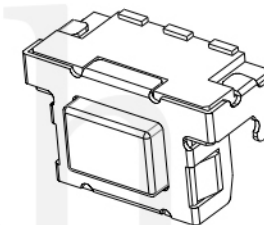

G-Switch Specification:

Operating temperature range : -30°Cto+85°C
Rating : 50mA.12V DC
Insulation resistance: : 100MΩ min.100V DC
Dielectric strength : 250V AC for 1 min
Contact resistance: : 100m Ω max.
Travel:0.20±0.1mm

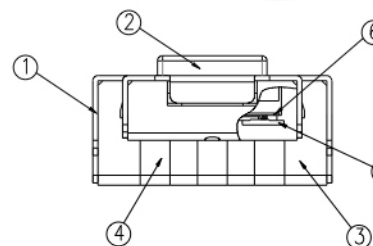
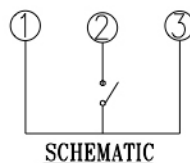
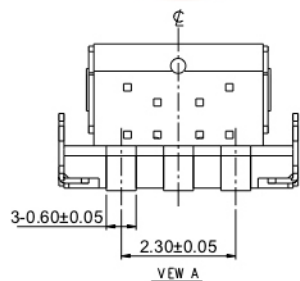
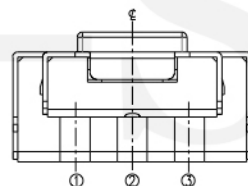
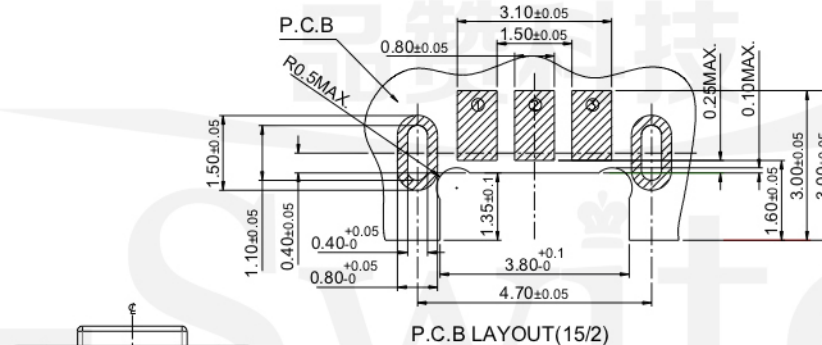
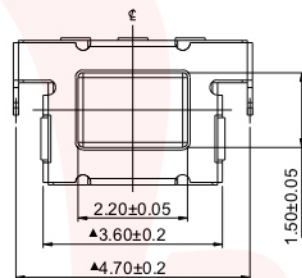

G-Switch Electronic (HongKong) CO.,Ltd.

Unless otherwise specified, Tolerance:
X. ±0.30
X.x ±0.20
X.xx ±0.15
X.xxx ±0.10
Angles ±3°

DESIGN FengFengChen DATE 2020.10.29
CHECKED DATE
APPROVED DATE
<http://www.dg-switch.com>
TEL:0769-82388879

Molde code:
GT-TA037X-HXXX-LX
REV.: X1 SCALE: 4:1 UNIT: mm
SIZE: A4 SHEET: 1/1

X-ON Electronics

Largest Supplier of Electrical and Electronic Components

Click to view similar products for [Tactile Switches](#) category:

Click to view products by [G-Switch](#) manufacturer:

Other Similar products are found below :

[5GTH92001](#) [5GTH9202242](#) [ADTSA62NV](#) [ADTSA62RV](#) [B3F-3123](#) [1977177-8](#) [1977266-1](#) [ADTSA63NV](#) [ADTSM21NSVTR](#)
[ADTSM25RVTR](#) [ADTSM32NVTR](#) [ADTSMW64RV](#) [FSMRA4JHA04](#) [GS4.70F300QP](#) [3ESH9R](#) [KSC241J](#) [SP DELTA LFS](#) [3FTL600RAS](#)
[3FTL640RAS](#) [Y96K132V0FPLFS](#) [5GSH92001](#) [5GTH9658222](#) [ADTSM31NVTR](#) [2-1977120-7](#) [TSJW-5.2-260-TR](#) [KMT011MNGJLHS](#)
[ADTSG648NV](#) [ADTSM62KSVTR](#) [ADTSM648NV](#) [95C06E3RAT](#) [3ATH9Q](#) [FSM4JSMLXTR](#) [FSM4JSMXL](#) [FSMRA8JHA04](#) [HARS0073](#)
[Y97HS12A5RAFP](#) [Y97BT23B2HAFP](#) [Y33R411N9FPLFT](#) [Y31C01402FPLFS](#) [PTS645SK50SMTR92](#) [ADTSM32NVB](#) [KMS233GPWTLFG](#)
[Y78B42324FP](#) [Y33R21116FPLFT](#) [Y31B43131FPLFG](#) [Y78B64124FP](#) [Y71243251FP](#) [Y33R31119FPLFT](#) [Y97HS12A5TAFP](#)
[PTS638SK25SMTR2LFS](#) [Y97LT25BADBFP](#)