

**GT-TC041X-HXXX-LXA**

**G-SWITCH**

**Operating Force**  
A=160gf  
B=250gf

A=Base With Pilot  
N=Non Pilot

**Switch Height (mm)**  
H010=1.0mm

**Switch lifetime (Force)**  
L1=100,000 Cycles

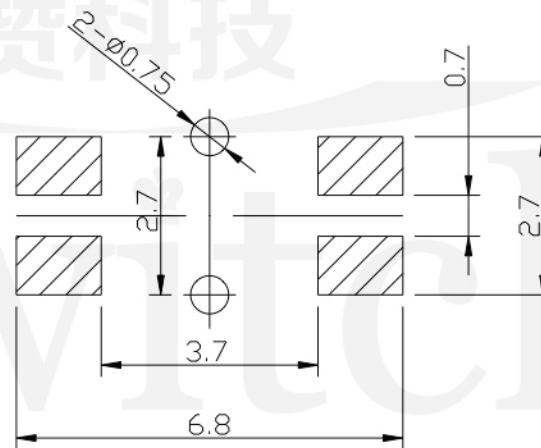
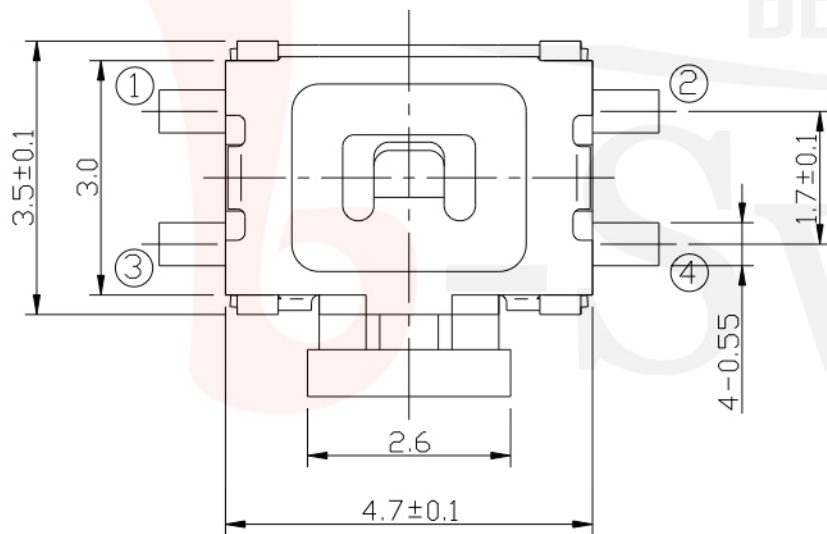

**P.C.B LAND DIMENSION**

**G-Switch Specification:**

Operating temperature range : -30°Cto+85°C  
 Rating : 50mA.12V DC  
 Insulation resistance : 100MΩ min.100V DC  
 Dielectric strength : 250V AC for 1 min  
 Contact resistance : 100m Ω max.  
 Travel:0.25±0.1mm

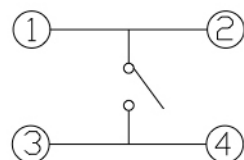

**CIRCUIT DIAGRAM**



**G-Switch Electronic (HongKong) CO.,Ltd.**

Unless otherwise specified, Tolerance:  
 X. ±0.30  
 X.x ±0.20  
 X.xx ±0.15  
 X.xxx ±0.10  
 Angles ±3°

DESIGN FengFengChen DATE 2019.05.29  
 CHECKED DATE  
 APPROVED DATE  
<http://www.dg-switch.com>  
 TEL:0769-82388879

Molde code:  
**GT-TC041X-HXXX-LXA**  
 REV.: X1 SCALE: 4:1 UNIT: mm  
 SIZE: A4 SHEET: 1/1

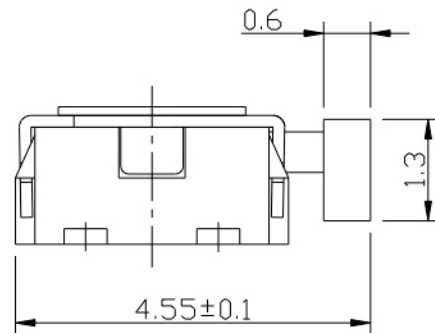
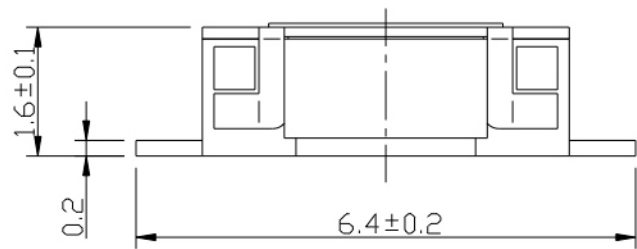

### GT-TC041X-HXXX-LXN

G-SWITCH

Operating Force  
A=160gf  
B=250gf

A=Base With Pilot  
N=Non Pilot

Switch Height (mm)  
H010=1.0mm

Switch lifetime (Force)  
L1=100,000 Cycles

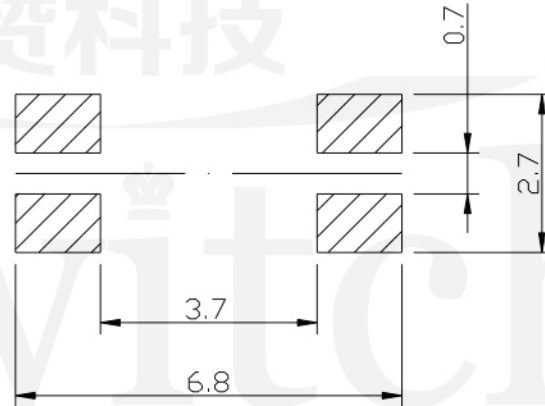
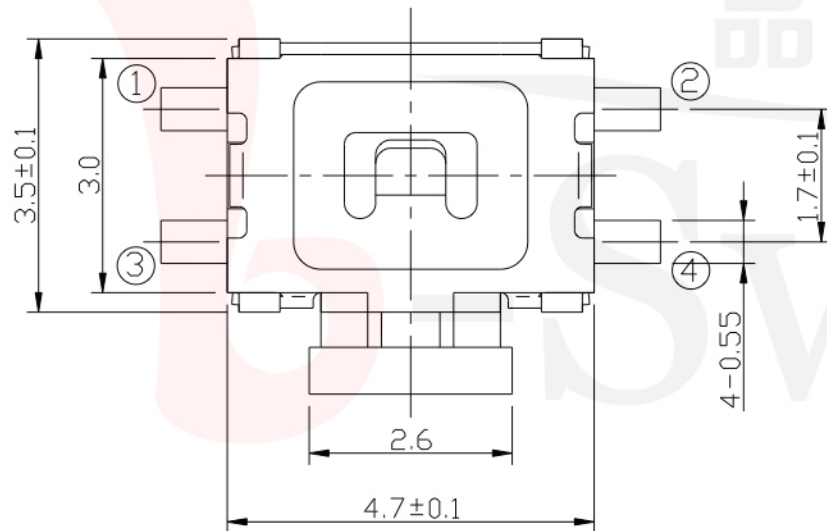

P.C.B LAND DIMENSION

**G-Switch Specification:**

Operating temperature range : -30°Cto+85°C  
 Rating : 50mA.12V DC  
 Insulation resistance : 100MΩ min.100V DC  
 Dielectric strength : 250V AC for 1 min  
 Contact resistance : 100m Ω max.  
 Travel:0.25±0.1mm

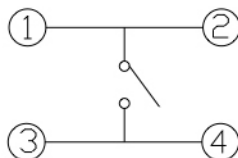

CIRCUIT DIAGRAM



	<b>G-Switch Electronic (HongKong) CO.,Ltd.</b>		
	Unless otherwise specified, Tolerance: X.           ±0.30 X.x         ±0.20 X.xx       ±0.15 X.xxx      ±0.10 Angles     ±3°	DESIGN FengFengChen CHECKED            DATE APPROVED           DATE	DATE 2019.05.29 Molde code: <b>GT-TC041X-HXXX-LXN</b>
<a href="http://www.dg-switch.com">http://www.dg-switch.com</a> TEL:0769-82388879		SIZE: A4 SHEET: 1/1	

## X-ON Electronics

Largest Supplier of Electrical and Electronic Components

*Click to view similar products for [Tactile Switches](#) category:*

*Click to view products by [G-Switch](#) manufacturer:*

Other Similar products are found below :

[5GTH92001](#) [5GTH9202242](#) [ADTSA62NV](#) [ADTSA62RV](#) [B3F-3123](#) [1977177-8](#) [1977266-1](#) [ADTSA63NV](#) [ADTSM21NSVTR](#)  
[ADTSM25RVTR](#) [ADTSM32NVTR](#) [ADTSMW64RV](#) [FSMRA4JHA04](#) [GS4.70F300QP](#) [3ESH9R](#) [KSC241J](#) [SP DELTA LFS](#) [3FTL600RAS](#)  
[3FTL640RAS](#) [Y96K132V0FPLFS](#) [5GSH92001](#) [5GTH9658222](#) [ADTSM31NVTR](#) [2-1977120-7](#) [TSJW-5.2-260-TR](#) [KMT011MNGJLHS](#)  
[ADTSG648NV](#) [ADTSM62KSVTR](#) [ADTSM648NV](#) [95C06E3RAT](#) [3ATH9Q](#) [FSM4JSMLXTR](#) [FSM4JSMXL](#) [FSMRA8JHA04](#) [HARS0073](#)  
[Y97HS12A5RAFP](#) [Y97BT23B2HAFP](#) [Y33R411N9FPLFT](#) [Y31C01402FPLFS](#) [PTS645SK50SMTR92](#) [ADTSM32NVB](#) [KMS233GPWTLFG](#)  
[Y78B42324FP](#) [Y33R21116FPLFT](#) [Y31B43131FPLFG](#) [Y78B64124FP](#) [Y71243251FP](#) [Y33R31119FPLFT](#) [Y97HS12A5TAFP](#)  
[PTS638SK25SMTR2LFS](#) [Y97LT25BADBFP](#)