

GT-TC102B-H070-L1

G-Switch	Operating Force	Switch Lifetime (Force)
	A=160gf	L05=50,000 Cycles
	B=250gf	L1=100,000 Cycles
	C=100gf	L3=300,000 Cycles
	D=360gf	L5=500,000 Cycles

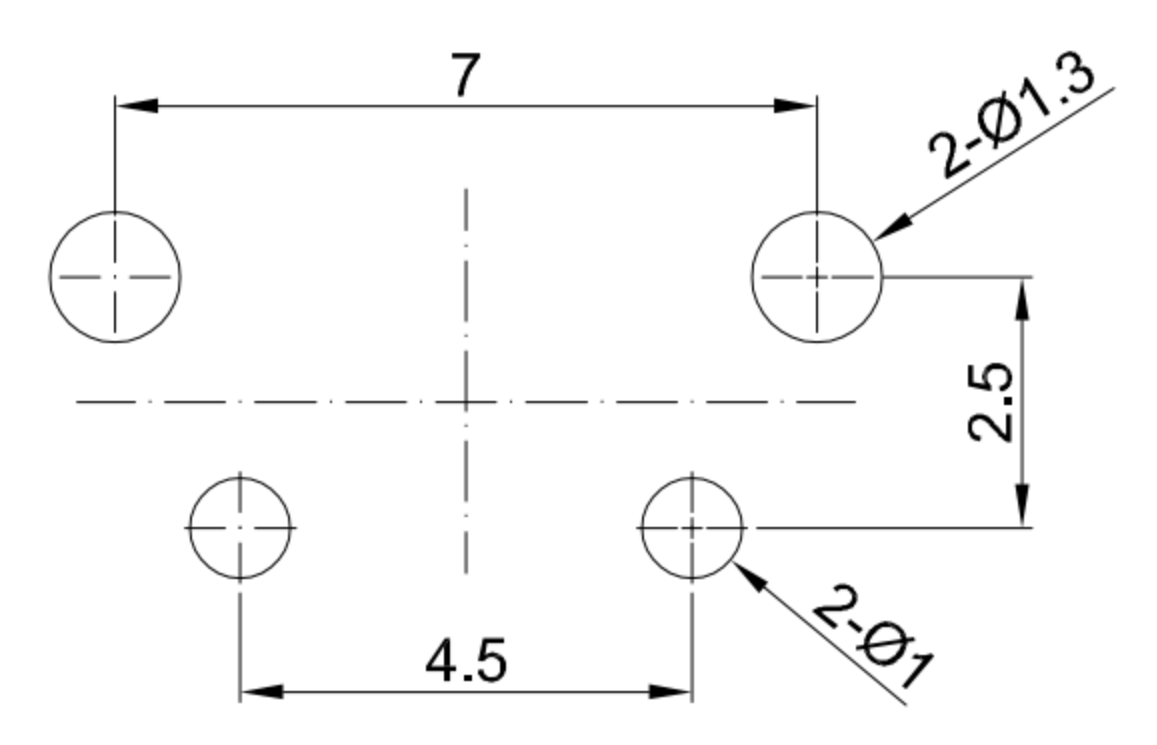
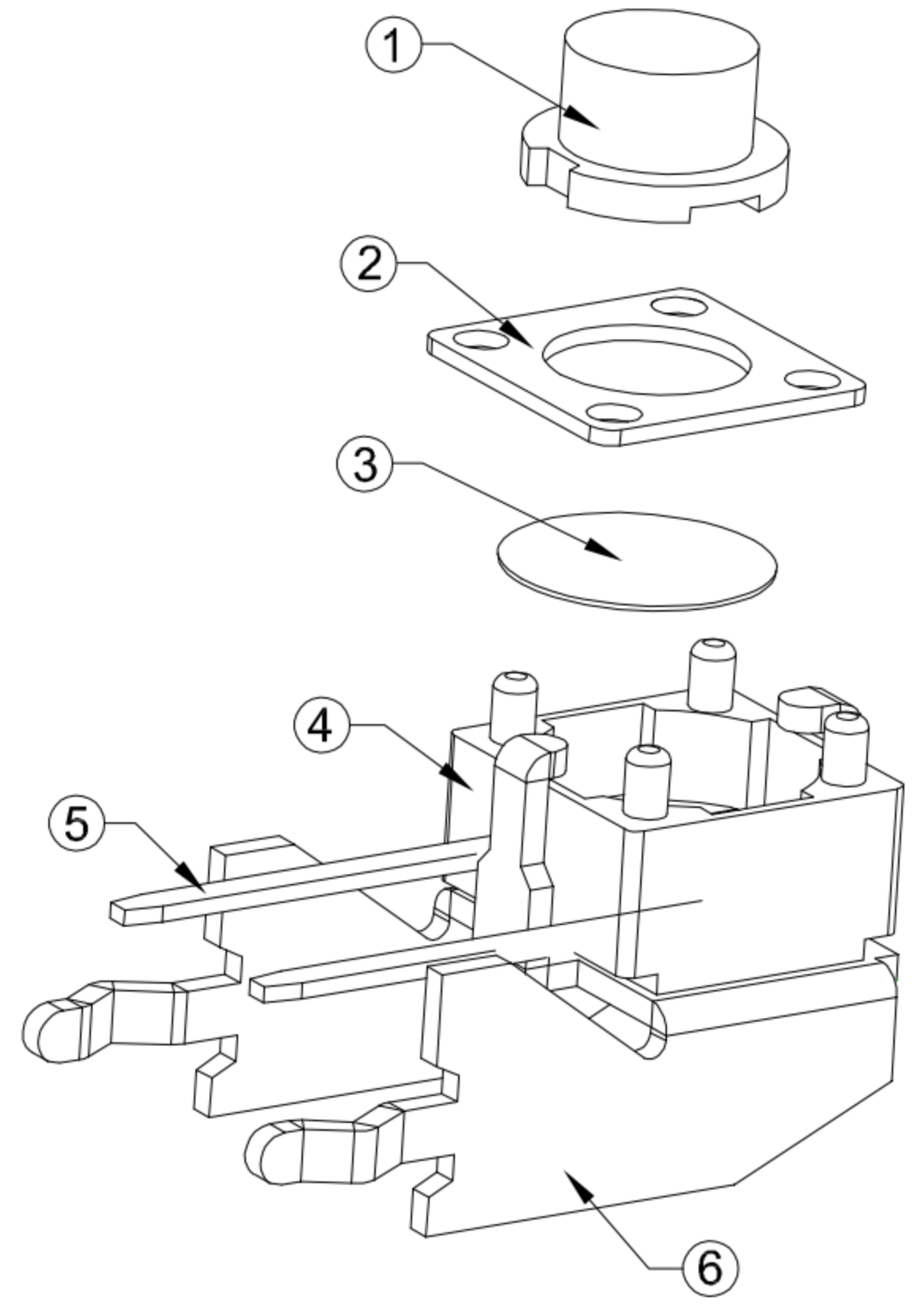
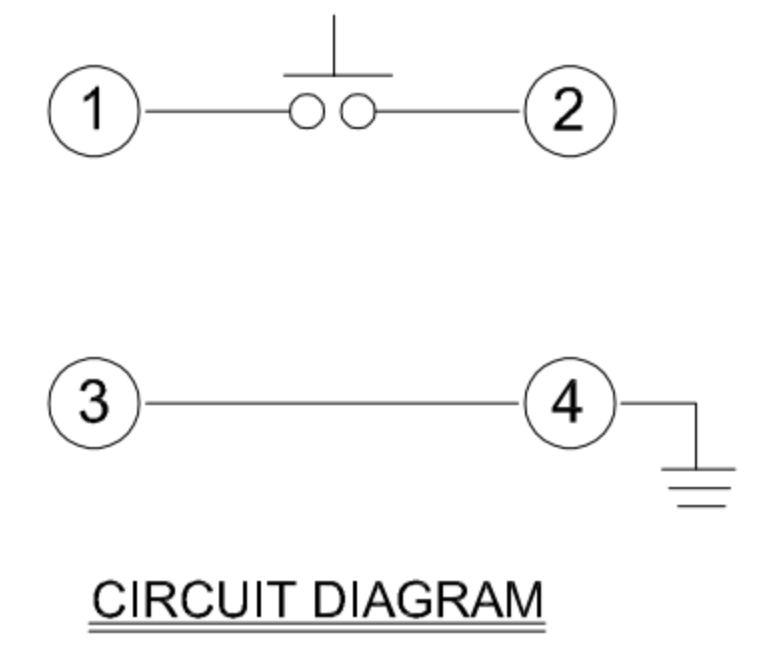

Switch Height

H043=4.3mm	H050=5.0mm
H055=5.5mm	H060=6.0mm
H065=6.5mm	H070=7.0mm
H075=7.5mm	H080=8.0mm
H085=8.5mm	H090=9.0mm
H095=9.5mm	H100=10.0mm
H105=10.5mm	H110=11.0mm
H115=11.5mm	H120=12.0mm
H125=12.5mm	H130=13.0mm
H135=13.5mm	H140=14.0mm
H145=14.5mm	H150=15.0mm
H155=15.5mm	H160=16.0mm
H165=16.5mm	H170=17.0mm
H175=17.5mm	H180=18.0mm
H185=18.5mm	H190=19.0mm

- G-Switch Specification:**
1. Operating temperature range: -40°C ~ +85°C
 2. Rating: 50mA, 12V DC
 3. Insulation resistance: 100MΩ min, 100V DC
 4. Dielectric strength: 250V AC for 1 min
 5. Contact resistance: 100mΩ max.
 6. Travel: 0.25±0.1mm

5	SUPPORT	STAINLESS STEEL	Cu/Sn
5	TERMINAL	BRASS	Ag PLATING
4	BASE	PPA	BLACK
3	CONTACT	STAINLESS STEEL	Ag PLATING
2	COVER	STAINLESS STEEL	Cu/Sn
1	STEM	PPA	BLACK
NO.	PART NAME	MATERIAL	REMARK



SCALE: 1:1	UNIT: mm	Title: Horizontal Tact Switch Support DIP CH=7.5mm 6.1×6.1×7.0mm			
SIZE: A4		Molde Code: GT-TC102B-H070-L1			
Unless otherwise General Tolerance:		DRAWN	CHECKED	APPROVED	DATE
X.	±0.20	Xia	Chen	Chen	2023.02.01
X.x	±0.15				
X.xx	±0.05				
X°	±2°				



REV: A0 SHEET: 1/1

X-ON Electronics

Largest Supplier of Electrical and Electronic Components

Click to view similar products for [Tactile Switches](#) category:

Click to view products by [G-Switch](#) manufacturer:

Other Similar products are found below :

[5GTH92001](#) [5GTH9202242](#) [6407-250V-25273P](#) [ADTSA62NV](#) [ADTSA62RV](#) [B3F-3123](#) [1977177-8](#) [1977266-1](#) [ADTSA63NV](#)
[ADTSM21NSVTR](#) [ADTSM25RVTR](#) [ADTSM32NVTR](#) [ADTSMW64RV](#) [FSMRA4JHA04](#) [GS4.70F300QP](#) [KSC241J SP DELTA LFS](#)
[3FTL600RAS](#) [3FTL640RAS](#) [Y96K132V0FPLFS](#) [5GTH9658222](#) [ADTSM31NVTR](#) [2-1977120-7](#) [TSJW-5.2-260-TR](#) [KMT011MNGJLHS](#)
[B3WN6002S](#) [70-201.0](#) [ADTSG648NV](#) [ADTSM62KSVTR](#) [ADTSM648NV](#) [95C06E3RAT](#) [5GTH96561](#) [3ATH9Q](#) [FSMRA8JHA04](#)
[HARS0073](#) [Y33R411N9FPLFT](#) [Y31C01402FPLFS](#) [PTS645SK50SMTR92](#) [ADTSM32NVB](#) [KMS233GPWTLFG](#) [Y78B64124FP](#)
[Y96D113G0FP LFS](#) [Y33A812C5FP LFT](#) [Y56B2D120FP LFS](#) [PTS645 DVM83-BN125-2 LFS](#) [B3W 1000G](#) [KSC621G OL LFS](#) [B3F 1002C](#)
[B3F 0047H](#) [B3F 1000G](#) [B3W 1002C](#)