

GT-TC171X-H014-LX

**G-SWITCH Operating Force**

A=160gf  
B=250gf  
E=400gf

**Switch Height (mm)**

H014=1.4mm

**Switch lifetime (Force)**

L05=50,000 Cycles (E)  
L1=100,000 Cycles  
L2=200,000 Cycles

**G-Switch Specification:**

Operating temperature range: -30°C to +85°C  
Rating: 50mA, 12V DC  
Insulation resistance: 100MΩ min. 100V DC  
Dielectric strength: 250V AC for 1 min  
Contact resistance: 100mΩ max.  
Travel: 0.12±0.05mm

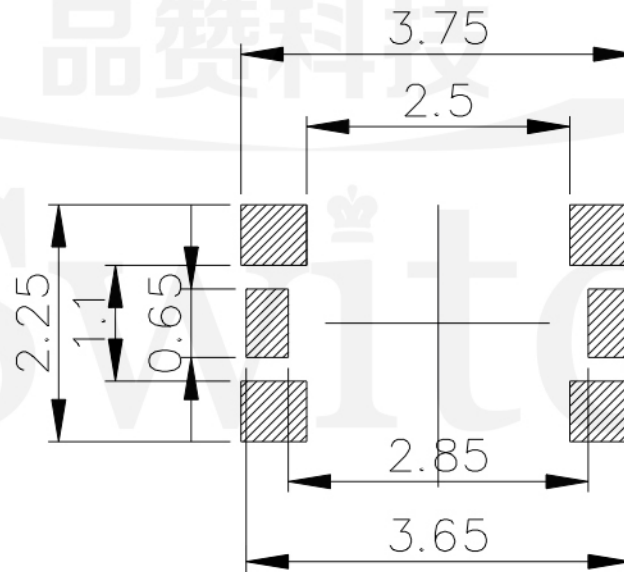
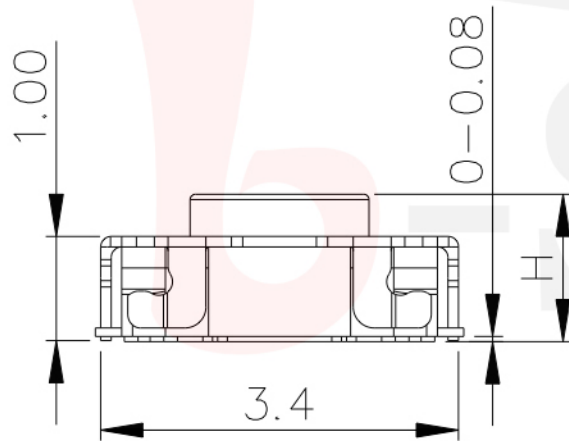

P.C.B LAND DIMENSION

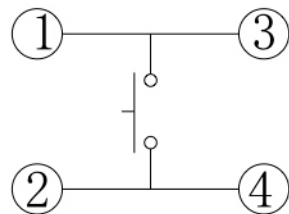

**CIRCUIT DIAGRAM**



**G-Switch Electronic (HongKong) CO.,Ltd.**

Unless otherwise specified, Tolerance:  
X. ±0.30  
X.x ±0.20  
X.xx ±0.15  
X.xxx ±0.10  
Angles ±3°

DESIGN	陈锋枫	DATE	2019.05.29
CHECKED		DATE	
APPROVED		DATE	
<a href="http://www.dg-switch.com">http://www.dg-switch.com</a>			
TEL: 0769-82388879			

Molde code:		
GT-TC171X-H014-LX		
REV.: X1	SCALE: 4:1	UNIT: mm
SIZE: A4	SHEET: 1/1	

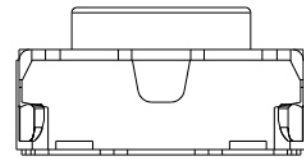
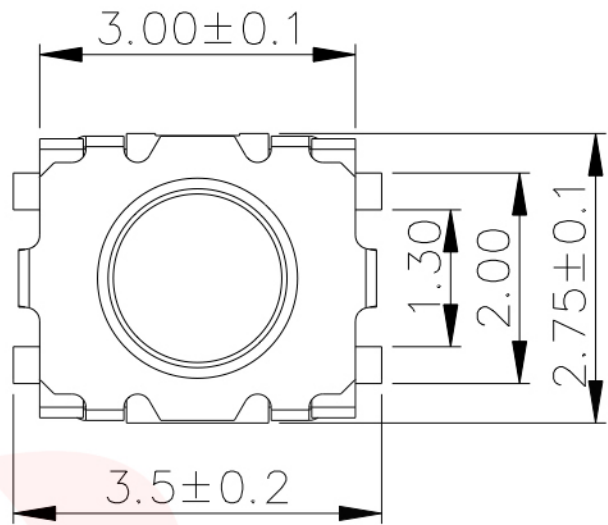

GT-TS171X-H014-LX

**G-SWITCH Operating Force**  
 A=160gf  
 B=250gf  
 E=400gf

**Switch Height (mm)**  
 H014=1.4mm

**Switch lifetime (Force)**  
 L05=50,000 Cycles (E)  
 L1=100,000 Cycles  
 L2=200,000 Cycles

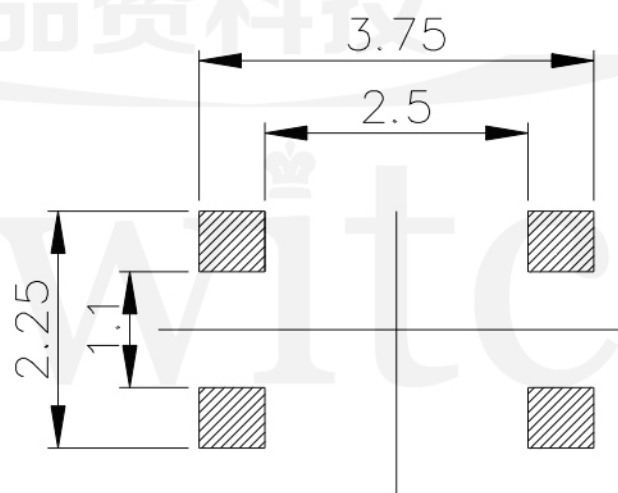
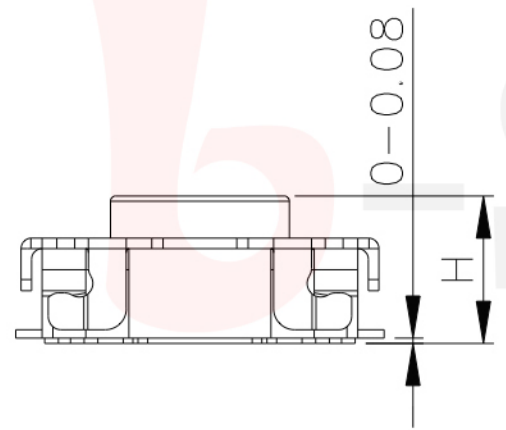

P.C.B LAND DIMENSION

G-Switch Specification:  
 Operating temperature range: -30°C to +85°C  
 Rating: 50mA, 12V DC  
 Insulation resistance: 100MΩ min. 100V DC  
 Dielectric strength: 250V AC for 1 min  
 Contact resistance: 100mΩ max.  
 Travel: 0.12 ± 0.05mm

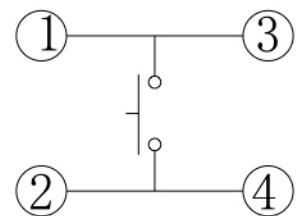

**CIRCUIT DIAGRAM**



	<b>G-Switch Electronic (HongKong) CO.,Ltd.</b>		
	DESIGN 陈锋枫	DATE 2019.05.29	Molde code: GT-TS171X-H014-LX
	CHECKED	DATE	
	APPROVED	DATE	REV.: X1
Unless otherwise specified, Tolerance: X. ±0.30 X.x ±0.20 X.xx ±0.15 X.xxx ±0.10 Angles ±3°	<a href="http://www.dg-switch.com">http://www.dg-switch.com</a> TEL: 0769-82388879		SCALE: 4:1 SHEET: 1/1

## X-ON Electronics

Largest Supplier of Electrical and Electronic Components

*Click to view similar products for [Tactile Switches](#) category:*

*Click to view products by [G-Switch](#) manufacturer:*

Other Similar products are found below :

[5GTH92001](#) [5GTH9202242](#) [6407-250V-25273P](#) [ADTSA62NV](#) [ADTSA62RV](#) [B3F-3123](#) [1977177-8](#) [1977266-1](#) [ADTSA63NV](#)  
[ADTSM21NSVTR](#) [ADTSM25RVTR](#) [ADTSM32NVTR](#) [ADTSMW64RV](#) [FSMRA4JHA04](#) [GS4.70F300QP](#) [3ESH9R](#) [KSC241J](#) [SP DELTA](#)  
[LFS](#) [3FTL600RAS](#) [3FTL640RAS](#) [Y96K132V0FPLFS](#) [5GTH9658222](#) [ADTSM31NVTR](#) [EVQ-P1D05K](#) [2-1977120-7](#) [TSJW-5.2-260-TR](#)  
[KMT011MNGJLHS](#) [70-201.0](#) [ADTSG648NV](#) [ADTSM62KSVTR](#) [ADTSM648NV](#) [95C06E3RAT](#) [5GTH96561](#) [3ATH9Q](#) [FSM4JSMLXTR](#)  
[FSM4JSMXL](#) [FSMRA8JHA04](#) [HARS0073](#) [Y97HS12A5RAFP](#) [Y97BT23B2HAFP](#) [Y33R411N9FPLFT](#) [Y31C01402FPLFS](#)  
[PTS645SK50SMTR92](#) [ADTSM32NVB](#) [KMS233GPWTLFG](#) [Y78B42324FP](#) [Y33R21116FPLFT](#) [Y31B43131FPLFG](#) [Y78B64124FP](#)  
[Y71243251FP](#) [Y33R31119FPLFT](#)