

GT-TC171X-H014-LX

G-SWITCH Operating Force

A=160gf
B=250gf
E=400gf

Switch Height (mm)

H014=1.4mm

Switch lifetime (Force)

L05=50,000 Cycles (E)
L1=100,000 Cycles
L2=200,000 Cycles

G-Switch Specification:

Operating temperature range: -30°C to +85°C
Rating: 50mA, 12V DC
Insulation resistance: 100MΩ min. 100V DC
Dielectric strength: 250V AC for 1 min
Contact resistance: 100mΩ max.
Travel: 0.12±0.05mm

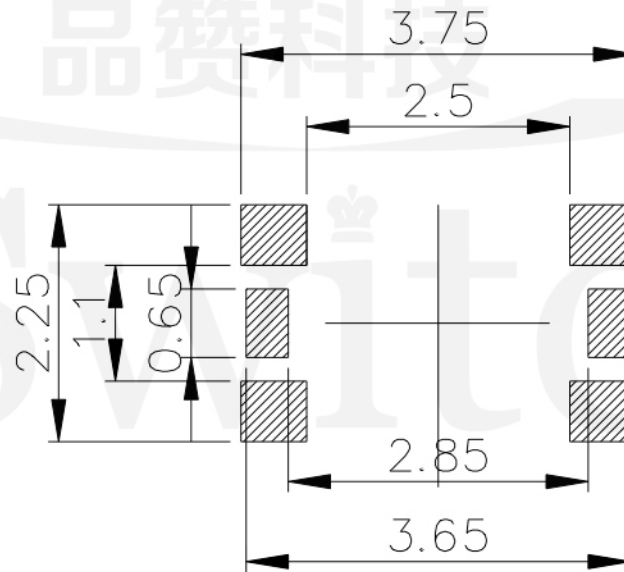
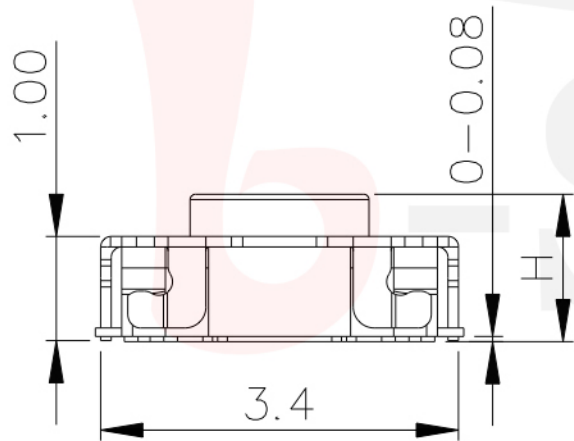

P.C.B LAND DIMENSION

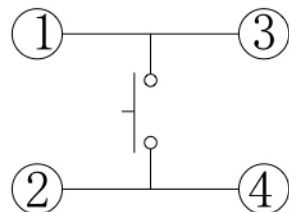

CIRCUIT DIAGRAM



G-Switch Electronic (HongKong) CO.,Ltd.

Unless otherwise specified, Tolerance:
X. ±0.30
X.x ±0.20
X.xx ±0.15
X.xxx ±0.10
Angles ±3°

DESIGN	陈锋枫	DATE	2019.05.29
CHECKED		DATE	
APPROVED		DATE	
http://www.dg-switch.com			
TEL: 0769-82388879			

Molde code:		
GT-TC171X-H014-LX		
REV.: X1	SCALE: 4:1	UNIT: mm
SIZE: A4	SHEET: 1/1	

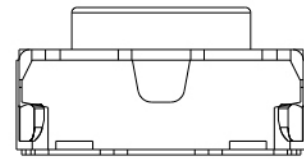
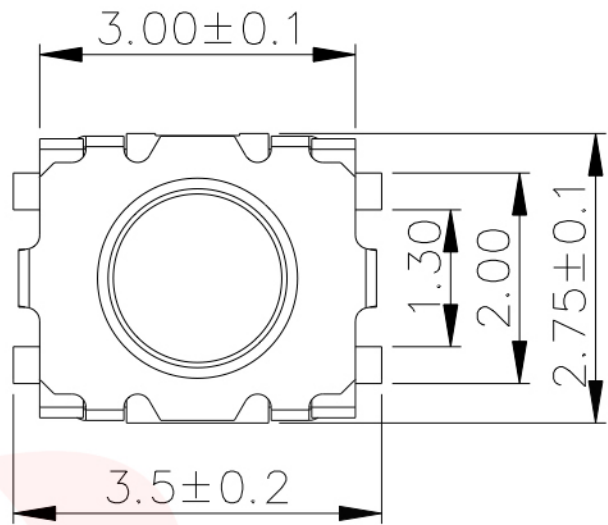

GT-TS171X-H014-LX

G-SWITCH Operating Force
 A=160gf
 B=250gf
 E=400gf

Switch Height (mm)
 H014=1.4mm

Switch lifetime (Force)
 L05=50,000 Cycles (E)
 L1=100,000 Cycles
 L2=200,000 Cycles

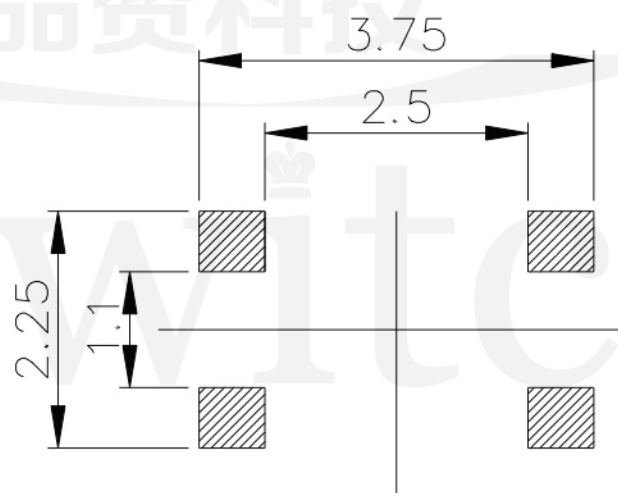
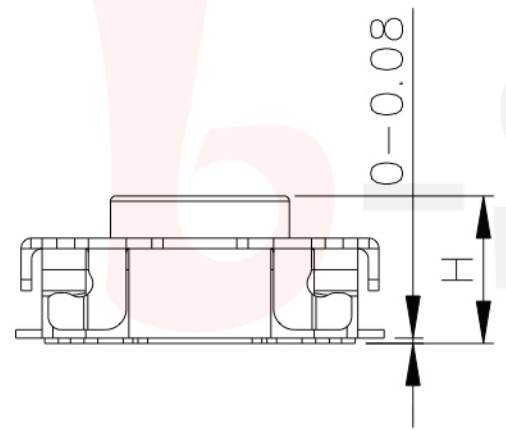

P.C.B LAND DIMENSION

G-Switch Specification:
 Operating temperature range: -30°C to +85°C
 Rating: 50mA, 12V DC
 Insulation resistance: 100MΩ min. 100V DC
 Dielectric strength: 250V AC for 1 min
 Contact resistance: 100mΩ max.
 Travel: 0.12 ± 0.05mm

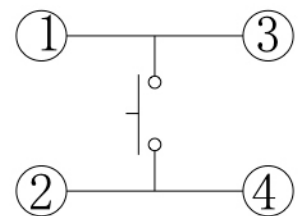

CIRCUIT DIAGRAM



	G-Switch Electronic (HongKong) CO.,Ltd.		
	DESIGN 陈锋枫	DATE 2019.05.29	Molde code: GT-TS171X-H014-LX
	CHECKED	DATE	
	APPROVED	DATE	REV.: X1
Unless otherwise specified, Tolerance: X. ±0.30 X.x ±0.20 X.xx ±0.15 X.xxx ±0.10 Angles ±3°	http://www.dg-switch.com TEL: 0769-82388879		SCALE: 4:1 SHEET: 1/1

X-ON Electronics

Largest Supplier of Electrical and Electronic Components

Click to view similar products for [Tactile Switches](#) category:

Click to view products by [G-Switch](#) manufacturer:

Other Similar products are found below :

[5GTH92001](#) [5GTH9202242](#) [ADTSA62NV](#) [ADTSA62RV](#) [B3F-3123](#) [1977177-8](#) [1977266-1](#) [ADTSA63NV](#) [ADTSM21NSVTR](#)
[ADTSM25RVTR](#) [ADTSM32NVTR](#) [ADTSMW64RV](#) [FSMRA4JHA04](#) [GS4.70F300QP](#) [3ESH9R](#) [KSC241J SP DELTA LFS](#) [3FTL600RAS](#)
[3FTL640RAS](#) [Y96K132V0FPLFS](#) [5GSH92001](#) [5GTH9658222](#) [ADTSM31NVTR](#) [2-1977120-7](#) [TSJW-5.2-260-TR](#) [KMT011MNGJLHS](#)
[ADTSG648NV](#) [ADTSM62KSVTR](#) [ADTSM648NV](#) [95C06E3RAT](#) [3ATH9Q](#) [FSM4JSMLXTR](#) [FSM4JSMXL](#) [FSMRA8JHA04](#) [HARS0073](#)
[Y97HS12A5RAFP](#) [Y97BT23B2HAFP](#) [Y33R411N9FPLFT](#) [Y31C01402FPLFS](#) [PTS645SK50SMTR92](#) [ADTSM32NVB](#) [KMS233GPWTLFG](#)
[Y78B42324FP](#) [Y33R21116FPLFT](#) [Y31B43131FPLFG](#) [Y78B64124FP](#) [Y71243251FP](#) [Y33R31119FPLFT](#) [Y97HS12A5TAFP](#)
[PTS638SK25SMTR2LFS](#) [Y97LT25BADBFP](#)