

RECOMMENDED P.C.B. LAYOUT
TOLERANCE UNSPECIFIED ±0.05mm

A1	GND	B12	GND
A4	VBUS	B9	VBUS
A5	CC1	B8	SBU2
A6	DP1	B7	DN2
A7	DN1	B6	DP2
A8	SBU1	B5	CC2
A9	VBUS	B4	VBUS
A12	GND	B1	GND
PIN	SIGNAL NAME	PIN	SIGNAL NAME

NOTES:
SPECIFICATION:

1. CURRENT RATING: 5A MAX
2. VOLTAGE: 100 VAC
3. TEMPERATURE RANGE: -30 °C ~ 85 °C
4. CONTACT RESISTANCE: 40 MILLIONHM MAX
5. INSULATION RESISTANCE: 100 MEGOHMS MIN.
6. INSERTION FORCE : 5N~20N
7. UNMATING FORCE: 8N~20N
8. DURABILITY: 10,000 CYCLES

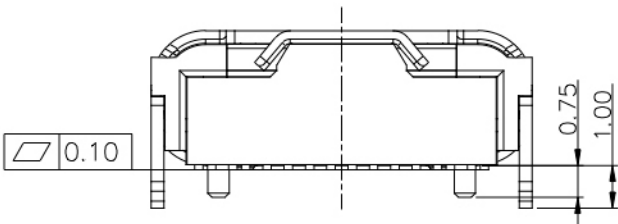

G-Switch Electronic Technology CO.,Ltd.

Unless otherwise specified, Tolerance:
X. ±0.30
X.x ±0.20
X.xx ±0.15
X.xxx ±0.10
Angles ±3°

DESIGN 陈锋枫 DATE 2016.05.29
APPROVED DATE
<http://www.dg-switch.com>
TEL:0769-82388879

TITLE:
GT-USB-7010A
REV.: X1 SCALE: 4:1 UNIT: mm
SIZE: A4 SHEET: 1/1

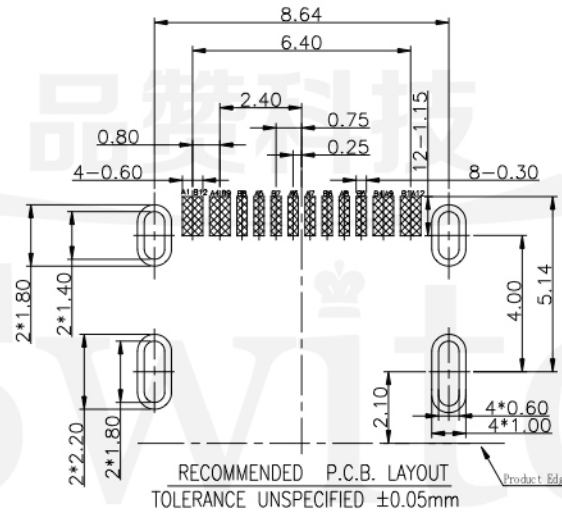
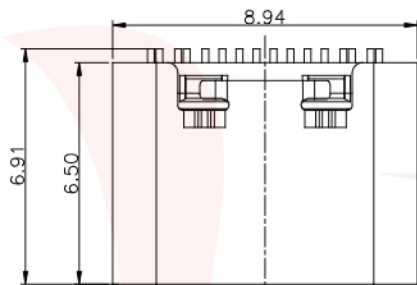
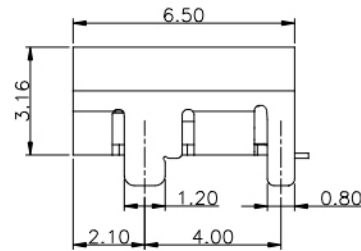
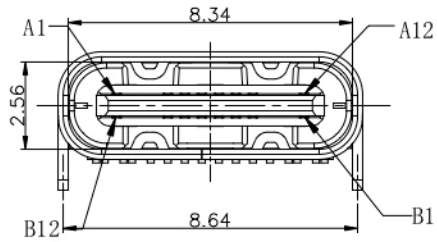

A1	GND	B12	GND
A4	VBUS	B9	VBUS
A5	CC1	B8	SBU2
A6	DP1	B7	DN2
A7	DN1	B6	DP2
A8	SBU1	B5	CC2
A9	VBUS	B4	VBUS
A12	GND	B1	GND
PIN	SIGNAL NAME	PIN	SIGNAL NAME

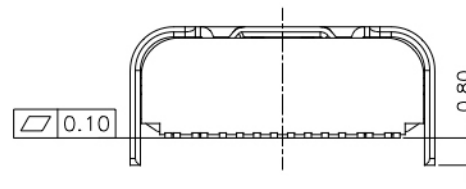
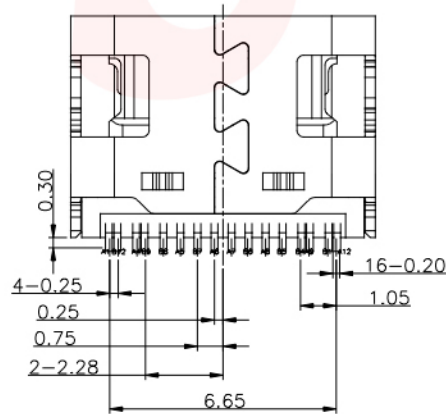

NOTES:

SPECIFICATION:

1. CURRENT RATING: 5.0A MAX
2. VOLTAGE: 100 VAC
3. TEMPERATURE RANGE: -30 °C ~ 85 °C
4. CONTACT RESISTANCE: 40 MILLIONHM MAX
5. INSULATION RESISTANCE: 100 MEGOHMS MIN.
6. INSERTION FORCE : 5N~20N
7. UNMATING FORCE: 8N~20N
8. DURABILITY: 10,000 CYCLES



G-Switch Electronic (HongKong) CO.,Ltd.

Unless otherwise specified, Tolerance:
 X. ±0.30
 X.x ±0.20
 X.xx ±0.15
 X.xxx ±0.10
 Angles ±3°

DESIGN FengFengChen

DATE 2019.05.29

Molde code:

CHECKED

DATE

GT-USB-7010B

APPROVED

DATE

<http://www.dg-switch.com>

REV.: X1 SCALE: 4:1 UNIT: mm

TEL:0769-82388879

SIZE: A4 SHEET: 1/1

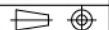

X-ON Electronics

Largest Supplier of Electrical and Electronic Components

Click to view similar products for [USB Connectors](#) category:

Click to view products by [G-Switch](#) manufacturer:

Other Similar products are found below :

[950](#) [A-USB A-LP-SMT-C](#) [A-USB B-TOP-C](#) [MUSBA511N5](#) [MUSBC111M5](#) [MUSBD11135](#) [17-200721](#) [217450-1](#) [KMBVX-TH-5S-B30](#)
[896-30-004-00-000000](#) [KUSBX-AS2N-W](#) [KUSBX-SMT2AP1S-W30](#) [935](#) [957](#) [30-498-6](#) [SK-60A-2](#) [1734082-1](#) [CIR08F-20](#) [30-1574](#) [30-470](#)
[30-489](#) [30-541](#) [MAB 5 S](#) [A-USB A-2P-C](#) [MIKROE-1451](#) [USBFTV2PEM2G](#) [USBFTVSCCG](#) [4689-1](#) [1-1734084-2](#) [MUSBA81130](#)
[MUSBC11135](#) [CIR08F-20-27P-F80-VO](#) [USBF21ZNSCC](#) [USBBFTV6ZC](#) [MUSBB151341](#) [10135326-001LF](#) [M9177/3-1](#) [USB-A-S-F-B-VT](#)
[4198](#) [1310-1018-05](#) [690-024-633-031](#) [UB-20PMFP-LC7001](#) [USBFTVC6MRG](#) [UA-20BMFA-SL8001](#) [17-200011](#) [USBFTVC7ZC](#) [UB-](#)
[20AFMM-LL7A01](#) [USBFTVC2MN](#) [CAP-WCCMLPB1](#) [CAP-WCCMLPC1](#)