

AFTER MATING

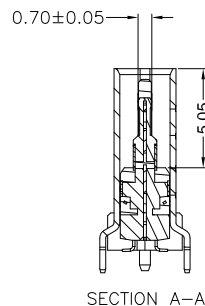
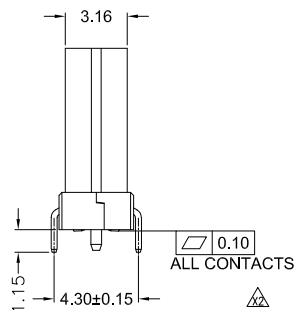
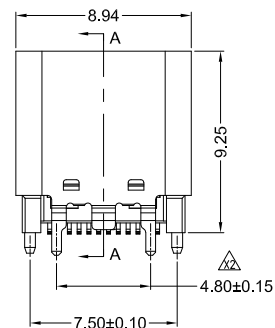

SECTION A-A

NOTE:

1. MECHANICAL PERFORMANCE.

- 1-1. INSERTION FORCE: 5~20N.
- 1-2. REMOVAL FORCE: 8~20N, 6~20N AFTER TEST;
- 1-3. DURABILITY: 10000 CYCLES.

2. ELECTRICAL PERFORMANCE.

- 2-1. CURRENT RATING: 5.0A
VOLTAGE RATING: 5.0V
- 2-2. LLCR:
VBUS & GND PINS AND OTHER PINS: 40mΩ/PIN MAX.
SHIELD: 50mΩ/MAX.
LLCR MAX. CHANGE OF ALL PINS: 10mΩ.
- 2-3. INSULATION RESISTANCE: 100MΩ MIN
- 2-4. DIELECTRIC WITHSTAND VOLTAGE, AC 100V FOR 1 MINUTE.

3. ENVIRONMENTAL PERFORMANCE:

- OPERATING TEMPERATURE: -45°C~+85°C.
- 4. IR REFLOW:
THE PEAK TEMPERATURE ON THE BOARD SHALL
BE MAINTAINED FOR 10 SECONDS AT 260°C.

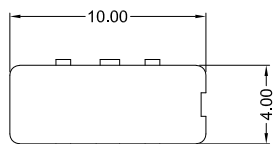

WITH PICK UP COVER

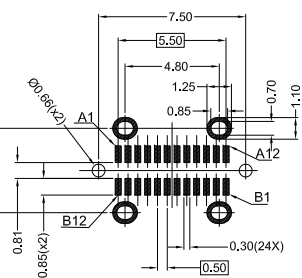
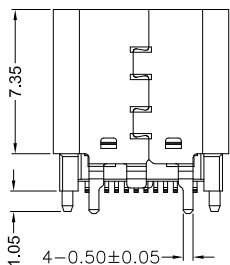
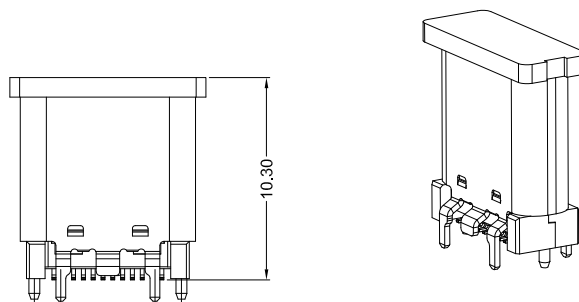

RECOMMENDED PCB LAYOUT(TOP VIEW)
THICKNESS 1.5±0.10MM; DEFAULT TOLERANCE: ±0.05



G-Switch Electronic (HongKong) CO.,Ltd.

Unless otherwise specified, Tolerance:
X. ±0.30
X.x ±0.20
X.xx ±0.15
X.xxx ±0.10
Angles ±3°

DESIGN Li Qingqi DATE 2022.04.21
CHECKED DATE
APPROVED DATE
<http://www.dg-switch.com>
TEL: 0769-82388879

Molde code:
GT-USB-7019B
REV.: X1 SCALE: 4:1 UNIT: mm
SIZE: A4 SHEET: 1/1

A1	A2	A3	A4	A5	A6	A7	A8	A9	A10	A11	A12
GND	TX1+	TX1-	VBUS	CC1	D+	D-	SBU1	VBUS	RX2-	RX2+	GND
GND	RX1+	RX1-	VBUS	SBU2	D-	D+	CC2	VBUS	TX2-	TX2+	GND
B12	B11	B10	B9	B8	B7	B6	B5	B4	B3	B2	B1

Item	Title	Material	Dispose	Remark
1	Shell	Stainless Steel	Ni:30u" Min.	—
2	GND Plate	Stainless Steel	Clear Only	—
3	Mid Plate	Stainless Steel	Clear Only	—
4	Top Contact	Copper Alloy	Mating Area: See P/N	—
5	Bottom Contact	Copper Alloy	Solder Tails: Matt Tin	—
6	Insulator	High Temperature Plastic	UL 94V-0	Black
7	HOUSING	HIGH TEMPERATURE RESISTANT PLASTIC(LCP),UL94 V-0.		
8	CONTACTS	COPPER ALLOY(C18150)T=0.12mm		
9	MID PLATE	STAINLESS STEEL(SUS301)T=0.15mm		
10	EMI PLATE	STAINLESS STEEL(SUS301)T=0.10mm		
11	SHELL	STAINLESS STEEL(SUS304)T=0.30mm		

X-ON Electronics

Largest Supplier of Electrical and Electronic Components

Click to view similar products for [USB Connectors](#) category:

Click to view products by [G-Switch](#) manufacturer:

Other Similar products are found below :

[950](#) [A-USB B-TOP-C](#) [MUSBA511N5](#) [MUSBC111M5](#) [MUSBD11135](#) [17-200721](#) [217450-1](#) [KMBVX-TH-5S-B30](#) [896-30-004-00-000000](#)
[KUSBX-AS2N-W](#) [KUSBX-SMT2AP1S-W30](#) [935](#) [957](#) [30-498-6](#) [SK-60A-2](#) [1734082-1](#) [30-1574](#) [30-470](#) [30-489](#) [30-541](#) [30-572-3](#) [A-USB](#)
[A-2P-C](#) [MIKROE-1451](#) [USBFTV2PEM2G](#) [USBFTVSCCG](#) [4689-1](#) [1-1734084-2](#) [MUSBC11135](#) [USBF21ZNSCC](#) [USBBFTV6ZC](#)
[MUSBB151341](#) [10135326-001LF](#) [M9177/3-1](#) [TJ-105](#) [USB-A-S-F-B-VT](#) [4198](#) [690-024-633-031](#) [UB-20PMFP-LC7001](#) [USBFTVC6MRG](#)
[UA-20BMFA-SL8001](#) [17-200011](#) [USBFTVC7ZC](#) [UB-20AFMM-LL7A01](#) [USBFTVC2MN](#) [CAP-WCCMLPB1](#) [1310-1031-01](#) [2041386-1](#)
[2274475-3](#) [UB-20BMFA-SL8001](#) [UB-20PMFP-SC8003](#)