

SECTION A-A
SCALE 1:1

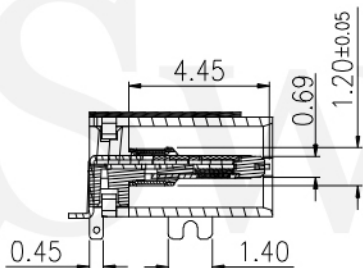

SECTION B-B
SCALE 1:1

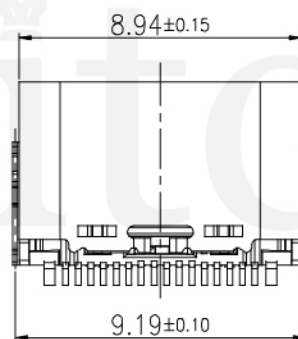

NOTES:

1. ELECTRICAL:
 - 1.1. CONTACT CURRENT RATING 5.0A FOR VBUS AND GND (PINS A4 A9 B4 B9)
 - 1.2. INSULATION RESISTANCE: 100 MEGAOHMS MIN. AT 250VDC.
 - 1.3. DIELECTRIC WITHSTANDING VOLTAGE: 100VAC MIN.
 - 1.4. LOW CONTACT RESISTANCE: INITIAL 40mΩ MAX. AFTER 50mΩ MAX.
2. MECHANICAL CHARACTERISTICS:
 - 2.1. INSERTION FORCE: 5N~20N.
 - 2.2. EXTRACTION FORCE: 8N~20N FORM 1 TO 1000CYCLES. 6~20N FORM 1001 TO 10000CYCLES.
 - 2.3. DURABILITY: 10,000 MATING CYCLES
 - 2.4. OPERATING TEMPERATURE: -55°C TO +85°C
3. COPLANARITY: 0.10MAX.

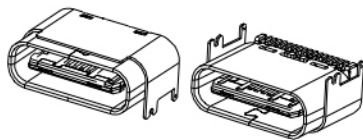
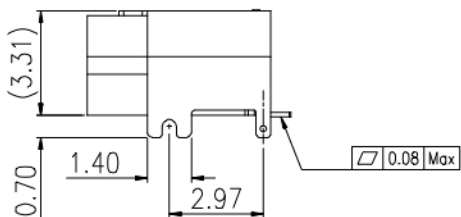

G-Switch Electronic Technology CO.,Ltd.

Unless otherwise specified, Tolerance:
 X. ±0.30
 X.x ±0.20
 X.xx ±0.15
 X.xxx ±0.10
 Angles ±3°

DESIGN	陈锋枫	DATE	2016.05.29
CHECKED		DATE	
APPROVED		DATE	
http://www.dg-switch.com			
TEL: 0769-82388879			

TITLE: GT-USB-7025		
REV.: X1	SCALE: 4:1	UNIT: mm
SIZE: A4	SHEET: 1/1	

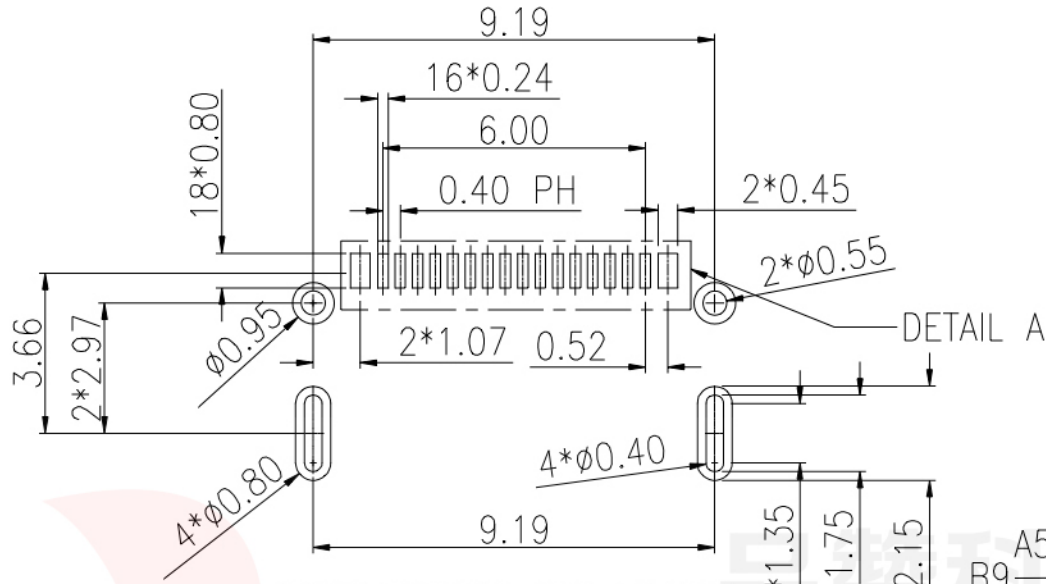

RECOMMENDED PCB LAYOUT

GENERAL TOLERANCE ± 0.05

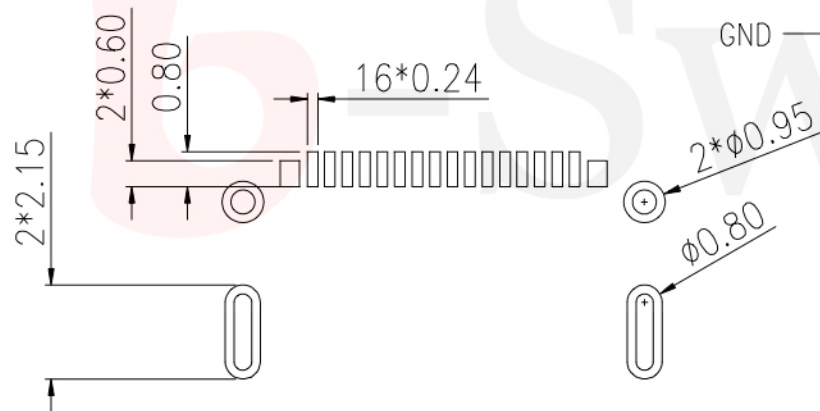

RECOMMENDED STENCIL LAYOUT

GENERAL TOLERANCE ± 0.05

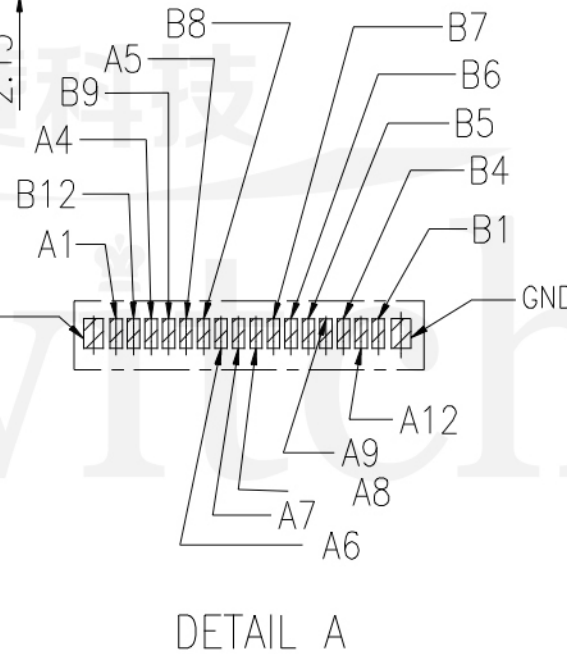

PIN	SIGNAL NAME	PIN	SIGNAL NAME
A1	GND	B12	GND
A2		B11	
A3		B10	
A4	VBUS	B9	VBUS
A5	CC1	B8	SBU2
A6	Dp1	B7	Dn2
A7	Dn1	B6	Dp2
A8	SBU1	B5	CC2
A9	VBUS	B4	VBUS
A10		B3	
A11		B2	
A12	GND	B1	GND



G-Switch Electronic Technology CO.,Ltd.

Unless otherwise specified, Tolerance:
 X. ± 0.30
 X.x ± 0.20
 X.xx ± 0.15
 X.xxx ± 0.10
 Angles $\pm 3^\circ$

DESIGN 陈锋枫 DATE 2016.05.29
 CHECKED DATE
 APPROVED DATE
<http://www.dg-switch.com>
 TEL: 0769-82388879

TITLE:
 GT-USB-7025
 REV.: X1 SCALE: 4:1 UNIT: mm
 SIZE: A4 SHEET: 1/1

X-ON Electronics

Largest Supplier of Electrical and Electronic Components

Click to view similar products for [USB Connectors](#) category:

Click to view products by [G-Switch](#) manufacturer:

Other Similar products are found below :

[950](#) [A-USB A-LP-SMT-C](#) [A-USB B-TOP-C](#) [MUSBA511N5](#) [MUSBC111M5](#) [MUSBD11135](#) [17-200721](#) [217450-1](#) [KMBVX-TH-5S-B30](#)
[896-30-004-00-000000](#) [KUSBX-AS2N-W](#) [KUSBX-SMT2AP1S-W30](#) [935](#) [957](#) [30-498-6](#) [SK-60A-2](#) [1734082-1](#) [30-1574](#) [30-470](#) [30-489](#) [30-](#)
[541](#) [30-572-3](#) [A-USB A-2P-C](#) [MIKROE-1451](#) [USBFTV2PEM2G](#) [USBFTVSCCG](#) [4689-1](#) [1-1734084-2](#) [MUSBC11135](#) [USBF21ZNSCC](#)
[USBBFTV6ZC](#) [MUSBB151341](#) [10135326-001LF](#) [M9177/3-1](#) [TJ-105](#) [USB-A-S-F-B-VT](#) [4198](#) [690-024-633-031](#) [UB-20PMFP-LC7001](#)
[USBFTVC6MRG](#) [UA-20BMFA-SL8001](#) [17-200011](#) [USBFTVC7ZC](#) [UB-20AFMM-LL7A01](#) [USBFTVC2MN](#) [CAP-WCCMLPB1](#) [1310-](#)
[1031-01](#) [2041386-1](#) [2274475-3](#) [UB-20BMFA-SL8001](#)