

SUGGESTED RUBBER RING SIZE

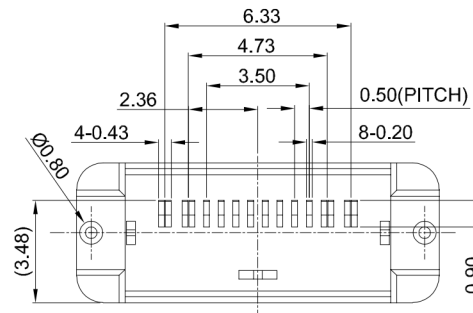

**G-Switch USB-C Specification:**

1. Current rated: 3A on vbus/1.25A on vconn/0.25A on other
2. Voltage rating: 24V AC
3. Withstanding voltage: 100V AC/minute
4. Contact resistance: 40mΩ Max
5. Insulation resistance: 100MΩ Min
6. Operating temperature: -40°C ~ +85°C
7. Mating force: 5N~20N
8. Unmating force: 8N~20N
9. Durability cycle: 10,000 cycles
9. Waterproof grade: IP-X7.

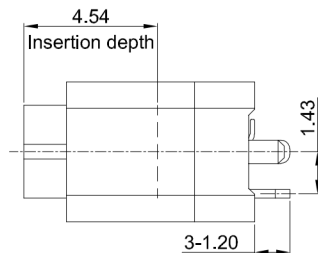
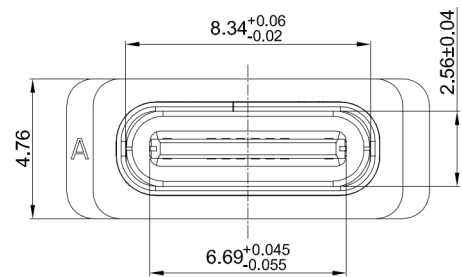
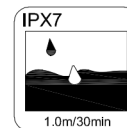
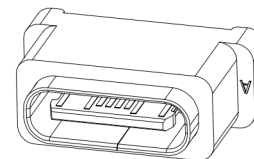
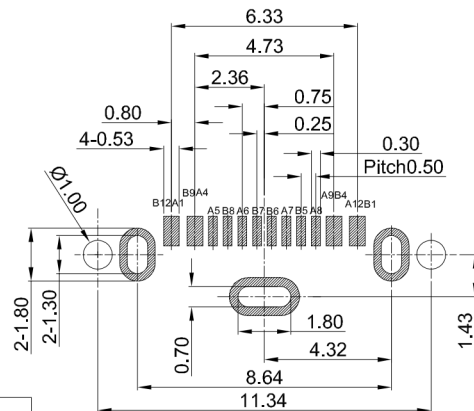
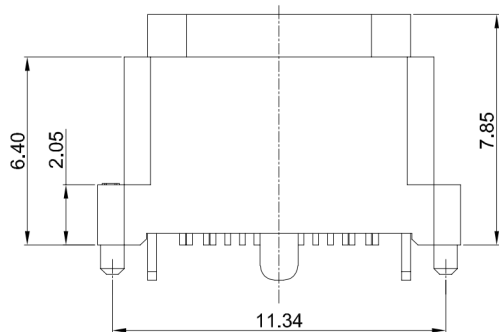

A1	A2	A3	A4	A5	A6	A7	A8	A9	A10	A11	A12
GND			VBUS	CC1	D+	D-	SBU1	VBUS			GND
First			First	Second	Second	Second	Second	First			First
B12	B11	B10	B9	B8	B7	B6	B5	B4	B3	B2	B1
GND			VBUS	SBU2	D-	D+	CC2	VBUS			GND
First			First	Second	Second	Second	Second	First			First

1	SHEATH	HIGH TEMPERATURE PLASTIC	BLACK
2	SHELL	STAINLESS STEEL	Ni PLATED
3	MID PLATE	STAINLESS STEEL	Ni PLATED
4	HOUSING	HIGH TEMPERATURE PLASTIC	BLACK UL 94 V-0
5	TERMINALS	HIGH CONDUCTIVITY COPPER	Au PLATING ON CONTACT AREA
6	WATERPROOF RING	SILICA GEL	BLACK
7	CAP	HIGH TEMPERATURE PLASTIC	BLACK UL 94 V-0
NO.	PARTS	MATERIAL	REMARKS

RECOMMENDED PCB LAYOUT  
TOLERANCE:±0.05



SCALE: 1:1 UNIT: mm  
SIZE: A4

Unless otherwise General Tolerance:  
X. ±0.50  
X.x ±0.30  
X.xx ±0.20  
X.xxx ±0.05  
X° ±3°

Title: Vertical Type-c 16P Female DIP H=7.85mm			
Molde Code: GT-USB-7073A			
DRAWN	CHECKED	APPROVED	DATE
Xia	Chen	Chen	2023.02.01



REV: A0 SHEET: 1/1

## X-ON Electronics

Largest Supplier of Electrical and Electronic Components

*Click to view similar products for [USB Connectors](#) category:*

*Click to view products by [G-Switch](#) manufacturer:*

Other Similar products are found below :

[950](#) [A-USB A-LP-SMT-C](#) [A-USB B-TOP-C](#) [MUSBD11135](#) [17-200721](#) [217450-1](#) [KMBVX-TH-5S-B30](#) [KUSBX-AS2N-W](#) [KUSBX-SMT2AP1S-W30](#) [935](#) [957](#) [30-498-6](#) [SK-60A-2](#) [1734082-1](#) [30-470](#) [30-489](#) [30-541](#) [MIKROE-1451](#) [USBFTVSCCG](#) [1-1734084-2](#) [10135326-001LF](#) [4198](#) [USB-A-D-VT](#) [USB-A-S-RA-TSMT](#) [1310-1023-02](#) [690-024-633-031](#) [UB-20PMFP-LC7001](#) [17-200011](#) [UB-20AFMM-LL7A01](#) [1040870124](#) [CAP-WCCMLPB1](#) [2274475-3](#) [UB-20BMFA-SL8001](#) [914-614A2025S10200](#) [ZX40-B-5S-1500-STDA\(30\)](#) [GSB3116344HR](#) [USB3FTV2SAZNF459](#) [U221-041N-1WVS62-F5D](#) [HYCW153-USBD05-500B](#) [HYCW219-USBD05-075B](#) [HYCW148-USBD05-117B](#) [HYCW149-USBD05-740B](#) [HYCW204-USBD05-108B](#) [HYCW214-USBA04-113B](#) [HYCW213-USBA04-113B](#) [UB-20AMFM-SL7A01](#) [KMMX-BSMT35S-1-B30TR](#) [2345986-1](#) [10082141-N340LF](#) [10117836-011LF](#)