

SECTION A-A(剖视图A-A)
SCALE 2:1 (比例 2:1)

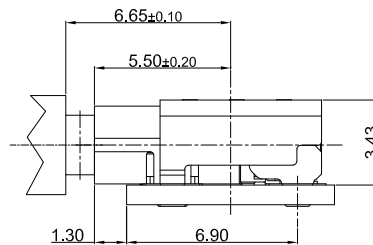

MATED CONDITION(REF.)

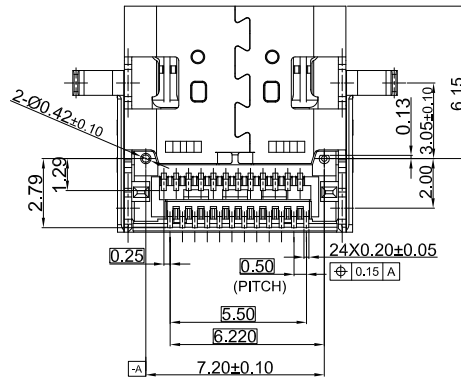
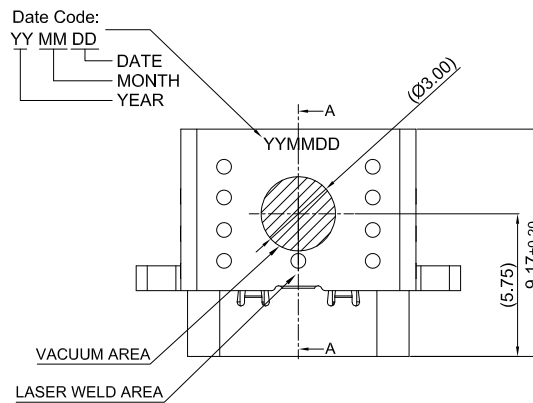

NOTES

1. GENERAL SPECIFICATION:

1.1 COPLANARITY: 0.10 Max.

1.2 CURRENT RATING: 5A

1.3 CONTACT RESISTANCE: 40mΩ MAX (INITIAL).

INSULATION RESISTANCE:100MΩ Min

1.4 DIELECTRIC WITHSTANDING VOLTAGE: 100 VAC

1.5 MECHANICAL CHARACTERISTICS:

INSERTION FORCE: 5~20N EXTRACTION FORCE: 8~20N

AFTER DURABILITY EXTRACTION FORCE: 6~20N

1.6 Durability Cycle:10,000 cycle

1.7 Operating temperature: -40°C~+85°C

A1	A2	A3	A4	A5	A6	A7	A8	A9	A10	A11	A12
GND	TX1+	TX1-	VBUS	CC1	D+	D-	SBU1	VBUS	RX2-	RX2+	GND
B12	B11	B10	B9	B8	B7	B6	B5	B4	B3	B2	B1
6	OUT SHELL	1	SUS304	NICKEL PLATING				0.25mm			
5	INT SHELL	1	SUS304	NICKEL PLATING				0.3mm			
4	MAIN HOUSING	1	PAST HF 30%碳纤维, UL94 V-0, 黑色	-				COLOR:BLACK			
3	MID PLATE	1	SUS301	-				0.15mm			
2	BOTTOM TERMINAL	1	C18140	-				0.12mm			
1	TOP TERMINAL	1	C18140	-				MATING SIDE:SEE PART NO: SOLDER TAIL:GOLD FLASH, 30μ" NICKEL OVERALL. 0.12mm			
ITEM	DESCRIPTION	QTY	MATERIAL	FINISH				REMARK			

b-Switch 品赞科技®

Unless otherwise specified, Tolerance:

X. ±0.30
X.x ±0.20
X.xx ±0.15
X.xxx ±0.10
Angles ±3°

G-Switch Electronic (HongKong) CO.,Ltd.

DESIGN Li Qingqi	DATE 2022.04.23	Molde code:	
CHECKED	DATE	GT-USB-7088B	
APPROVED	DATE		
http://www.dg-switch.com		REV.: X1	SCALE: 4:1
TEL:0769-82388879		UNIT: mm	
		SIZE: A4	SHEET: 1/1



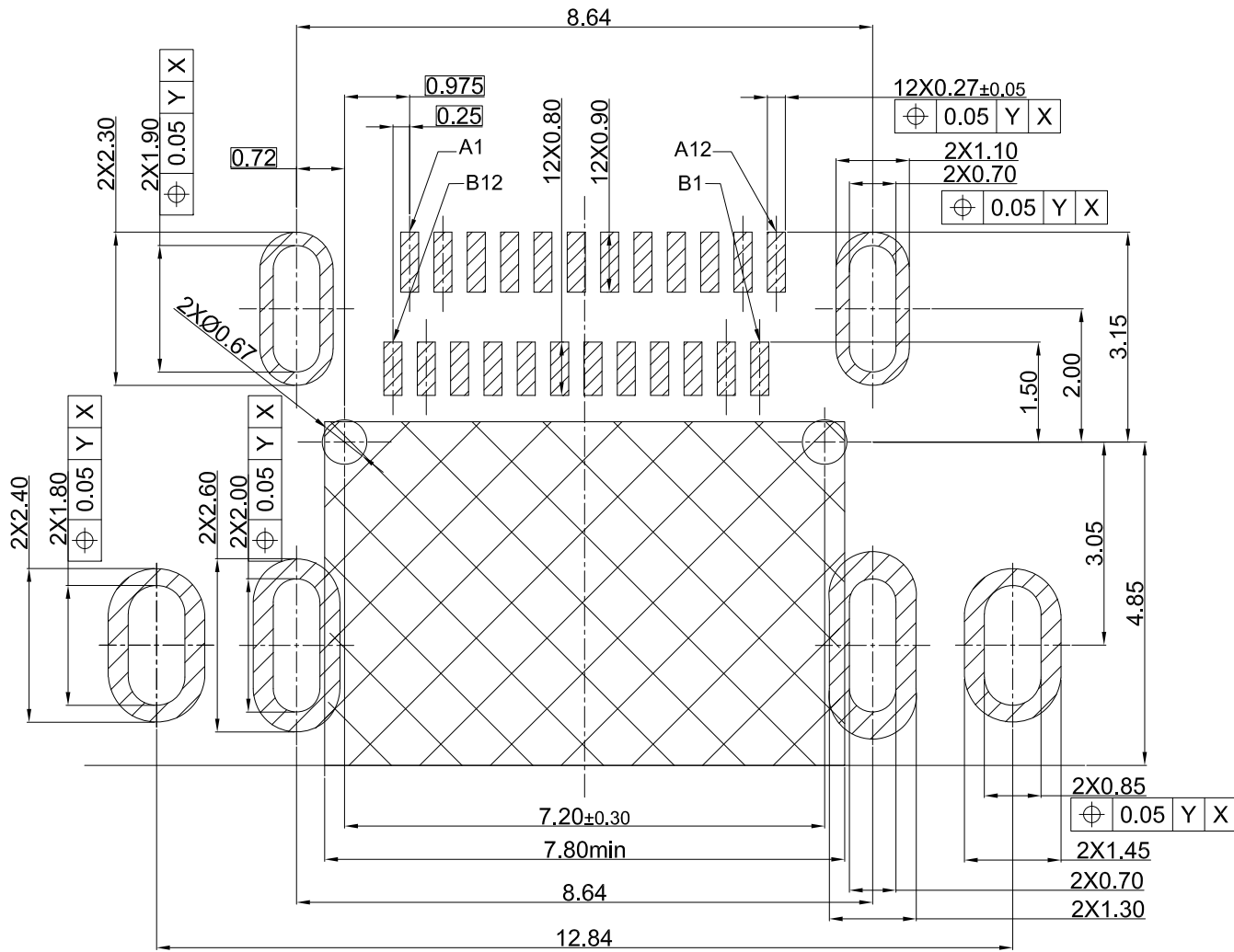

Recommended PCB Layout(Top View)/推荐的PCB布局(前视图)

General Tolerances:±0.05/一般公差:±0.05

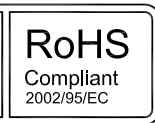
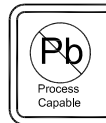

G-Switch Electronic (HongKong) CO.,Ltd.

Unless otherwise specified, Tolerance:
 X. ±0.30
 X.x ±0.20
 X.xx ±0.15
 X.xxx ±0.10
 Angles ±3°

DESIGN Li Qingqi DATE 2022.04.23
 CHECKED DATE
 APPROVED DATE
<http://www.dg-switch.com>
 TEL:0769-82388879

Molde code:
 GT-USB-7088B
 REV.: X1 SCALE: 4:1 UNIT: mm
 SIZE: A4 SHEET: 1/1

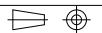

20PCS EMPTY 1000PCS PRODUCTS BEGINING PORTION 400mm MIN
20PCS EMPTY

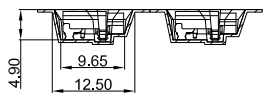
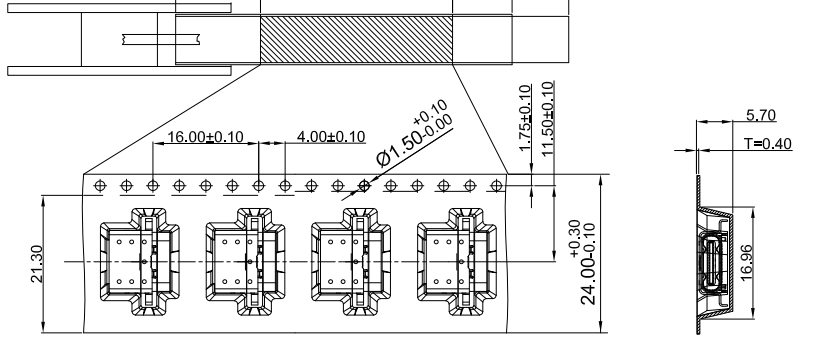

CUSTOMER UNWINDING DIRECTION

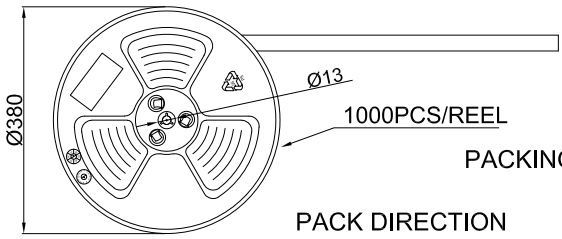

PACKING: 1. 1000 PCS/REEL.
2. 10 REEL/Carton

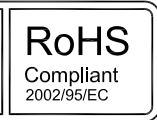
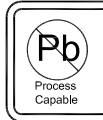
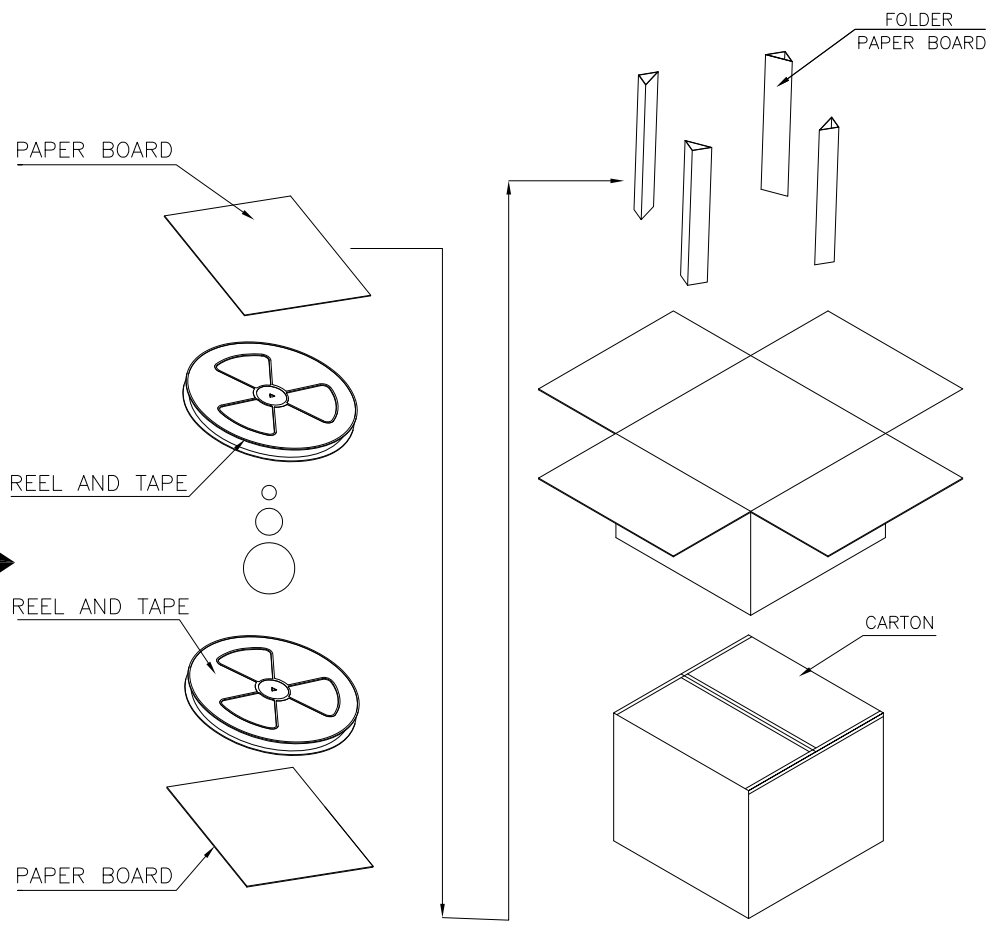
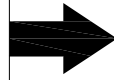

G-Switch Electronic (HongKong) CO.,Ltd.

Unless otherwise specified, Tolerance:
 X. ±0.30
 X.x ±0.20
 X.xx ±0.15
 X.xxx ±0.10
 Angles ±3°

DESIGN Li Qingqi DATE 2022.04.23
 CHECKED DATE
 APPROVED DATE
<http://www.dg-switch.com>
 TEL:0769-82388879

Molde code:
GT-USB-7088B
 REV.: X1 SCALE: 4:1 UNIT: mm
 SIZE: A4 SHEET: 1/1

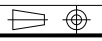

X-ON Electronics

Largest Supplier of Electrical and Electronic Components

Click to view similar products for [USB Connectors](#) category:

Click to view products by [G-Switch](#) manufacturer:

Other Similar products are found below :

[950](#) [A-USB B-TOP-C](#) [MUSBA511N5](#) [MUSBC111M5](#) [MUSBD11135](#) [17-200721](#) [217450-1](#) [KMBVX-TH-5S-B30](#) [896-30-004-00-000000](#)
[KUSBX-AS2N-W](#) [KUSBX-SMT2AP1S-W30](#) [935](#) [957](#) [30-498-6](#) [SK-60A-2](#) [1734082-1](#) [30-1574](#) [30-470](#) [30-489](#) [30-541](#) [30-572-3](#) [A-USB](#)
[A-2P-C](#) [MIKROE-1451](#) [USBFTV2PEM2G](#) [USBFTVSCCG](#) [4689-1](#) [1-1734084-2](#) [MUSBC11135](#) [USBF21ZNSCC](#) [USBBFTV6ZC](#)
[MUSBB151341](#) [10135326-001LF](#) [M9177/3-1](#) [TJ-105](#) [USB-A-S-F-B-VT](#) [4198](#) [690-024-633-031](#) [UB-20PMFP-LC7001](#) [USBFTVC6MRG](#)
[UA-20BMFA-SL8001](#) [17-200011](#) [USBFTVC7ZC](#) [UB-20AFMM-LL7A01](#) [USBFTVC2MN](#) [CAP-WCCMLPB1](#) [1310-1031-01](#) [2041386-1](#)
[2274475-3](#) [UB-20BMFA-SL8001](#) [UB-20PMFP-SC8003](#)