

1

2

3

4

5

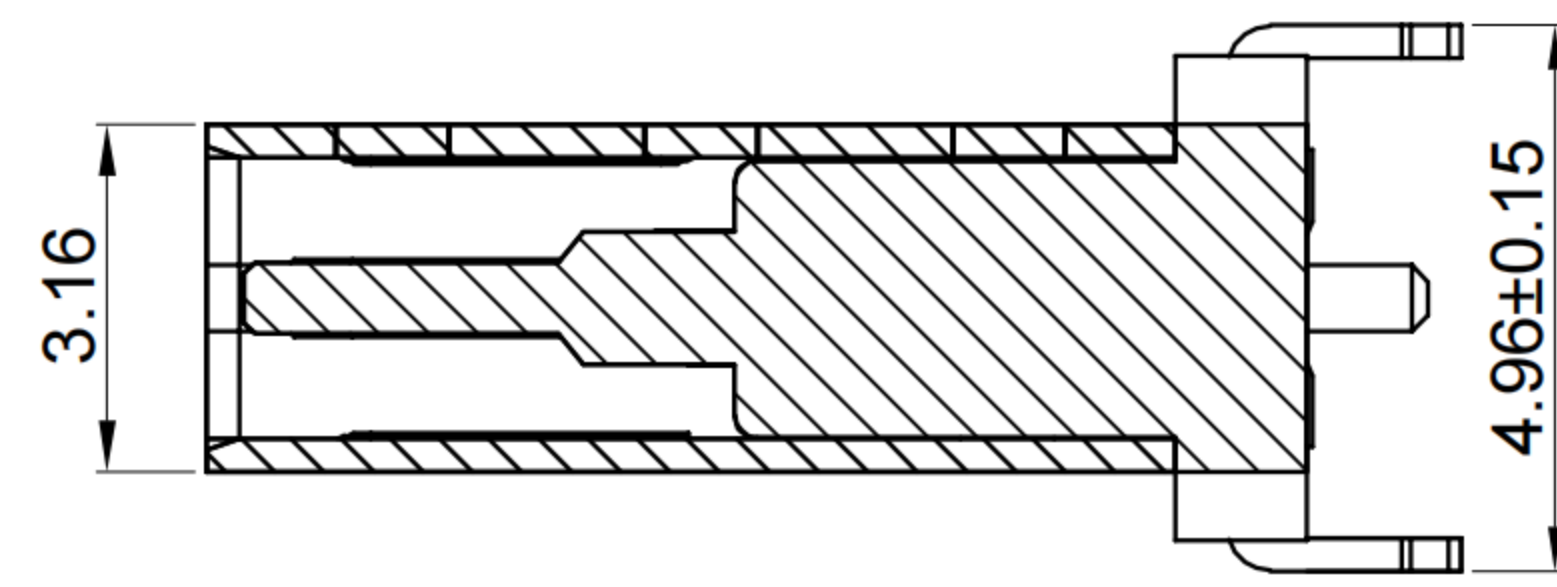
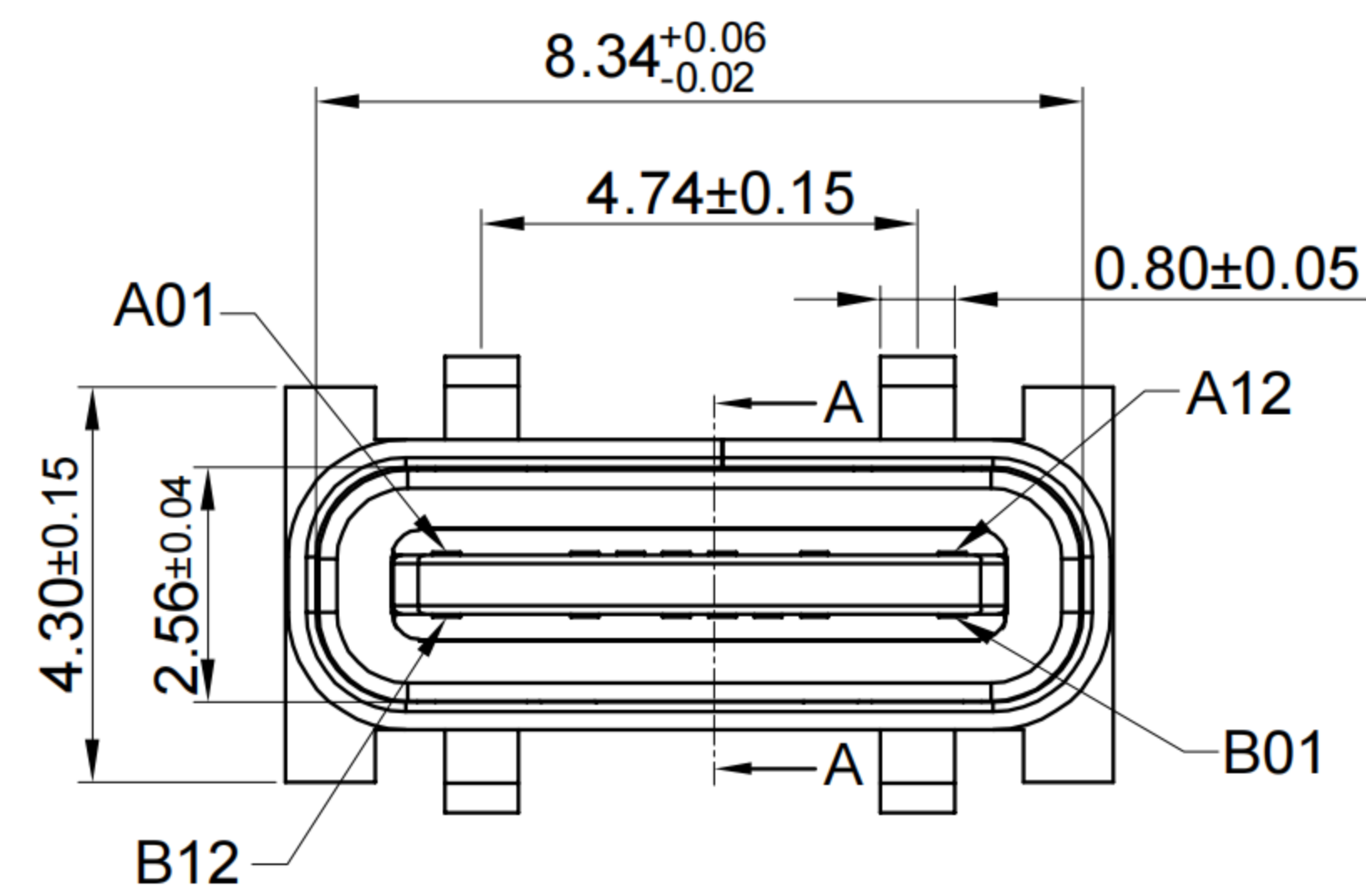

SECTION A-A

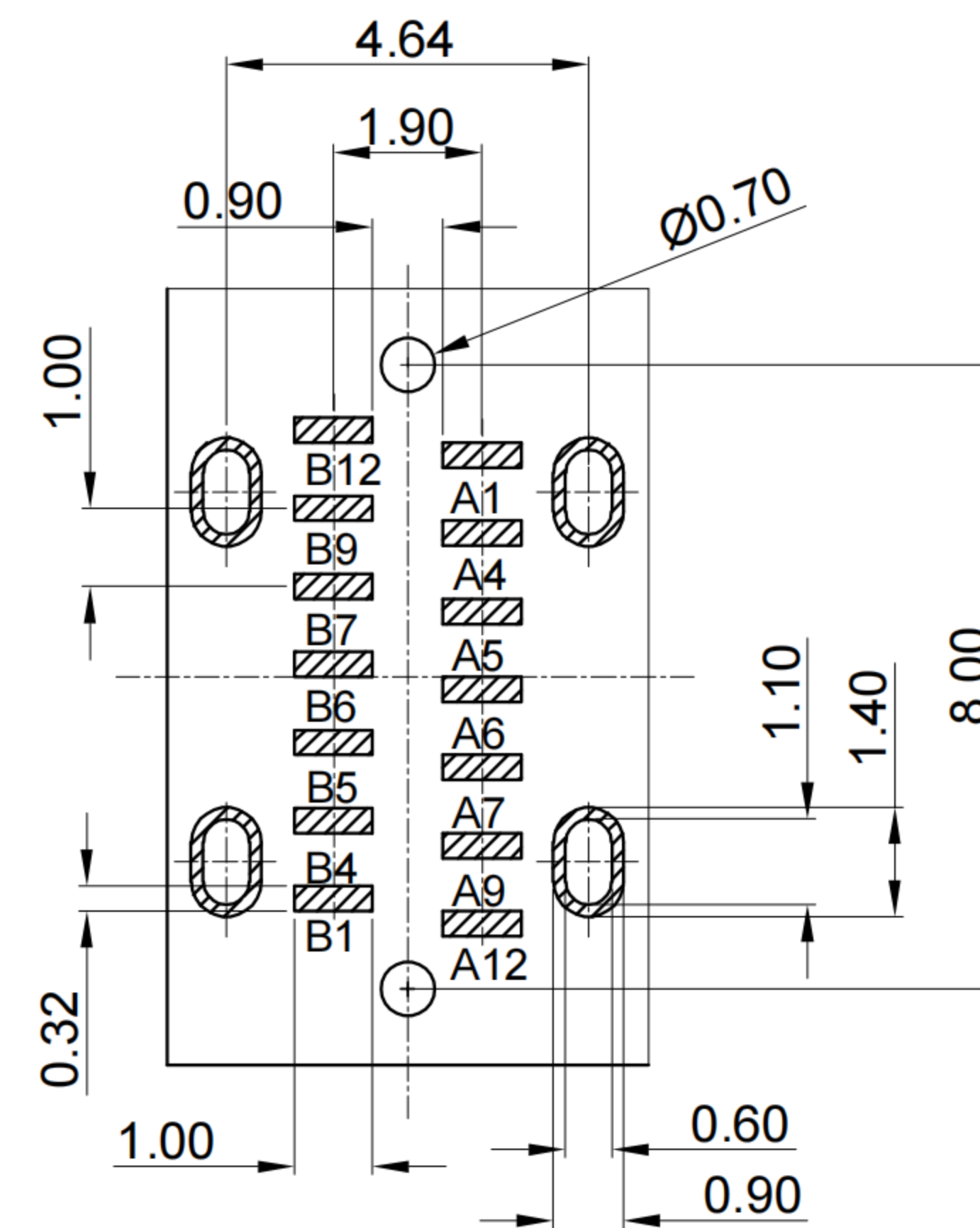
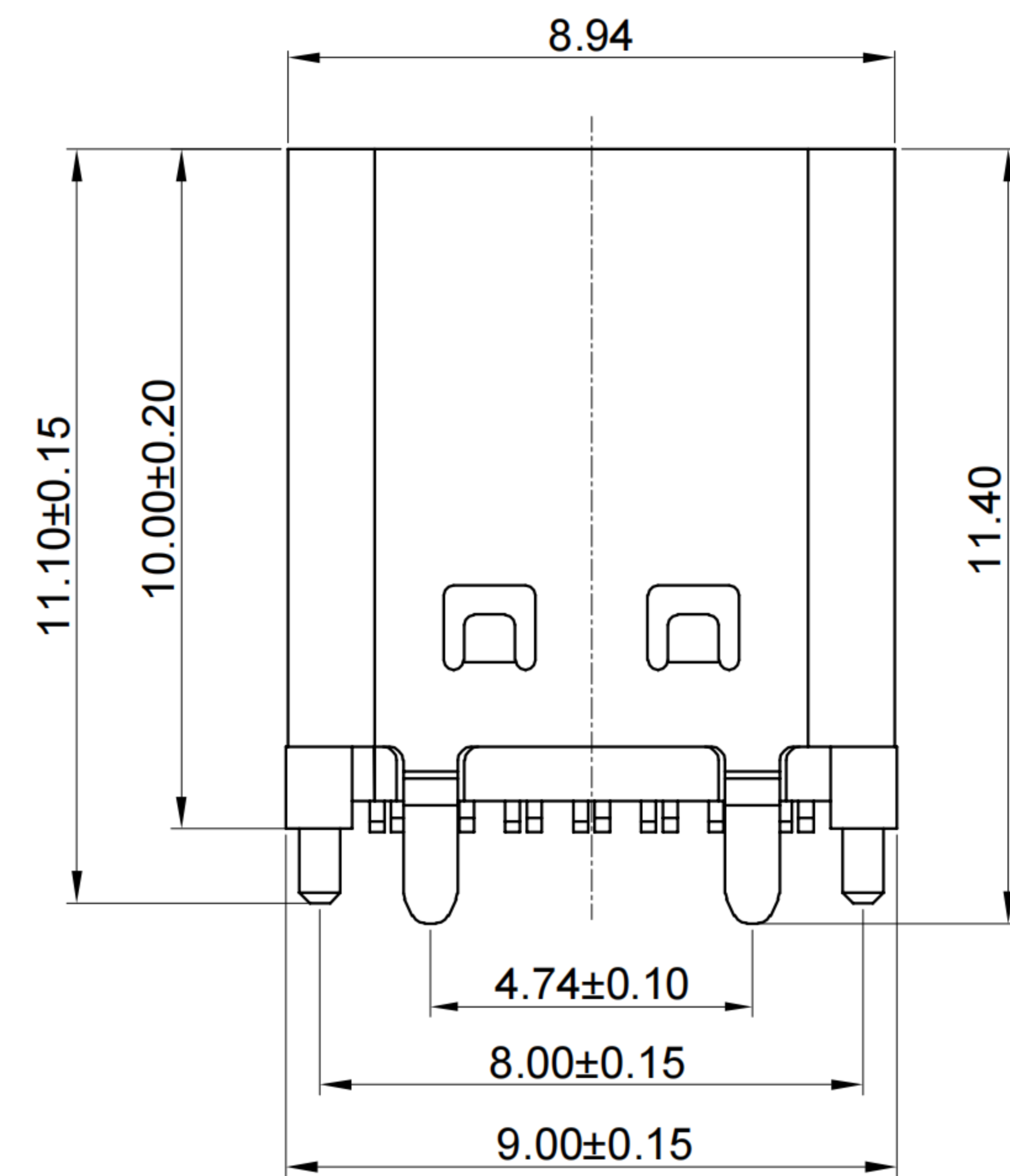
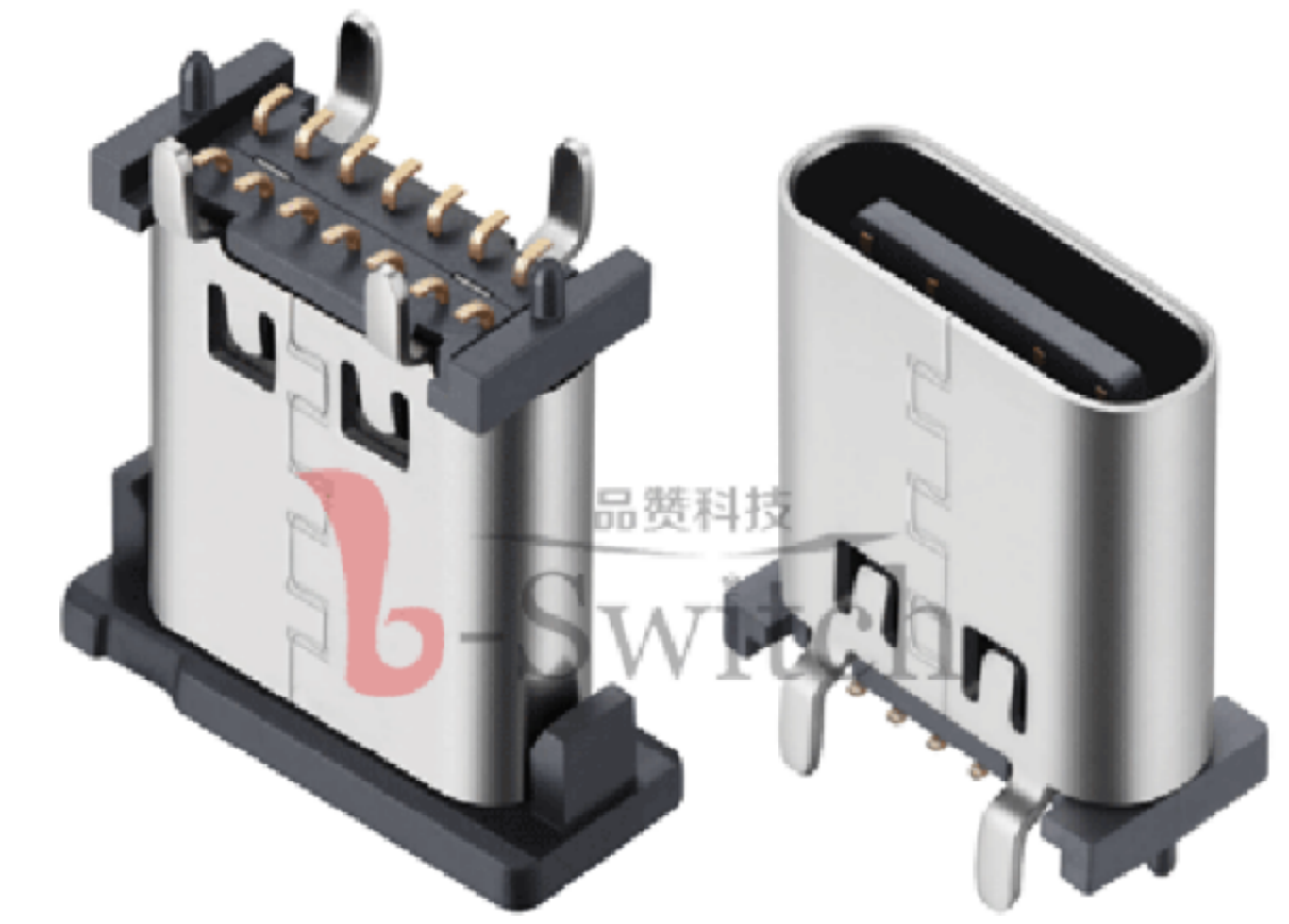
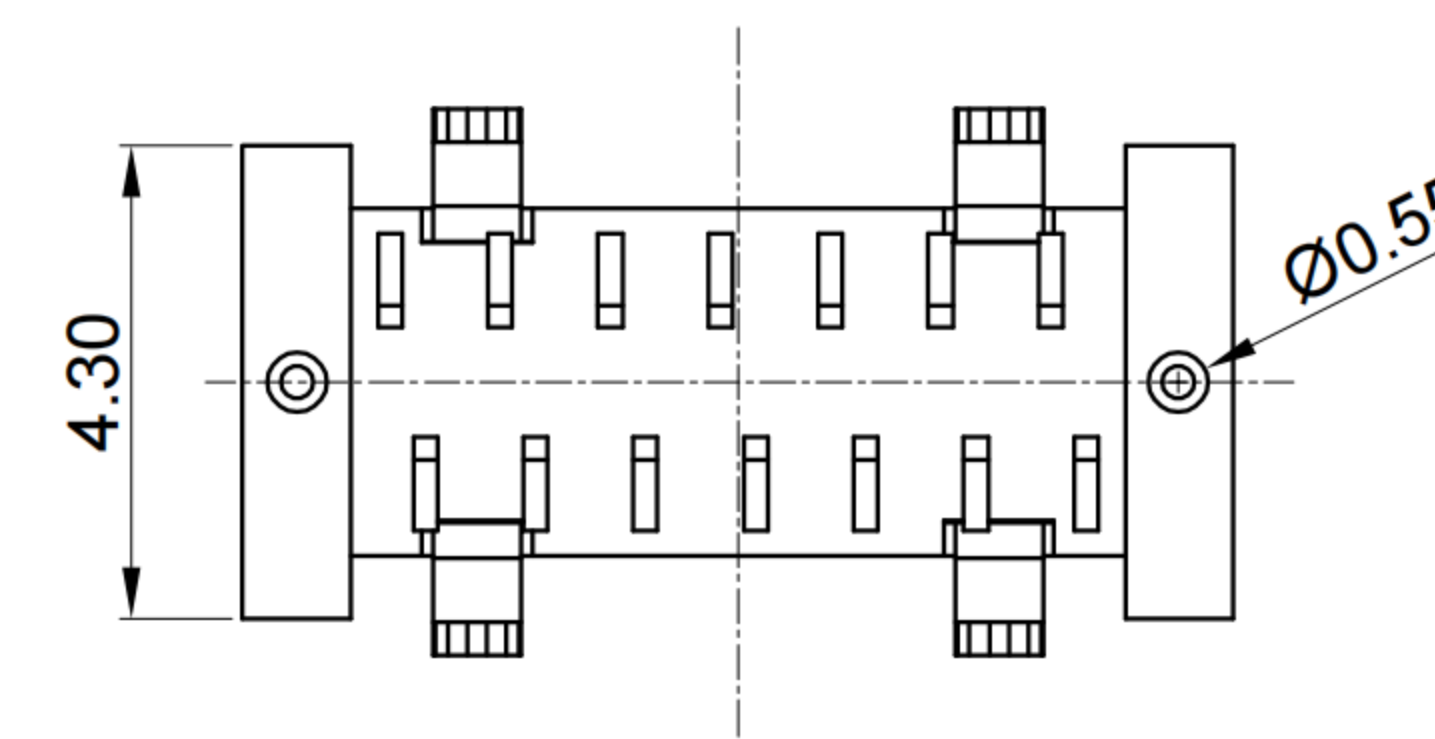

RECOMMENDED PCB LAYOUT  
TOLERANCE: ±0.05

**G-Switch USB-C Specification:**

1. Current rating: 3A on Vbus/1.25A on Vconn/0.25A on other
- Voltage rating: 24V AC
2. Dielectric Voltage: 100V AC/minute
3. Contact resistance: 40mΩ Max
4. Insulation resistance: 100MΩ Min
5. Temperature range: -55 °C ~ +85 °C
6. Mating force: 5N~20N
7. Unmating force: 8N~20N
8. Durability: 10,000 Cycles

A1	A2	A3	A4	A5	A6	A7	A8	A9	A10	A11	A12
GND			VBUS	CC1	D+	D-		VBUS			GND
First			First	Second	Second	Second		First			First
B12	B11	B10	B9	B8	B7	B6	B5	B4	B3	B2	B1
GND			VBUS		D-	D+	CC2	VBUS			GND
First			First		Second	Second	Second	First			First

1	SHELL	STAINLESS STEEL	NI PLATED
2	HOUSING	HIGH TEMPERATURE PLASTIC	BLACK UL 94 V-0
3	TERMINALS	COPPER ALLOY	Au PLATING ON CONTACT AREA
4	CAP	HIGH TEMPERATURE PLASTIC	BLACK UL 94 V-0
NO.	PARTS	MATERIAL	REMARKS

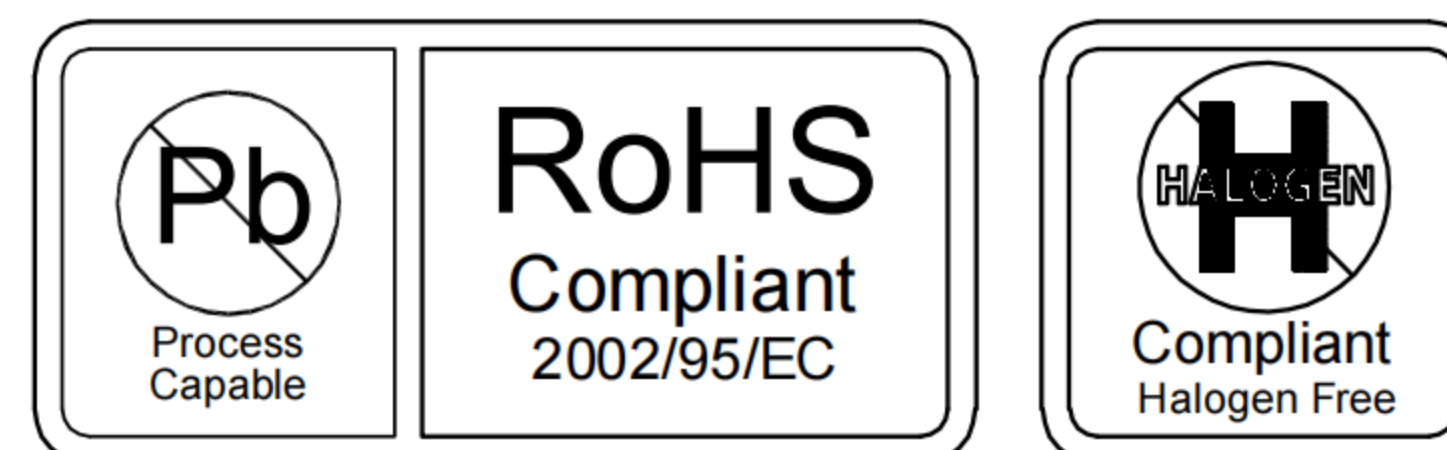

SCALE: 4:1	UNIT: mm	Title: Vertical Type-c 14P Female SMT L=10.0mm			
SIZE: A4		Molde Code: GT-USB-7090B			
Unless otherwise General Tolerance:		DRAWN	CHECKED	APPROVED	DATE
X.	±0.20	Xia	Chen	Chen	2022.11.21
X.x	±0.15				
X.xx	±0.10				
X.xxx	±0.05				
Angles	±3°				
		REV: A0		SHEET: 1/1	



## X-ON Electronics

Largest Supplier of Electrical and Electronic Components

*Click to view similar products for [USB Connectors](#) category:*

*Click to view products by [G-Switch](#) manufacturer:*

Other Similar products are found below :

[950](#) [MUSBD11135](#) [17-200721](#) [217450-1](#) [KMBVX-TH-5S-B30](#) [KUSBX-AS2N-W](#) [KUSBX-SMT2AP1S-W30](#) [935](#) [957](#) [30-498-6](#) [SK-60A-2](#)  
[1734082-1](#) [30-470](#) [30-489](#) [30-541](#) [A-USB A-2P-C](#) [MIKROE-1451](#) [USBFTVSCCG](#) [1-1734084-2](#) [10135326-001LF](#) [4198](#) [USB-A-D-VT](#)  
[USB-A-S-RA-TSMT](#) [1310-1023-02](#) [690-024-633-031](#) [UB-20PMFP-LC7001](#) [17-200011](#) [UB-20AFMM-LL7A01](#) [1040870124](#) [CAP-](#)  
[WCCMLPB1](#) [CAP-WCCMLPC1](#) [2274475-3](#) [UB-20BMFA-SL8001](#) [914-614A2025S10200](#) [USB3FTV7SAGF059](#) [ZX40-B-5S-1500-](#)  
[STDA\(30\)](#) [GSB3116344HR](#) [USB3FTV2SAZNF459](#) [USB3FTV7SAZNF459](#) [U221-041N-1WVS62-F5D](#) [HYCW153-USBD05-500B](#)  
[HYCW219-USBD05-075B](#) [HYCW148-USBD05-117B](#) [HYCW149-USBD05-740B](#) [HYCW204-USBD05-108B](#) [HYCW214-USBA04-113B](#)  
[HYCW213-USBA04-113B](#) [UB-20AMFM-SL7A01](#) [KMMX-BSMT35S-1-B30TR](#) [2345986-1](#)