

A B C D E

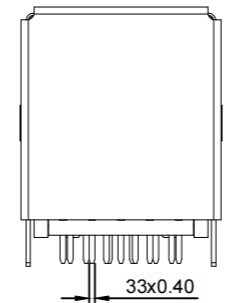

- G-Switch USB-A Specification:**
- 1.Current rated: 1.5A AT 250 VAC Min
  - 2.Withstanding voltage: 100V AC/minute
  - 3.Contact resistance: 30mΩ Max
  - 4.Insulation resistance: 100MΩ Min
- G-Switch USB-C Specification:**
- 1.Current rated: 5A on vbus/1.25A on vconn/0.25A on other
  - 2.Withstanding voltage: 100V AC/minute
  - 3.Contact resistance: 40mΩ Max
  - 4.Insulation resistance: 100MΩ Min
  - 5.Operating temperature: -40°C ~ +85°C
  - 6.Mating force: 5N~20N
  - 7.Unmating force: 8N~20N
  - 8.Durability cycle:10,000 cycles
  - 9.Data transmission rate up to 5Gbp/s

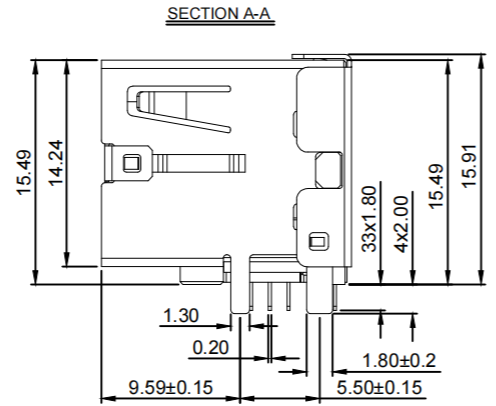
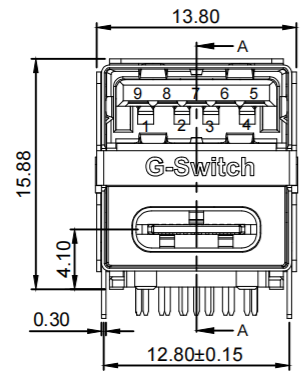
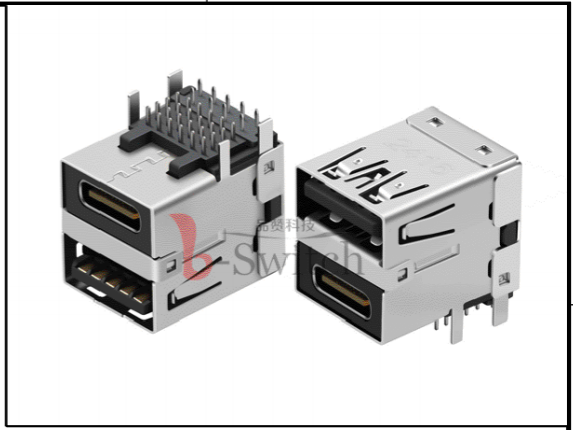
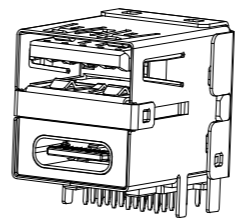
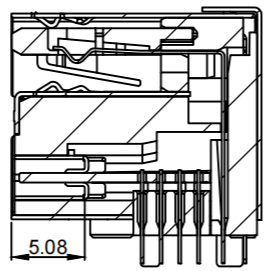
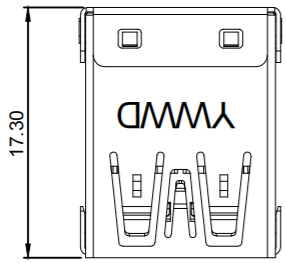
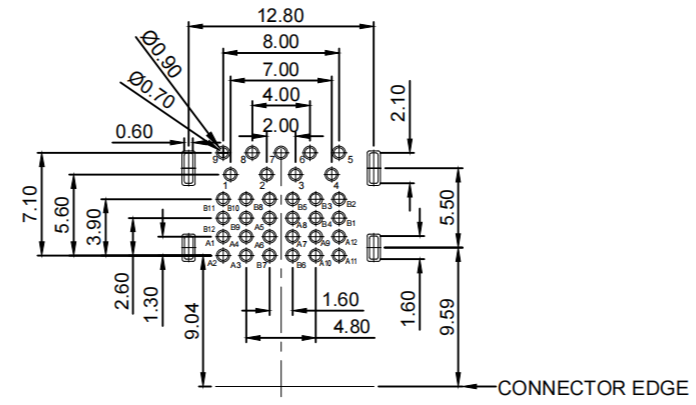
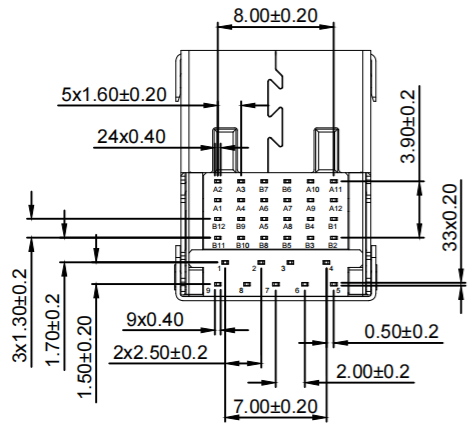

TYPE-A PIN DEFINE	1	2	3	4	5	6	7	8	9
	VBUS	D-	D+	GND	StdA_SSRX-	StdA_SSRX+	GND_DRAIN	StdA_SSTX-	StdA_SSTX+

A1	A2	A3	A4	A5	A6	A7	A8	A9	A10	A11	A12
GND	TX1+	TX1-	VBUS	CC1	D+	D-	SBU1	VBUS	RX2-	RX2+	GND
First	Second	Second	First	Second	Second	Second	Second	First	Second	Second	First

TYPE-C PIN DEFINE

B12	B11	B10	B9	B8	B7	B6	B5	B4	B3	B2	B1
GND	RX1+	RX1-	VBUS	SBU2	D-	D+	CC2	VBUS	TX2-	TX2+	GND
First	Second	Second	First	Second	Second	Second	Second	First	Second	Second	First

NO.	PARTS	MATERIAL	REMARKS
1	FRONT SHELL	STAINLESS STEEL	Ni PLATED
2	AFTER SHELL	STAINLESS STEEL	Ni PLATED
3	MIDDLE SHELL	STAINLESS STEEL	Ni PLATED
4	GND PLATE	STAINLESS STEEL	Ni PLATED
5	MID PLATE	STAINLESS STEEL	Ni PLATED
6	HOUSING	HIGH TEMPERATURE PLASTIC	BLACK UL 94 V-0
7	TERMINALS	COPPER ALLOY	Au PLATING ON CONTACT AREA

RECOMMENDED PCB LAYOUT  
TOLERANCE:±0.05



SCALE: 1:1	UNIT: mm	Title: Horizontal Type-A 9Pin+Type-C 24P Female DIP CH=4.1 L=17.3mm			
SIZE: A4		Molde Code: GT-USB-7106A			
Unless otherwise General Tolerance:		DRAWN	CHECKED	APPROVED	DATE
X	/	Xia	Chen	Chen	2023.02.01
X.x	±0.30				
X.xx	±0.25				
X.xxx	±0.20				
X*	±5°				



REV: A0 SHEET: 1/1

A B C D E

## X-ON Electronics

Largest Supplier of Electrical and Electronic Components

*Click to view similar products for [USB Connectors](#) category:*

*Click to view products by [G-Switch](#) manufacturer:*

Other Similar products are found below :

[950](#) [MUSBD11135](#) [17-200721](#) [217450-1](#) [KMBVX-TH-5S-B30](#) [KUSBX-AS2N-W](#) [KUSBX-SMT2AP1S-W30](#) [935](#) [957](#) [30-498-6](#) [SK-60A-2](#)  
[1734082-1](#) [30-470](#) [30-489](#) [30-541](#) [A-USB A-2P-C](#) [MIKROE-1451](#) [USBFTVSCCG](#) [1-1734084-2](#) [10135326-001LF](#) [4198](#) [USB-A-D-VT](#)  
[USB-A-S-RA-TSMT](#) [1310-1023-02](#) [690-024-633-031](#) [UB-20PMFP-LC7001](#) [17-200011](#) [UB-20AFMM-LL7A01](#) [1040870124](#) [CAP-](#)  
[WCCMLPB1](#) [CAP-WCCMLPC1](#) [2274475-3](#) [UB-20BMFA-SL8001](#) [914-614A2025S10200](#) [USB3FTV7SAGF059](#) [ZX40-B-5S-1500-](#)  
[STDA\(30\)](#) [GSB3116344HR](#) [USB3FTV2SAZNF459](#) [USB3FTV7SAZNF459](#) [U221-041N-1WVS62-F5D](#) [HYCW153-USBD05-500B](#)  
[HYCW219-USBD05-075B](#) [HYCW148-USBD05-117B](#) [HYCW149-USBD05-740B](#) [HYCW204-USBD05-108B](#) [HYCW214-USBA04-113B](#)  
[HYCW213-USBA04-113B](#) [UB-20AMFM-SL7A01](#) [KMMX-BSMT35S-1-B30TR](#) [2345986-1](#)