

NOTE:
1. QUANTITY: 1000 PCS/REEL, 10000 PCS/CARTON.

此产品符合
USB协会认证
规范TID:7346

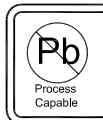

RoHS
Compliant
2002/95/EC



Pinzan Electronics (Dongguan) Co., Ltd.

Unless otherwise specified, Tolerance:
X. ±0.30
X.x ±0.20
X.xx ±0.15
X.xxx ±0.10
Angles ±3°

DESIGN Li Qingqi DATE 2021.11.11
Specifications
Type-C Receptacle 16pin sinking plate 0.8 integrated 7.35
<http://www.dg-switch.com>
TEL:0769-82388879

Molde code:
GT-USB-9014AB
REV.: X1 SCALE: 4:1 UNIT: mm
SIZE: A4 SHEET: 1/1

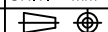

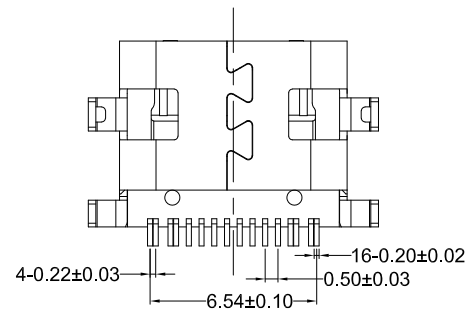
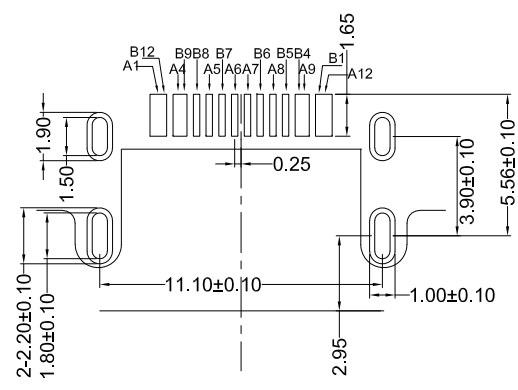
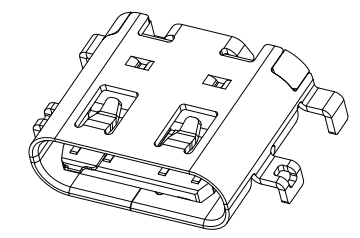
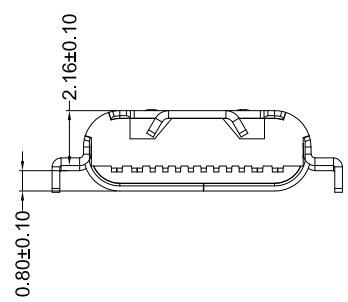
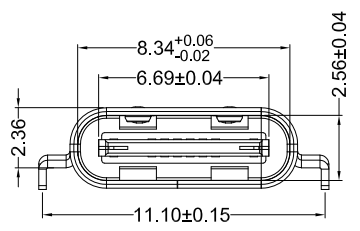
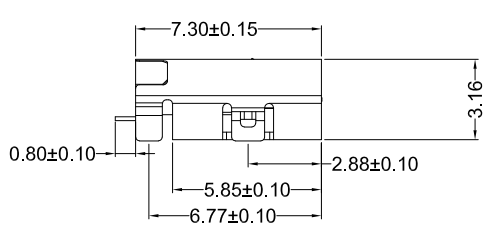
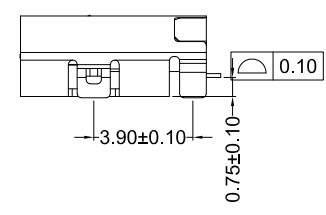
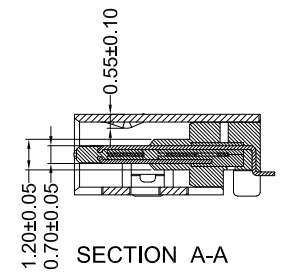
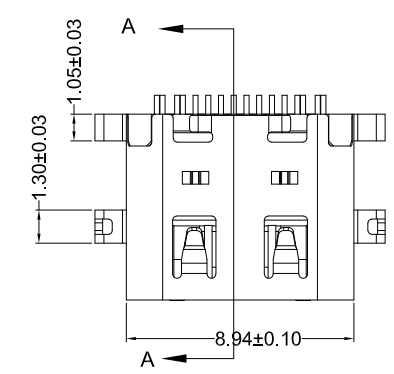

NOTES:

SPECIFICATION:

1. CURRENT RATING: 5.0A max
2. VOLTAGE: AC 100V
3. TEMPERATURE RANGE: -55°C ~ 85°C
4. CONTACT RESISTANCE: 40 MILLIONHM MAX
5. INSULATION RESISTANCE: 100 MEGOHMS MIN.
6. INSERTION FORCE : 5N~20N
7. UNMATING FORCE: 8N~20N
8. DURABILITY: 10,000 CYCLE

A1	GND	B12	GND
A2		B11	
A3		B10	
A4	VBUS	B9	VBUS
A5	CC1	B8	SBU2
A6	DP1	B7	DN2
A7	DN1	B6	DP2
A8	SBU1	B5	CC2
A9	VBUS	B4	VBUS
A10		B3	
A11		B2	
A12	GND	B1	GND

RECOMMENDED P.C.B. LAYOUT
TOLERANCE UNSPECIFIED ±0.05MM

此产品符合
USB协会认证
规范TID:7346

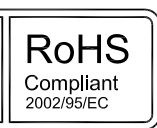
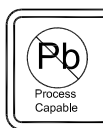

Pinzan Electronics (Dongguan) Co., Ltd.

Unless otherwise specified, Tolerance:
X. ±0.30
X.x ±0.20
X.xx ±0.15
X.xxx ±0.10
Angles ±3°

DESIGN Li Qingqi DATE 2021.11.11
Specifications Type-C Receptacle 16pin slinking plate 0.8 Integrated 7.35
<http://www.dg-switch.com>
TEL:0769-82388879

Molde code: GT-USB-9014AB
REV.: X1 SCALE: 4:1 UNIT: mm
SIZE: A4 SHEET: 1/1

X-ON Electronics

Largest Supplier of Electrical and Electronic Components

Click to view similar products for [USB Connectors](#) category:

Click to view products by [G-Switch](#) manufacturer:

Other Similar products are found below :

[950](#) [A-USB B-TOP-C](#) [MUSBA511N5](#) [MUSBC111M5](#) [MUSBD11135](#) [17-200721](#) [217450-1](#) [KMBVX-TH-5S-B30](#) [896-30-004-00-000000](#)
[KUSBX-AS2N-W](#) [KUSBX-SMT2AP1S-W30](#) [935](#) [957](#) [30-498-6](#) [SK-60A-2](#) [1734082-1](#) [30-1574](#) [30-470](#) [30-489](#) [30-541](#) [A-USB A-2P-C](#)
[MIKROE-1451](#) [USBFTV2PEM2G](#) [USBFTVSCCG](#) [4689-1](#) [1-1734084-2](#) [MUSBC11135](#) [USBF21ZNSCC](#) [USBBFTV6ZC](#) [MUSBB151341](#)
[10135326-001LF](#) [M9177/3-1](#) [TJ-105](#) [USB-A-S-F-B-VT](#) [4198](#) [690-024-633-031](#) [UB-20PMFP-LC7001](#) [USBFTVC6MRG](#) [UA-20BMFA-](#)
[SL8001](#) [17-200011](#) [USBFTVC7ZC](#) [UB-20AFMM-LL7A01](#) [USBFTVC2MN](#) [CAP-WCCMLPB1](#) [1310-1031-01](#) [2041386-1](#) [2274475-3](#) [UB-](#)
[20BMFA-SL8001](#) [UB-20PMFP-SC8003](#) [914-614A2025S10200](#)