



Product Description

GRF2133 is a broadband linear gain block featuring ultra-high gain and sub 0.85 dB noise figure for small cell, cellular booster, wireless infrastructure and other high performance applications.

Configured as a linear driver, LNA or cascaded gain block, it offers high levels of reuse both within a design and across platforms. The device is operated from a supply voltage of 1.8 to 5.0 V with a selectable I_{ddq} range of 35 to 120 mA for optimal efficiency and linearity.

Consult with the GRF applications engineering team for custom tuning/evaluation board data, device s-parameters and for applications with V_{dd} < 2.7 volts.

Features

Reference: 5.0V/60mA/700 MHz

- Gain: 40.0 dB
- OP1dB: 20.0 dBm
- OIP3: 31.0 dBm
- NF: 0.70 dB

Reference: 5.0V/60mA/1950 MHz

- Gain: 28.0 dB
- OP1dB: 20.0 dBm
- OIP3: 31.0 dBm
- NF: 0.60 dB

Reference: 5.0V/60mA/2500 MHz

- Gain: 23.5 dB
- OP1dB: 20.0 dBm
- OIP3: 30.0 dBm
- NF: 0.75dB
- Internally Matched
- Unconditionally Stable
- Flexible Biasing
- Process: GaAs pHEMT

Applications

- High Gain LNA
- Cellular Boosters / Repeaters
- Linear Driver Amplifier

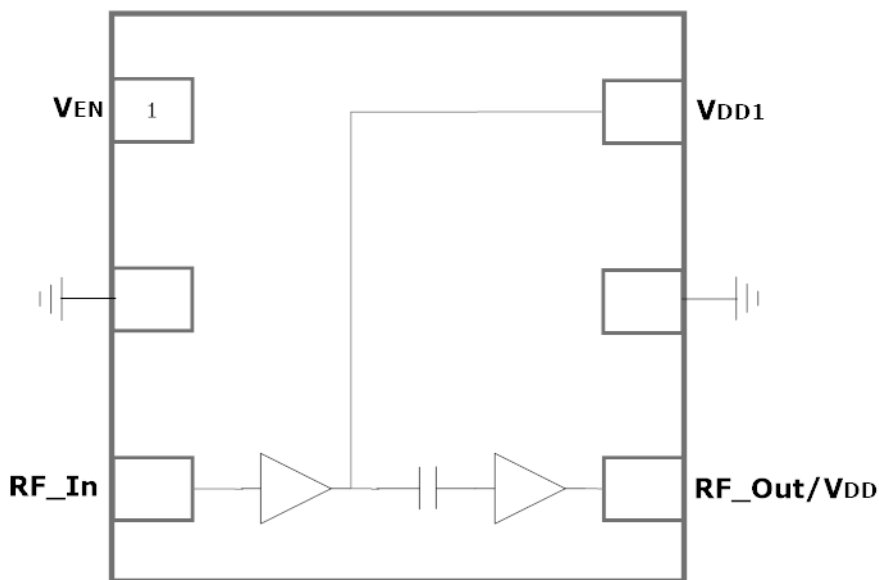

1.5 x 1.5 mm DFN-6

Absolute Ratings:

Parameter	Symbol	Min.	Max.	Unit
Supply Voltage	V _{DD}	0	6.0	V
RF Input Power: (Load VSWR < 2:1; V _D : 5.0 volts)	P _{IN MAX}		23	dBm
Operating Temperature (Package Heat Sink)	T _{AMB}	-40	105	°C
Maximum Channel Temperature (MTTF > 10 ⁶ Hours)	T _{MAX}		170	°C
Maximum Dissipated Power	P _{DISS MAX}		700	mW
Electrostatic Discharge:				
Charged Device Model:	CDM	1500		V
Human Body Model:	HBM	250		V
Storage:				
Storage Temperature	T _{STG}	-65	150	°C
Moisture Sensitivity Level	MSL		1	--



Caution! ESD Sensitive Device



Exceeding Absolute Maximum Rating conditions may cause permanent damage to the device.

Note: For manufacturing information, see the Guerrilla-RF.com website for the following document located on the GRF2133 landing page: Manufacturing Note—MN-001 Product Tape and Reel, Solderability and Package Outline Specification.

[Link to manufacturing note](#)

Pin Out (Top View)



Pin Assignments:

Pin	Name	Description	Note
1	V _{ENABLE}	Enable Voltage Input	V _{ENABLE} and series resistor set I _{DDQ} . V _{ENABLE} < 0.2 volts disables device. On-die pull-down resistor will turn the part off if this node is allowed to float.
2	NC	No Connect or Ground	No internal connection to die
3	RF_In	LNA RF input	External DC block required.
4	RF_Out/V _{DD}	LNA RF output	V _{DD} applied to this pin. External DC block required.
5	NC	No Connect or Ground	No internal connection to die
6	V _{DD1}	Bias Supply	Typically tied to V _{DD} via an external resistor or an inductor (for V _{DD} < 4.0 volts). Tying to V _{DD} allows for the re-use of M8 for the required de-coupling
PKG BASE	GND	Ground	Provides DC and RF ground for LNA, as well as thermal heat sink. Recommend multiple 8 mil vias beneath the package for optimal RF and thermal performance. Refer to evaluation board top layer graphic on schematic page.



Released

GRF2133

Ultra-High Gain LNA
Tuning Range: 0.1 to 2.7 GHz

Nominal Operating Parameters:

Parameter	Symbol	Specification			Unit	Condition
		Min.	Typ.	Max.		
Test Frequency	F _{TEST}		1950		MHz	V _{DD} = 5.0 V, T _A = 25 °C
Gain	S ₂₁	26.5	28.0		dB	
Output 3rd Order Intercept	OIP ₃		31.0		dBm	+2.0 dBm P _{OUT} per tone at 2 MHz Spacing (1949 and 1951 MHz)
Output 1dB Compression Power	OP _{1dB}	18.0	20.0		dBm	
Evaluation Board Noise Figure	NF		0.60	0.80	dB	
Switching Rise Time	T _{RISE}		10		us	
Switching Fall Time	T _{FALL}		200		ns	
Supply Current	I _{DD}		60		mA	
Enable Current	I _{ENABLE}		2.0		mA	
Disabled Mode						
Leakage Current	I _{LEAKAGE}		1		uA	V _{DD} : 5.0V; V _{ENABLE} : 0.0V
Thermal Data						
Thermal Resistance: (Infra-Red Scan)	Θ _{jc}		65		°C/W	On standard Evaluation Board
Channel Temperature @ +85 C Reference (Package heat sink)	T _{CHANNEL}		105 (See note)		°C	V _{DD} : 5.0 V; I _{DDQ} : 60 mA; No RF; P _{DISS} : 300 mW

Note: MTTF >10⁶ hours for T_{CHANNEL} <=170 degrees C.

GRF2133 Evaluation Board Performance; (5V/60 mA)

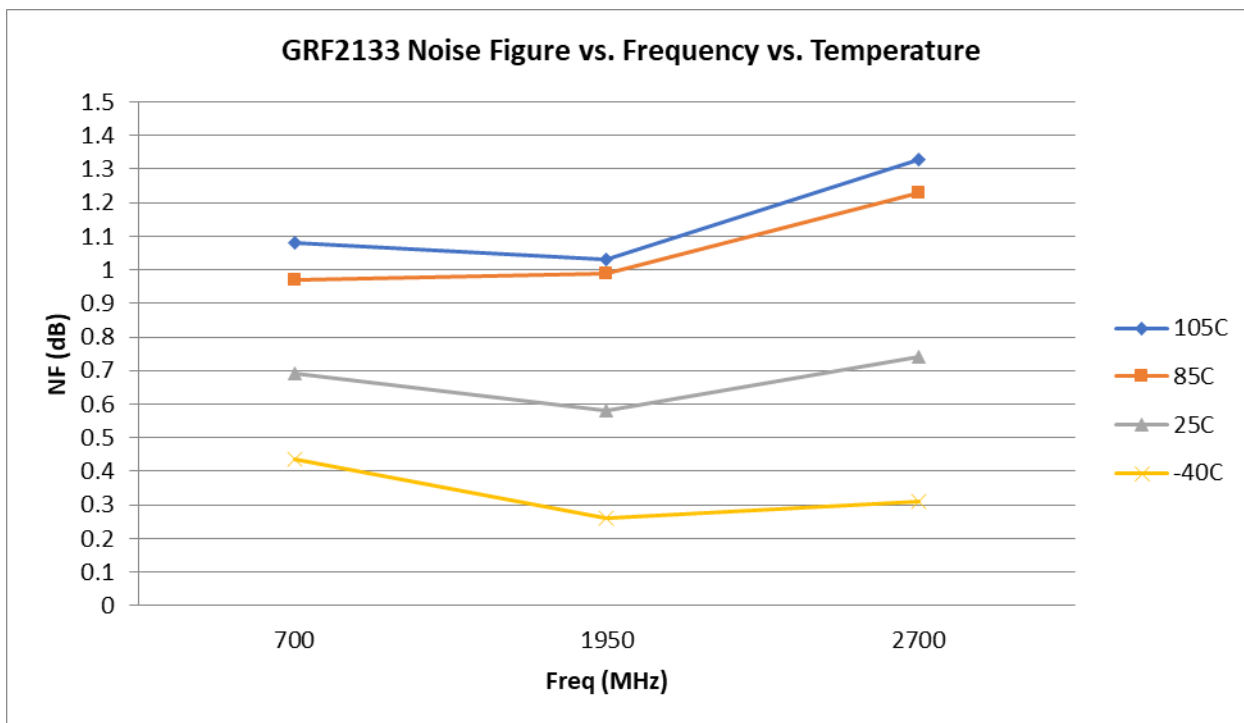
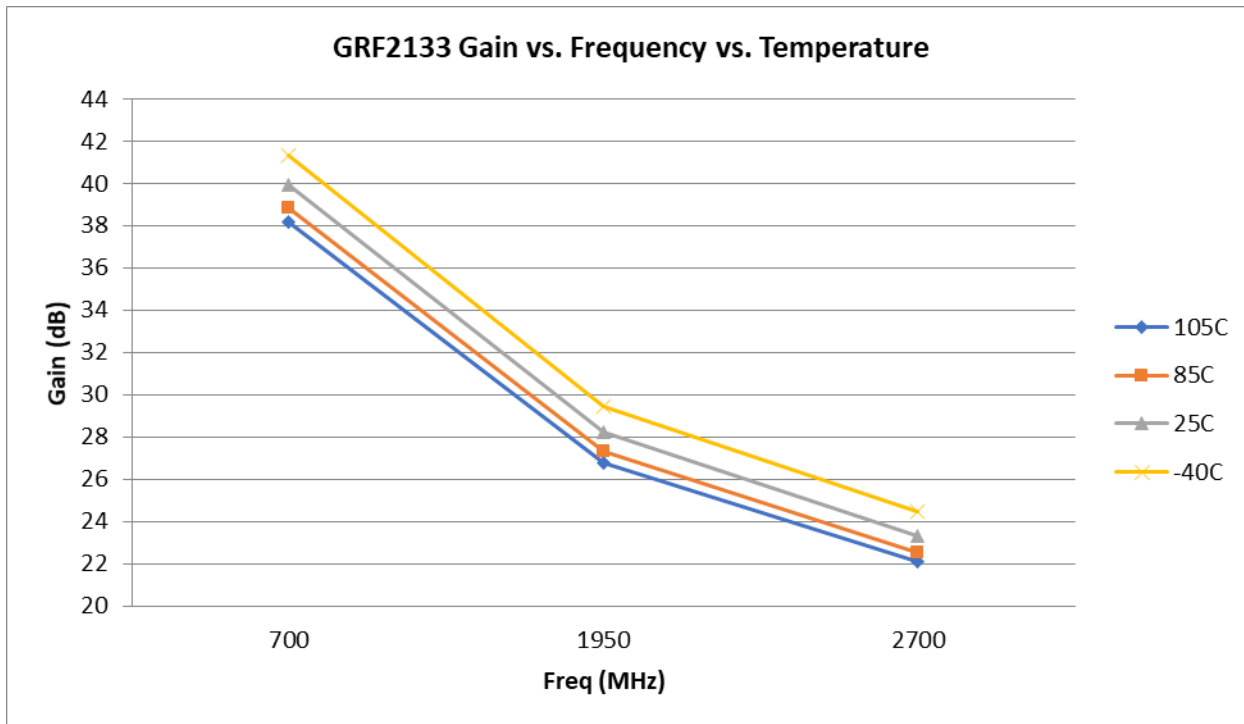

GRF2133 Evaluation Board Performance; (5V/60 mA)

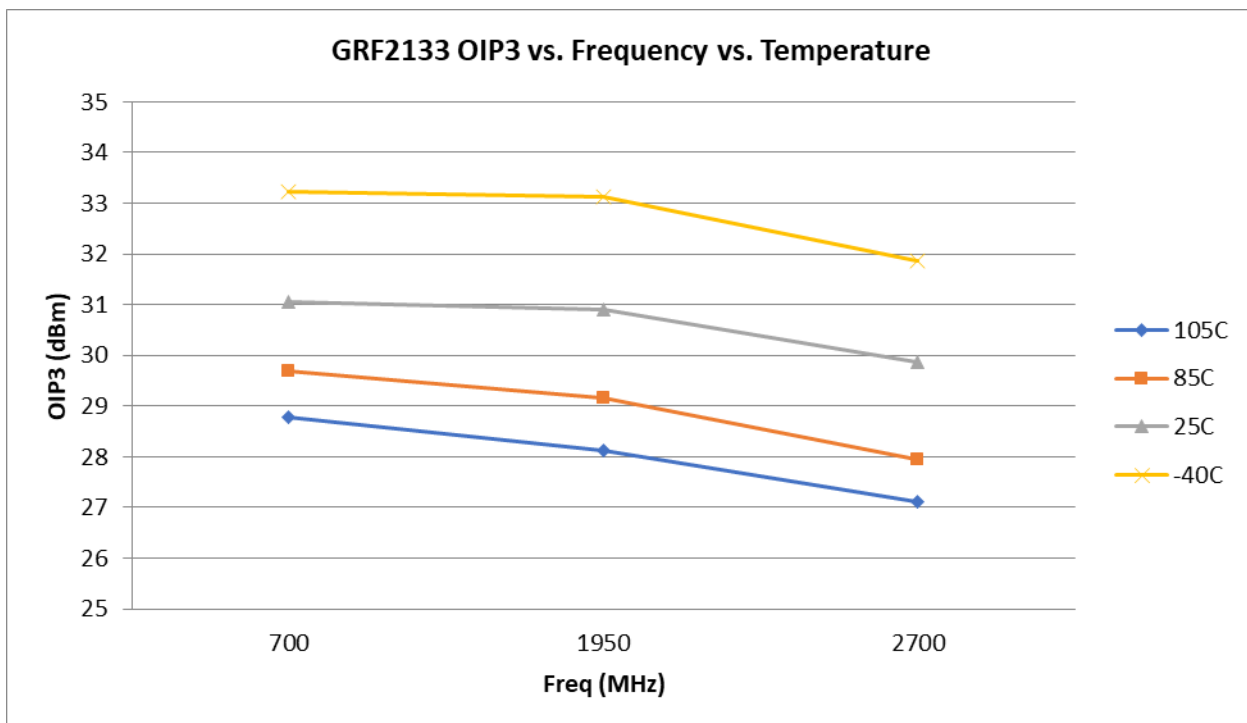
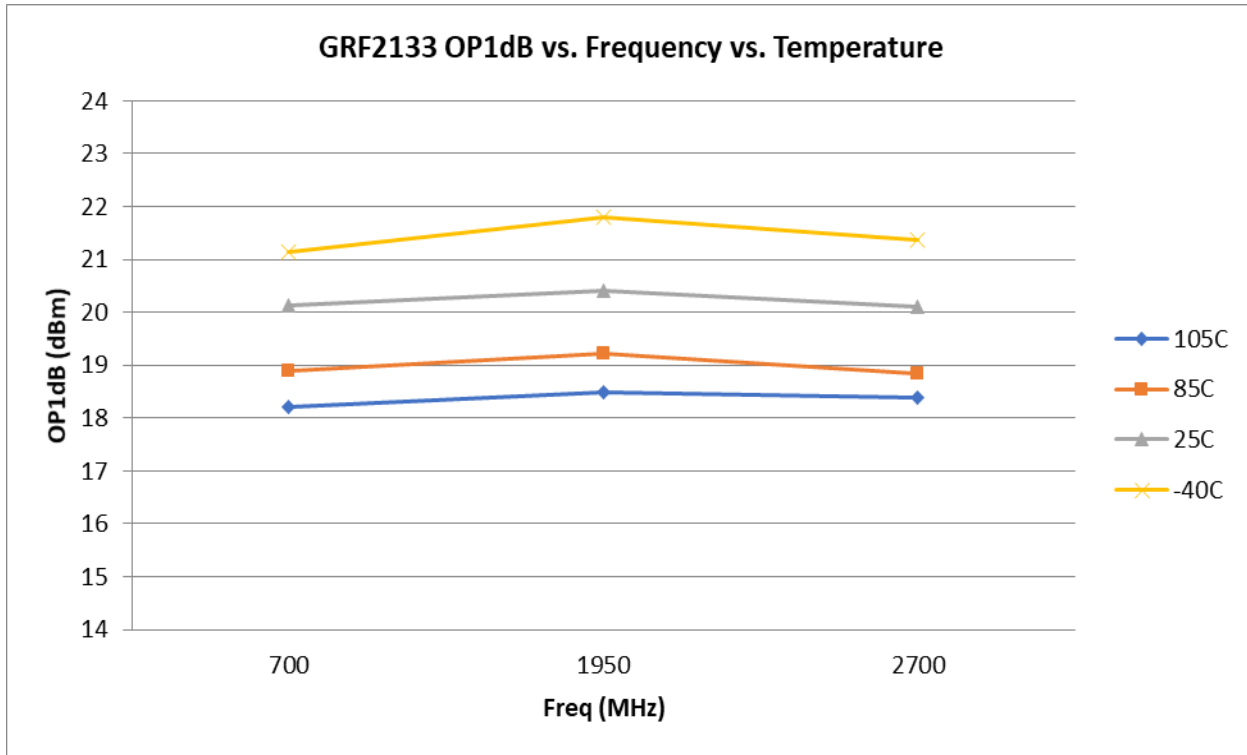

GRF2133 Evaluation Board Performance vs. Bias Current:

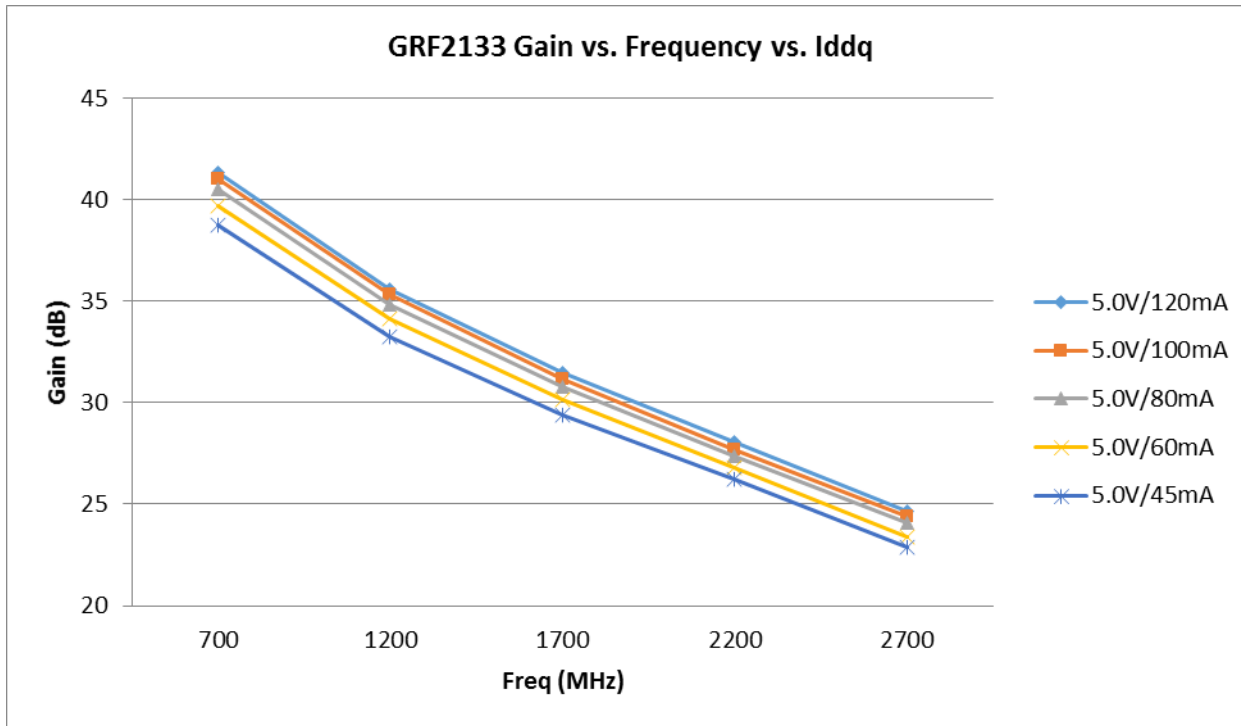

GRF2133 Evaluation Board Performance vs. Bias Current:

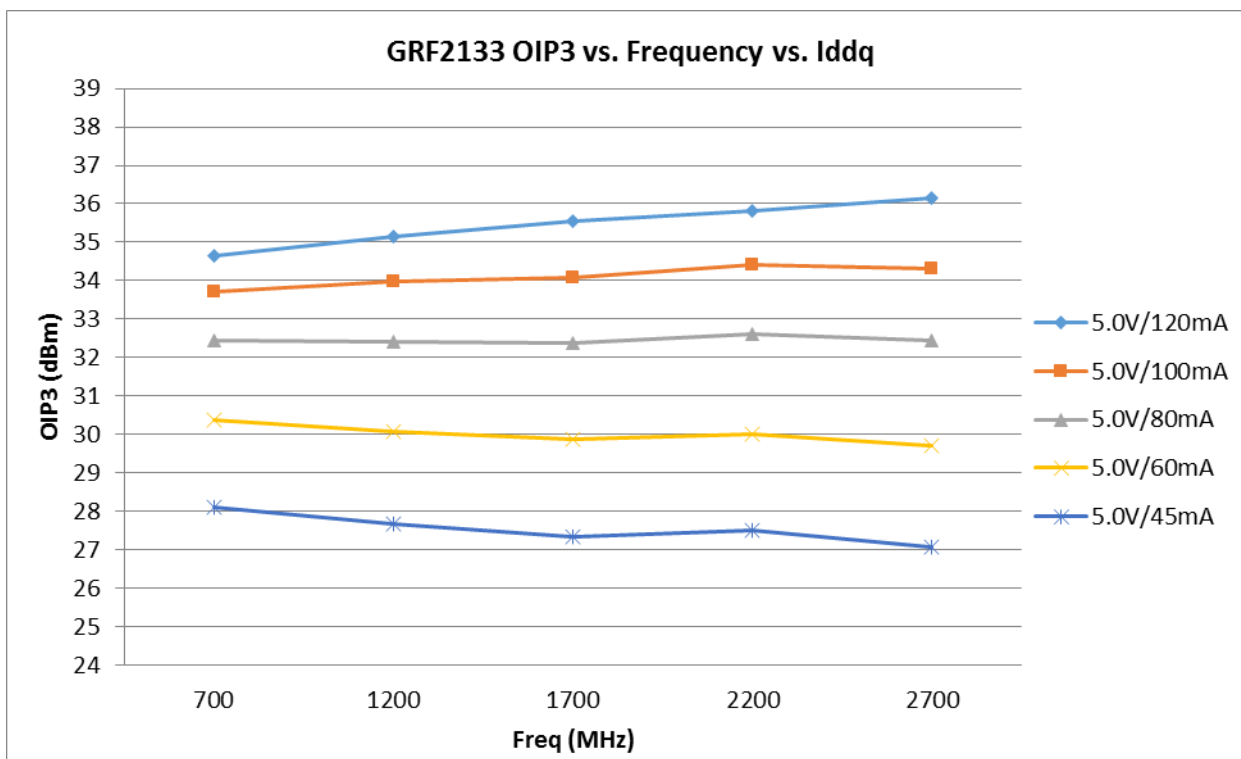
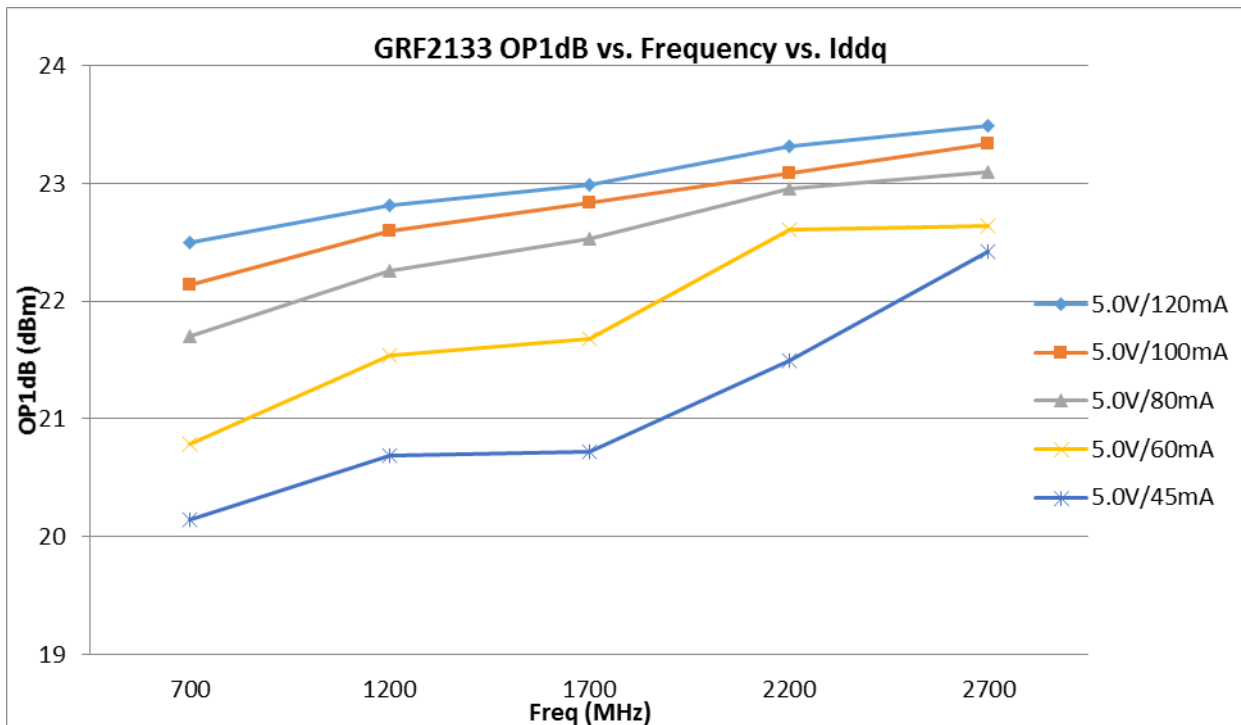

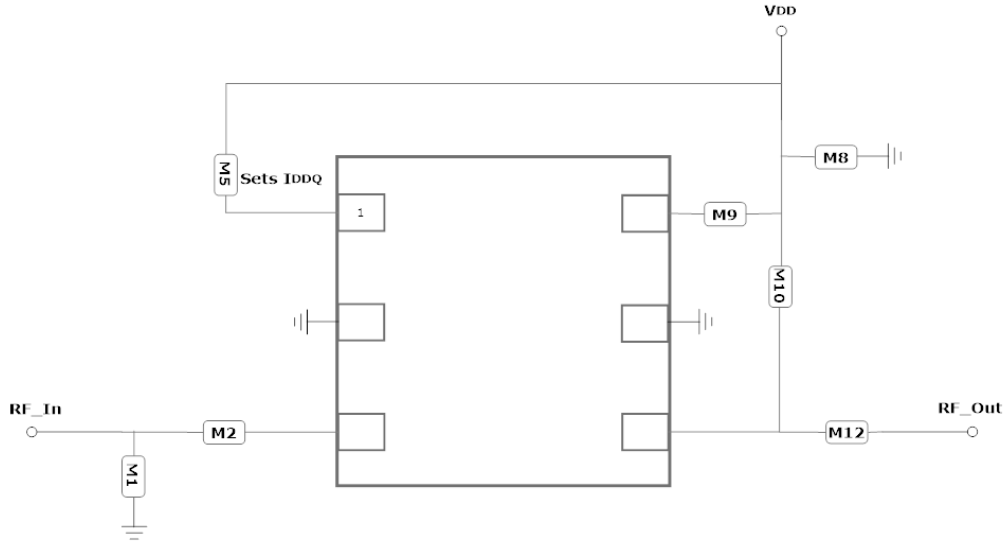

GRF2133 Application Schematic (700–2700 MHz)

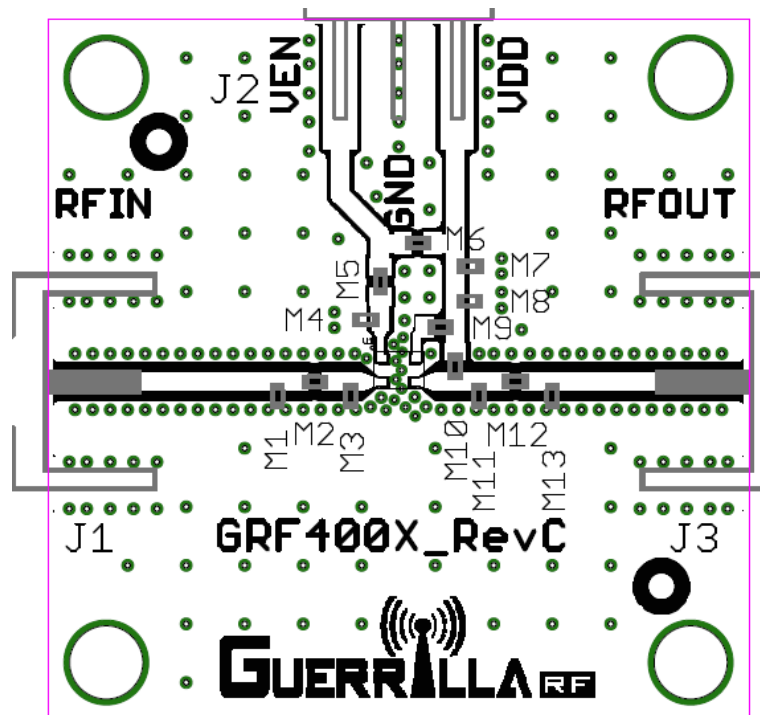

GRF2133 Evaluation Board Assembly Drawing



Released

GRF2133

Ultra-High Gain LNA
Tuning Range: 0.1 to 2.7 GHz

GRF2133 Evaluation Board S-Params and Stability Mu Factor: (5.0V/60mA)

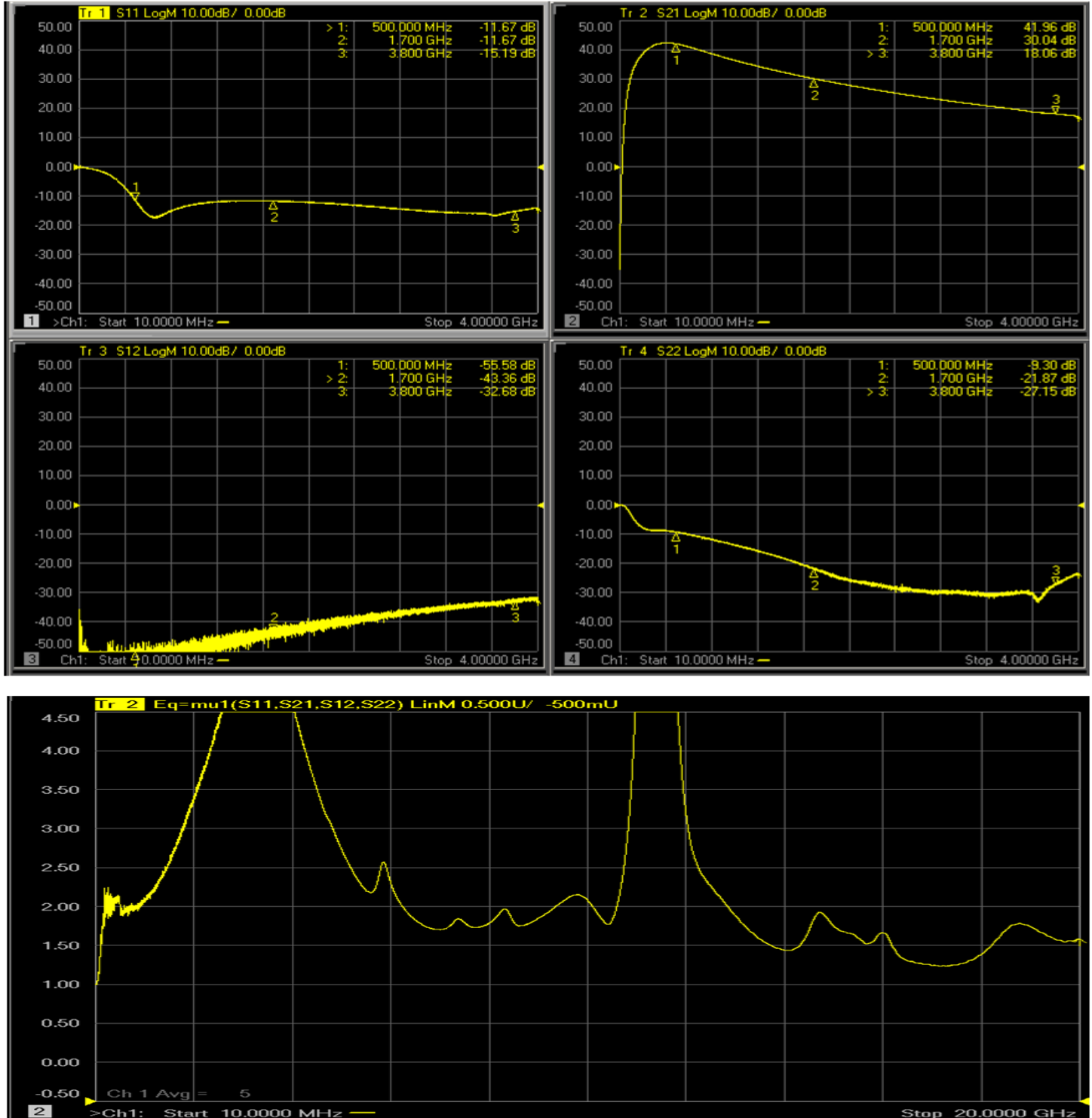

Note: Mu factor ≥ 1.0 implies unconditional stability.

GRF2133 Evaluation Board BOM: (0.7 to 2.7 GHz)

Component	Type	Manufacturer	Family	Value	Package Size	Substitution
M1	Inductor	Murata	LQP/LQG	18 nH	0402	ok
M2	Capacitor	Murata	GJM	33 pF	0402	ok
M5	Resistor	Various	5%	Sets Iddq	0402	ok
M8	Capacitor	Murata	GRM	0.1 uF	0402	ok
M9	Resistor	Various	5%	75 ohms	0402	ok
M10	Inductor	Murata	LQP/LQG	33 nH	0402	ok
M12	Capacitor	Murata	GJM	33 pF	0402	ok

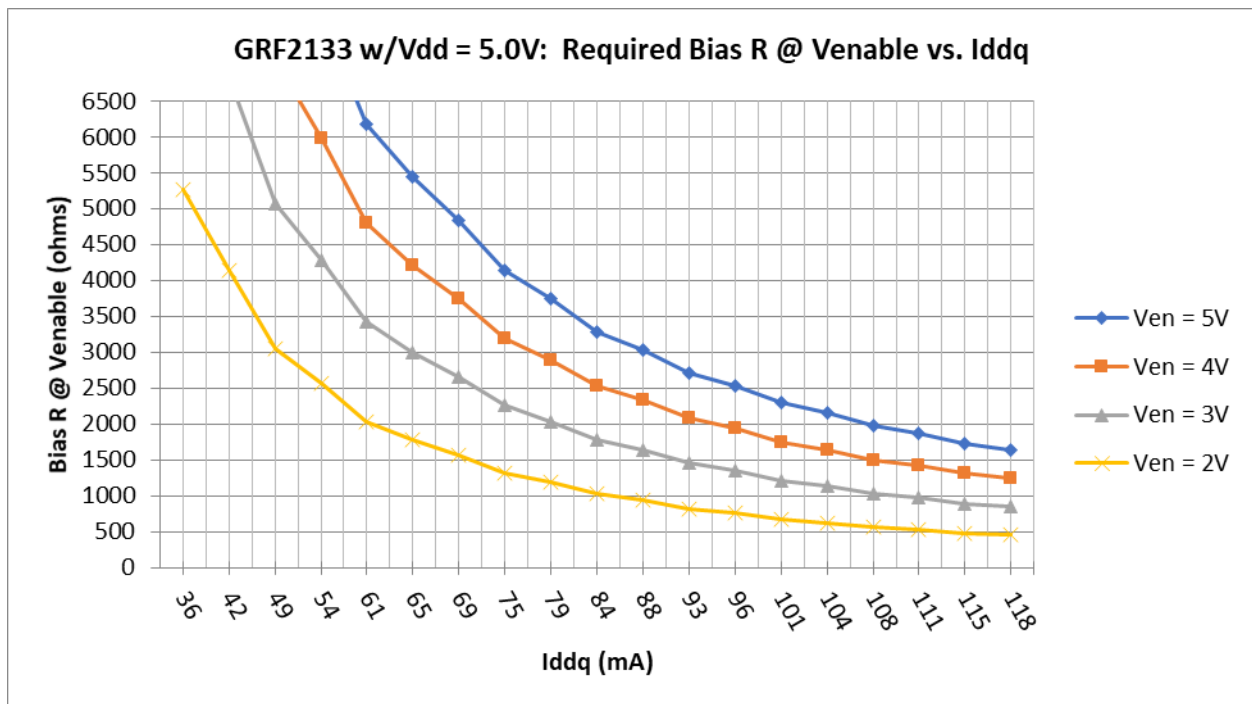

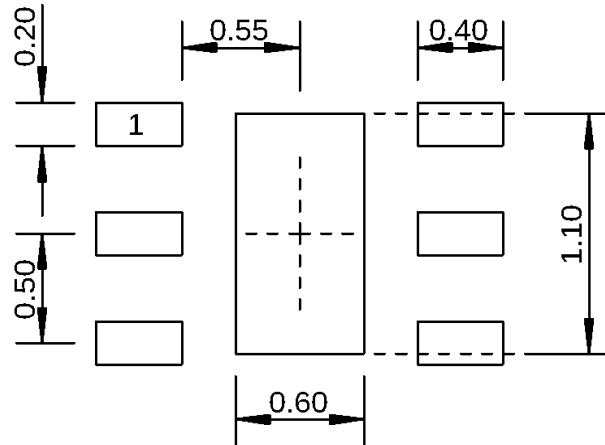

Dimensions in millimeters

1.5 mm DFN-6 Suggested PCB Footprint (Top View)

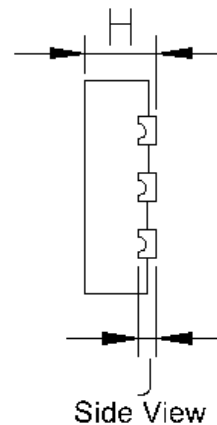
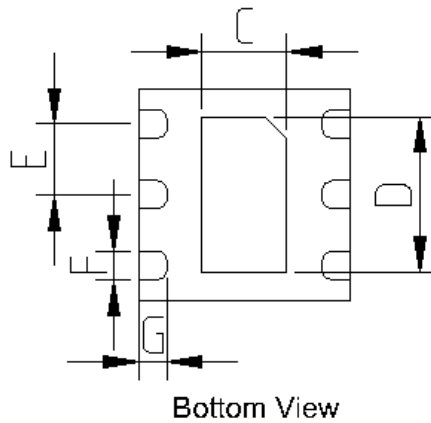
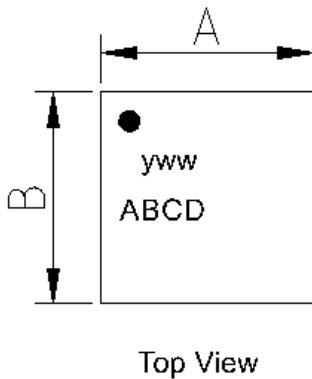

Dimensions (MM)	
A	1.5 +/- 0.050
B	1.5 +/- 0.050
C	.6 +/- 0.050
D	1.1 +/- 0.050
E	.5 Bsc
F	.2 +/- 0.050
G	.2 +/- 0.050
H	.45 +/- 0.050
J	.12 Ref.

1.5 mm DFN-6 Package Dimensions



Released

GRF2133

Ultra-High Gain LNA
Tuning Range: 0.1 to 2.7 GHz

Data Sheet Release Status:	Notes
Advance	S-parameter and NF data based on EM simulations for the fully packaged device using foundry supplied transistor s-parameters. Linearity estimates based on device size, bias condition and experience with related devices.
Preliminary	All data based on evaluation board measurements in the Guerrilla RF Applications Lab.
Released	All data based on device qualification data. Typically, this data is nearly identical to the data found in the preliminary version. Max and min values for key RF parameters are included.

Information in this datasheet is specific to the Guerrilla RF, Inc. ("Guerrilla RF") product identified.

This datasheet, including the information contained in it, is provided by Guerrilla RF as a service to its customers and may be used for informational purposes only by the customer. Guerrilla RF assumes no responsibility for errors or omissions on this datasheet or the information contained herein. Information provided is believed to be accurate and reliable, however, no responsibility is assumed by Guerrilla RF for its use, nor for any infringement of patents, or other rights of third parties, resulting from its use. Guerrilla RF assumes no liability for any datasheet, datasheet information, materials, products, product information, or other information provided hereunder, including the sale, distribution, reproduction or use of Guerrilla RF products, information or materials.

No license, whether express, implied, by estoppel, by implication or otherwise is granted by this datasheet for any intellectual property of Guerrilla RF, or any third party, including without limitation, patents, patent rights, copyrights, trademarks and trade secrets. All rights are reserved by Guerrilla RF.

All information herein, products, product information, datasheets, and datasheet information are subject to change and availability without notice. Guerrilla RF reserves the right to change component circuitry, recommended application circuitry and specifications at any time without prior notice. Guerrilla RF may further change its datasheet, product information, documentation, products, services, specifications or product descriptions at any time, without notice. Guerrilla RF makes no commitment to update any materials or information and shall have no responsibility whatsoever for conflicts, incompatibilities, or other difficulties arising from any future changes.

GUERRILLA RF INFORMATION, PRODUCTS, PRODUCT INFORMATION, DATASHEETS AND DATASHEET INFORMATION ARE PROVIDED "AS IS" AND WITHOUT WARRANTY OF ANY KIND, WHETHER EXPRESS, IMPLIED, STATUTORY, OR OTHERWISE, INCLUDING FITNESS FOR A PARTICULAR PURPOSE OR USE, MERCHANTABILITY, PERFORMANCE, QUALITY OR NON-INFRINGEMENT OF ANY INTELLECTUAL PROPERTY RIGHT; ALL SUCH WARRANTIES ARE HEREBY EXPRESSLY DISCLAIMED. GUERRILLA RF DOES NOT WARRANT THE ACCURACY OR COMPLETENESS OF THE INFORMATION, TEXT, GRAPHICS OR OTHER ITEMS CONTAINED WITHIN THESE MATERIALS. GUERRILLA RF SHALL NOT BE LIABLE FOR ANY DAMAGES, INCLUDING BUT NOT LIMITED TO ANY SPECIAL, INDIRECT, INCIDENTAL, STATUTORY, OR CONSEQUENTIAL DAMAGES, INCLUDING WITHOUT LIMITATION, LOST REVENUES OR LOST PROFITS THAT MAY RESULT FROM THE USE OF THE MATERIALS OR INFORMATION, WHETHER OR NOT THE RECIPIENT OF MATERIALS HAS BEEN ADVISED OF THE POSSIBILITY OF SUCH DAMAGE.

Customers are solely responsible for their use of Guerrilla RF products in the Customer's products and applications or in ways which deviate from Guerrilla RF's published specifications, either intentionally or as a result of design defects, errors, or operation of products outside of published parameters or design specifications. Customers should include design and operating safeguards to minimize these and other risks. Guerrilla RF assumes no liability or responsibility for applications assistance, customer product design, or damage to any equipment resulting from the use of Guerrilla RF products outside of stated published specifications or parameters.

X-ON Electronics

Largest Supplier of Electrical and Electronic Components

Click to view similar products for [RF Development Tools](#) category:

Click to view products by [Guerrilla RF](#) manufacturer:

Other Similar products are found below :

[MAAM-011117](#) [MAAP-015036-DIEEV2](#) [EV1HMC1113LP5](#) [EV1HMC6146BLC5A](#) [EV1HMC637ALP5](#) [EVAL-ADG919EBZ](#) [ADL5363-EVALZ](#) [LMV228SDEVAL](#) [SKYA21001-EVB](#) [SMP1331-085-EVB](#) [EV1HMC618ALP3](#) [EVAL01-HMC1041LC4](#) [MAAL-011111-000SMB](#)
[MAAM-009633-001SMB](#) [MASW-000936-001SMB](#) [107712-HMC369LP3](#) [107780-HMC322ALP4](#) [SP000416870](#) [EV1HMC470ALP3](#)
[EV1HMC520ALC4](#) [EV1HMC244AG16](#) [MAX2614EVKIT#](#) [124694-HMC742ALP5](#) [SC20ASATEA-8GB-STD](#) [MAX2837EVKIT+](#)
[MAX2612EVKIT#](#) [MAX2692EVKIT#](#) [EV1HMC629ALP4E](#) [SKY12343-364LF-EVB](#) [108703-HMC452QS16G](#) [EV1HMC863ALC4](#)
[EV1HMC427ALP3E](#) [119197-HMC658LP2](#) [EV1HMC647ALP6](#) [ADL5725-EVALZ](#) [106815-HMC441LM1](#) [EV1HMC1018ALP4](#)
[UXN14M9PE](#) [MAX2016EVKIT](#) [EV1HMC939ALP4](#) [MAX2410EVKIT](#) [MAX2204EVKIT+](#) [EV1HMC8073LP3D](#) [SIMSA868-DKL](#)
[SIMSA868C-DKL](#) [SKY65806-636EK1](#) [SKY68020-11EK1](#) [SKY67159-396EK1](#) [SKY66181-11-EK1](#) [SKY65804-696EK1](#)