



## Product Description

GRF2710 is a high gain, low noise, linear amplifier designed for high performance 8.0 to 12.0 GHz X-band applications. Over this frequency range, it exhibits excellent gain and compression point.

The device is operated from a single positive supply of 3.0 to 5.0 V with a typical bias condition of 5.0 V and 25 mA. The application schematic requires a minimal number of matching components to cover the 8.0 to 12.0 GHz band.

Consult with the GRF applications engineering team for custom tuning/evaluation board data and device s-parameters are located on the website landing page.

## Features

Reference: 5.0V/25mA/10.0 GHz

- Gain: 13.2 dB
- EVB NF: 1.9 dB
- OP1dB: 12.8 dBm
- OIP3: 24.0 dBm
- Flexible Bias Voltage and Current
- Process: GaAs pHEMT

## Applications

- X-Band LNA
- Microwave Oscillator
- LO Buffer
- RFID
- Motion Detectors
- Microwave Backhaul

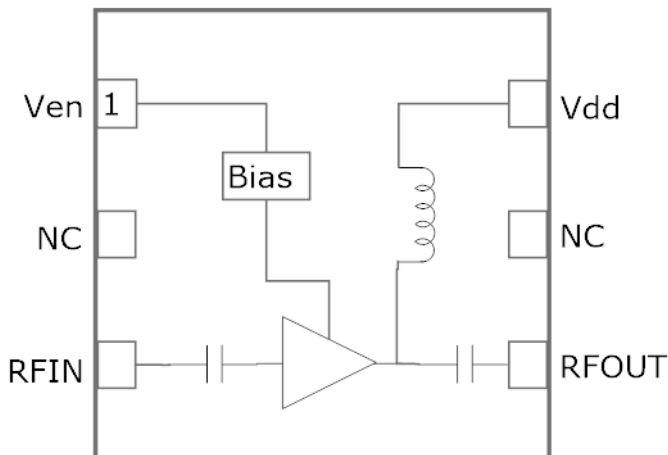

1.5 x 1.5 mm DFN-6

## Absolute Ratings:

Parameter	Symbol	Min.	Max.	Unit
Supply Voltage	V <sub>DD</sub>	0	6.0	V
RF Input Power: (Load VSWR < 2:1; V <sub>D</sub> : 5.0 volts)	P <sub>IN MAX</sub>		15	dBm
Operating Temperature (Package Heat Sink)	T <sub>AMB</sub>	-40	105	°C
Maximum Channel Temperature (MTTF > 10 <sup>6</sup> Hours)	T <sub>MAX</sub>		170	°C
Maximum Dissipated Power	P <sub>DISS MAX</sub>		300	mW
<b>Electrostatic Discharge:</b>				
Charged Device Model:	CDM	1500		V
Human Body Model:	HBM	250		V
<b>Storage:</b>				
Storage Temperature	T <sub>STG</sub>	-65	150	°C
Moisture Sensitivity Level	MSL		1	--

**Caution!** ESD Sensitive Device



Exceeding Absolute Maximum Rating conditions may cause permanent damage to the device.

**Note:** For manufacturing information, see the [Guerrilla-RF.com](http://Guerrilla-RF.com) website for the following document located on the GRF2710 landing page: Manufacturing Note—MN-001 Product Tape and Reel, Solderability and Package Outline Specification.

[Link to manufacturing note:](#)

## Pin Out (Top View)

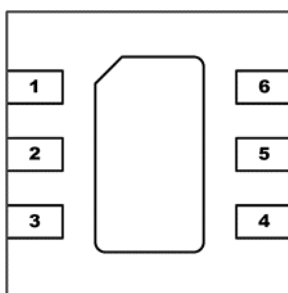

## Pin Assignments:

Pin	Name	Description	Note
1	<b>V<sub>ENABLE</sub></b>	LNA Enable Input	V <sub>ENABLE</sub> and series resistor set I <sub>DDQ</sub> . V <sub>ENABLE</sub> < =0.2 volts disables device. On-die pull-down resistor will turn the part off if this node is allowed to float.
2	<b>NC</b>	No Connect or Ground	No internal connection to die
3	<b>RF_In</b>	LNA RF input	Internally pre-matched to 50 Ω. These ports may be DC connected to ground externally but no DC > 0.2 volts should be applied to these ports.
4	<b>RF_Out</b>	LNA RF output	
5	<b>NC</b>	No Connect or Ground	No internal connection to die
6	<b>V<sub>DD</sub></b>	Supply Voltage for the LNA	Requires bypass capacitance as close as possible to pin on PCB
<b>PKG BASE</b>	<b>GND</b>	Ground	Provides DC and RF ground for LNA, as well as thermal heat sink. Recommend multiple 8 mil vias beneath the package for optimal RF and thermal performance. Refer to evaluation board top layer graphic on schematic page.

## V<sub>ENABLE</sub> Truth Table:

V <sub>DD</sub>	V <sub>ENABLE</sub>	Mode
High	>=1.8 V	LNA On
High	<0.1 V	LNA Off



Released

# GRF2710

High Gain, X-Band LNA  
Tuning Range: 8.0 to 12.0 GHz

## Nominal Operating Parameters:

Parameter	Symbol	Specification			Unit	Condition
		Min.	Typ.	Max.		
<b>High Gain Mode</b>						$V_{DD} = 5.0V, T_A = 25^\circ C$
Test Frequency	$F_{TEST}$		10.0		GHz	
Gain	$S_{21}$	11.7	13.2		dB	
Evaluation Board Noise Figure	NF		1.9	2.3	dB	
Output 3rd Order Intercept Point	OIP3		24.0		dBm	
Output 1dB Compression	OP1dB	10.8	12.8		dBm	
Supply Current (Quiescent)	$I_{DD}$		25.0		mA	
Switching Rise Time	$T_{RISE}$		300		ns	
Switching Fall Time	$T_{FALL}$		100		ns	
Enable Current	$I_{ENABLE}$		1.5		mA	
<b>Disabled Mode</b>						$V_{DD} = 5.0V, V_{ENABLE} = 0.0V$
Supply Current (Leakage)	$I_{DD}$		160		$\mu A$	
<b>Thermal Data</b>						
Thermal Resistance (Infra-Red Scan)	$\Theta_{jc}$		141		$^\circ C/W$	
Channel Temperature @ +85 C reference (Package heat sink)	$T_{CHANNEL}$		103 (See note)		$^\circ C$	$V_{DD}: 5.0V; I_{DDQ}: 25\text{ mA}; \text{No RF}$ $P_{DISS}: 125\text{ mW}$

Note: MTF >10<sup>6</sup> hours for  $T_{CHANNEL} < = 170$  degrees C.



Released

# GRF2710

High Gain, X-Band LNA  
Tuning Range: 8.0 to 12.0 GHz

## GRF2710 Evaluation Board Data:

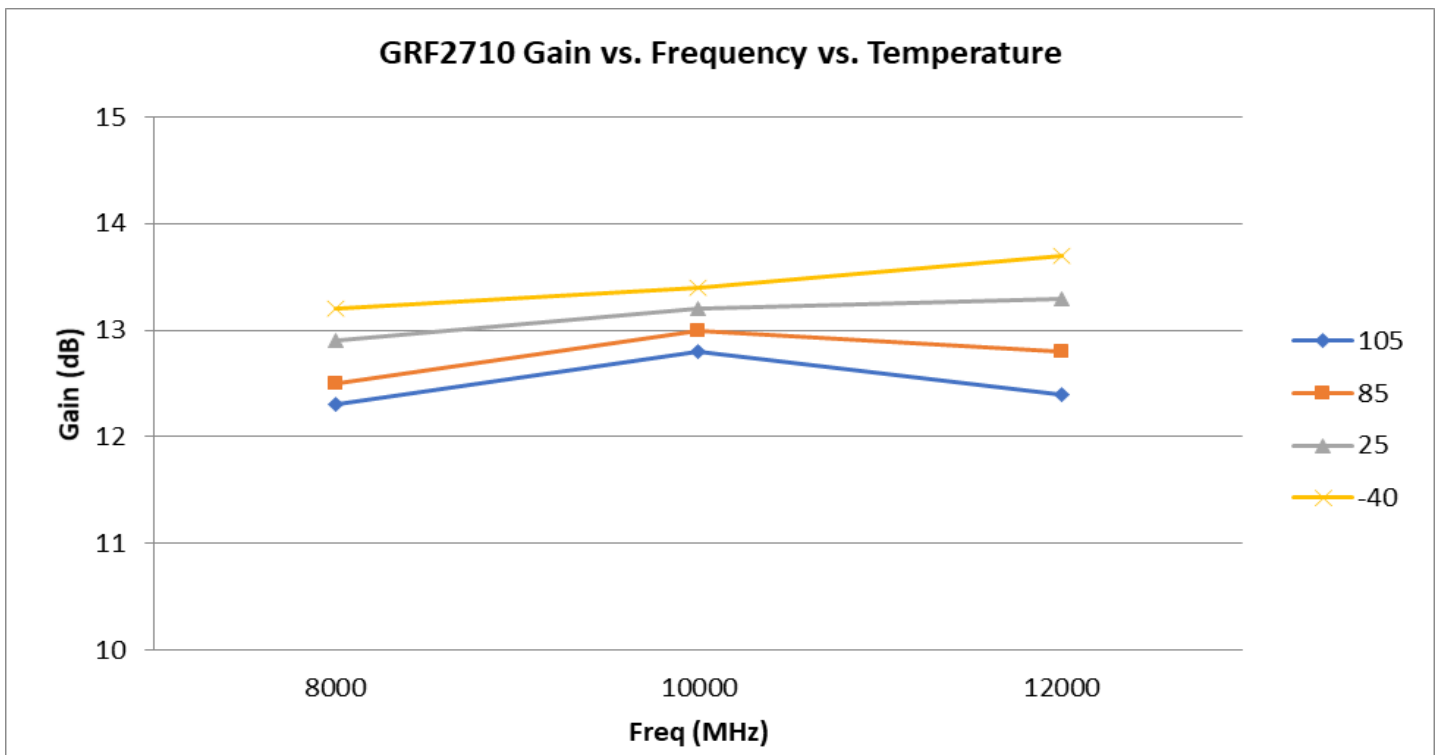
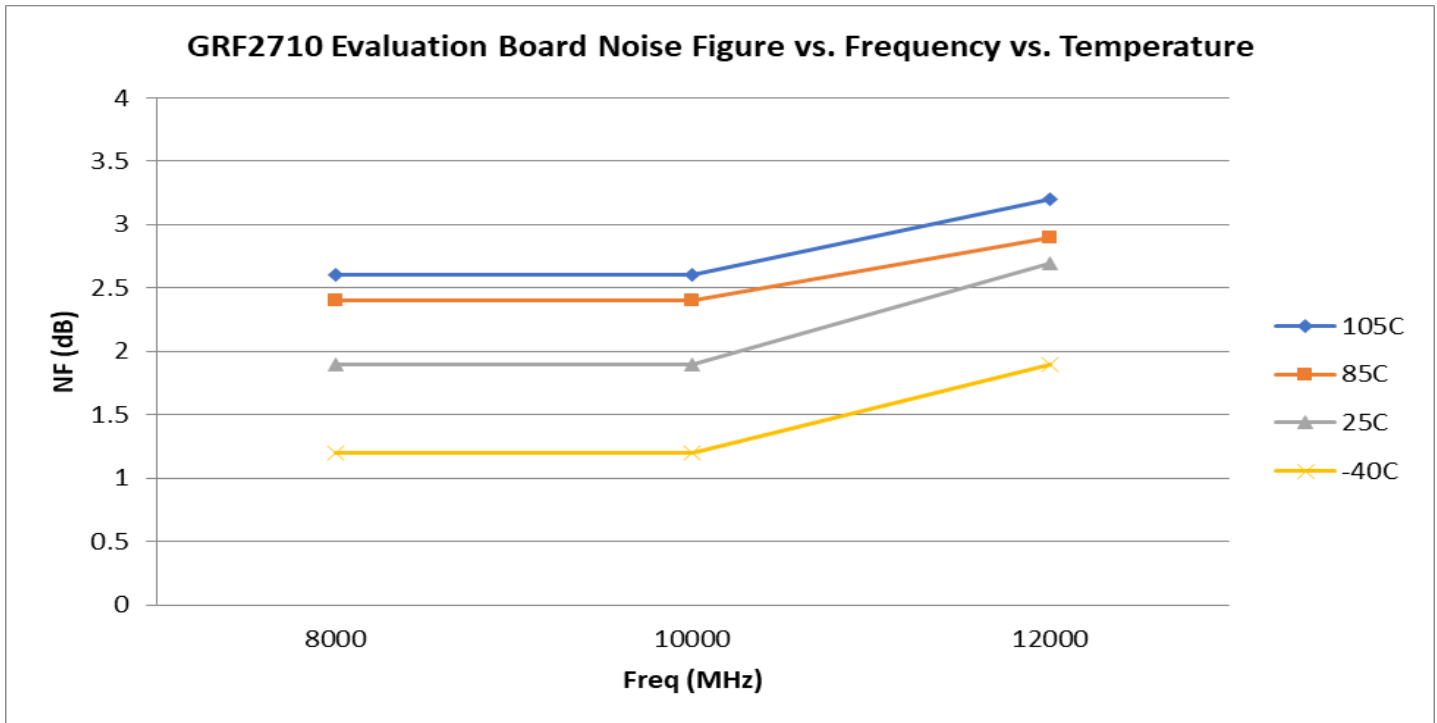



Released

# GRF2710

High Gain, X-Band LNA  
Tuning Range: 8.0 to 12.0 GHz

## GRF2710 Evaluation Board Data:

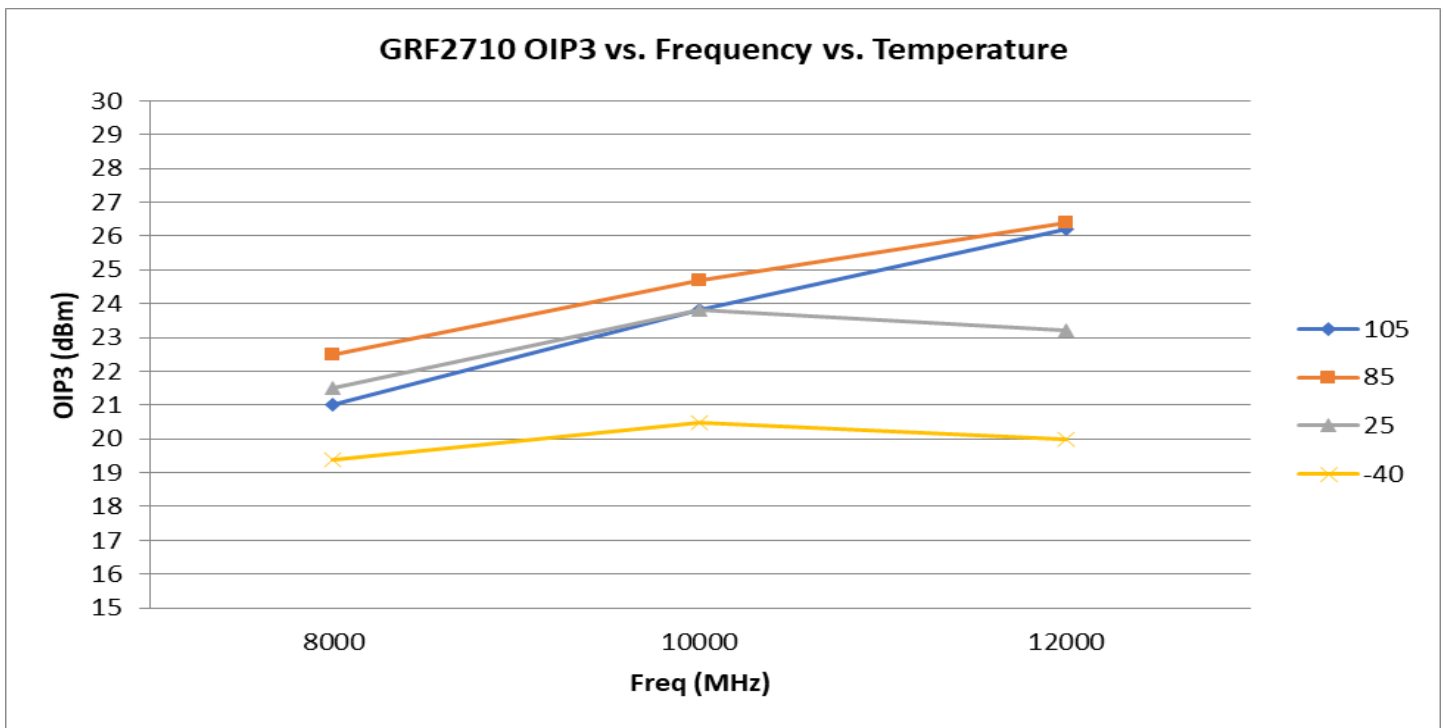
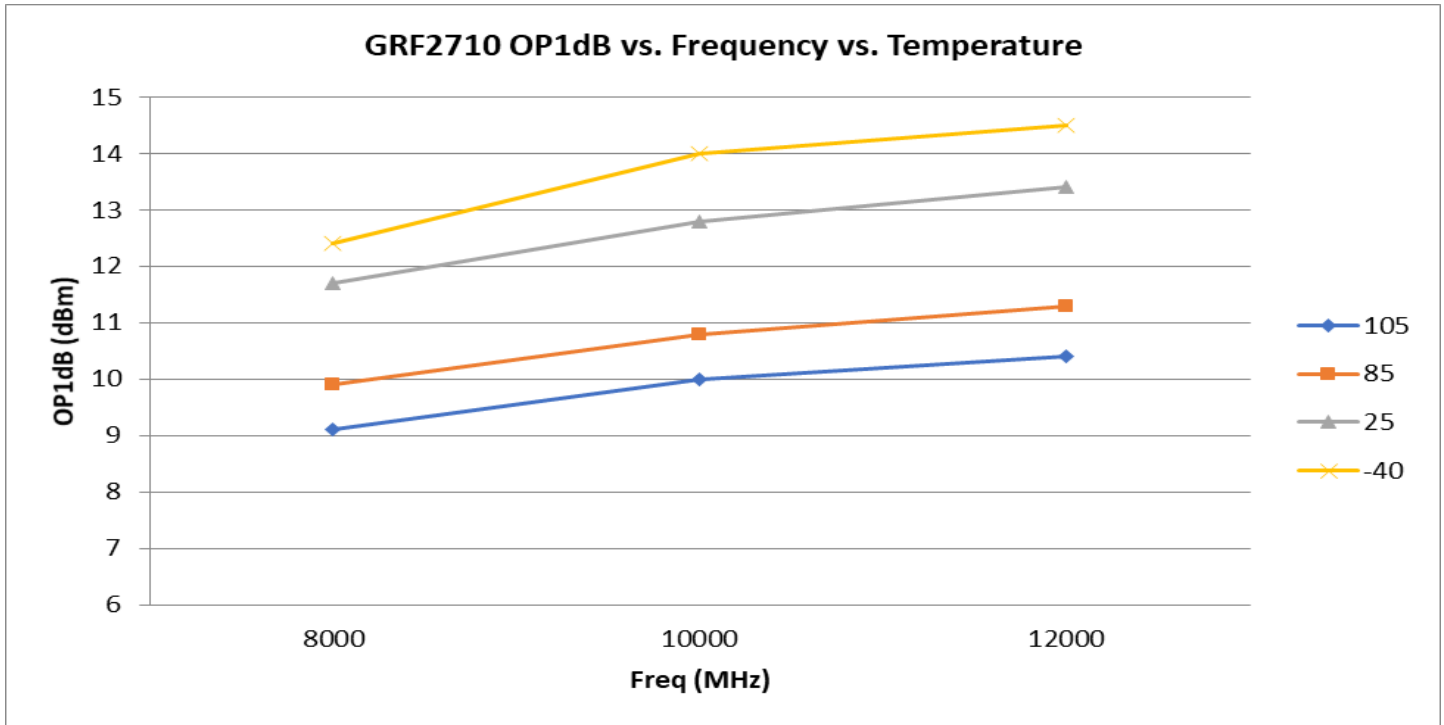



Released

# GRF2710

High Gain, X-Band LNA  
Tuning Range: 8.0 to 12.0 GHz

## GRF2710 Evaluation Board S-Parameters and Stability Mu Factor:

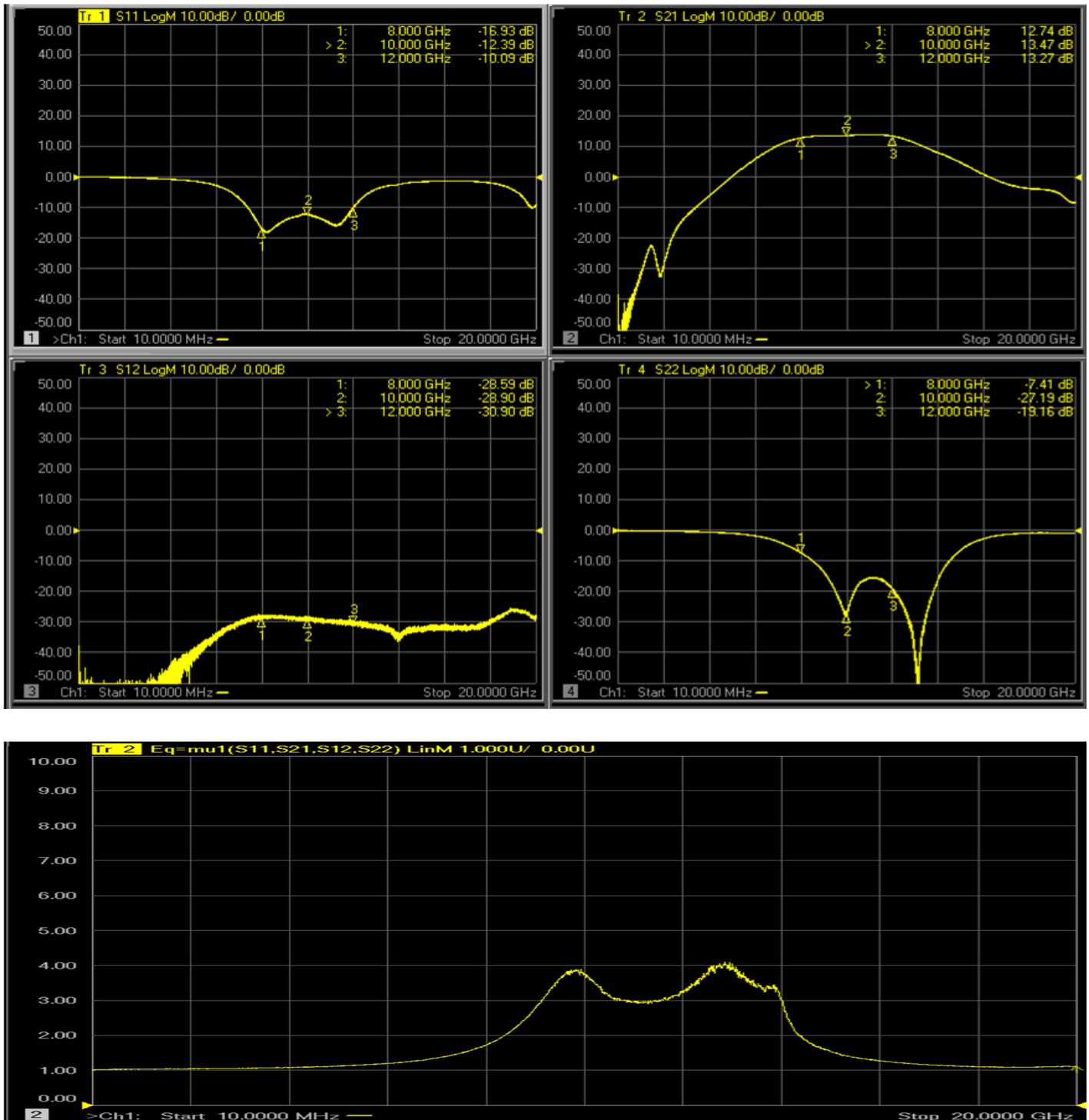

Note:  $\mu \geq 1.0$  implies unconditional stability

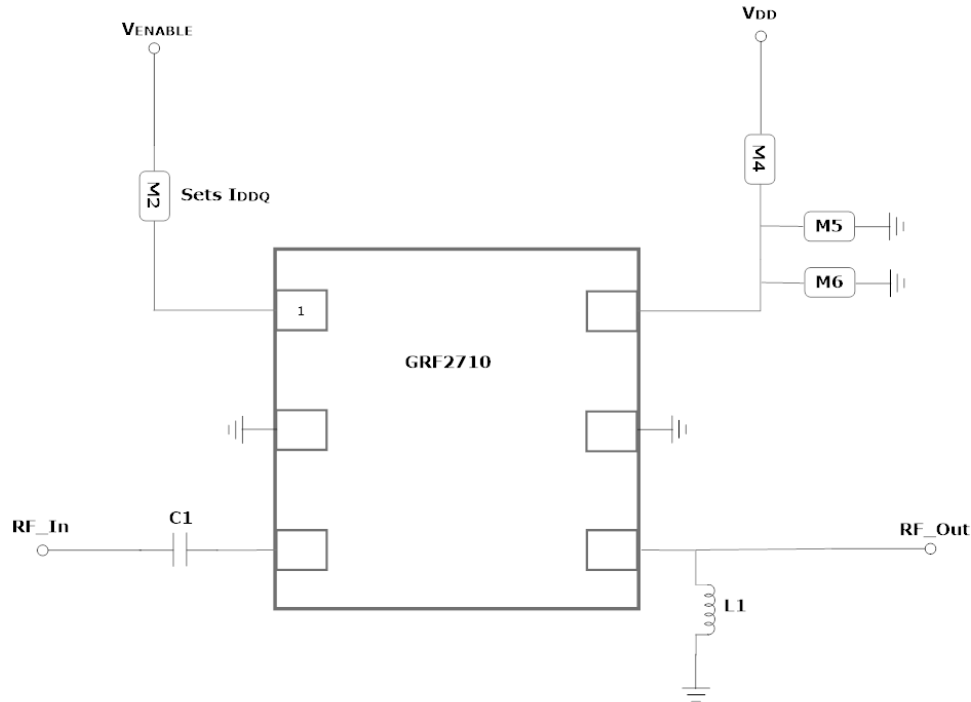

GRF2710 Standard Application Schematic

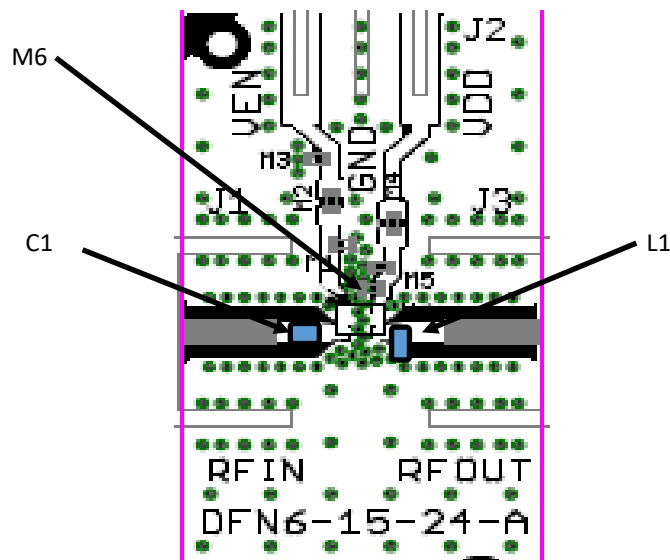

GRF2710 Evaluation Board Assembly Diagram





Released

# GRF2710

High Gain, X-Band LNA  
Tuning Range: 8.0 to 12.0 GHz

## GRF2710 Standard Evaluation Board BOM; 8 to 12 GHz

Component	Type	Manufacturer	Family	Value	Package Size	Substitution
C1 (Close to pin 3)	Capacitor	Murata	GJM	0.7 pF	0402	ok
M2 (See curves)	Resistor	Various	5%	Sets Iddq	0402	ok
M4	0 Ohm Jumper	—	—	—	0402	ok
M5	Capacitor	Murata	GRM	0.1 uF	0402	ok
M6 (Close to pin 6)	Capacitor	Murata	GJM	10 pF	0402	ok
L1 (Close to pin 4)	Inductor	Murata	LQP	1.8 nH	0402	ok
Evaluation Board	DFN6-15-24-A					

## GRF2710 Bias Resistor Selection Curves

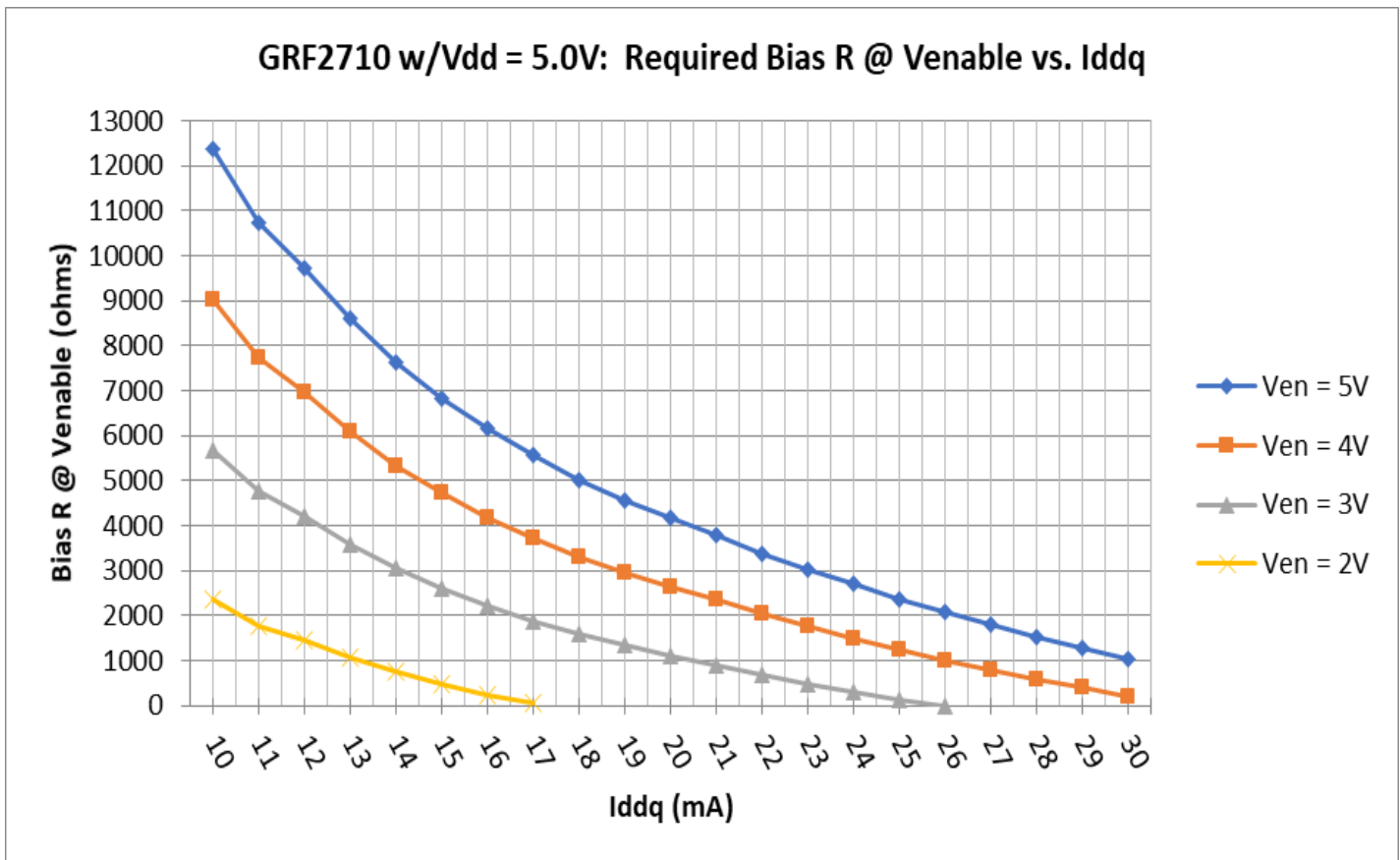

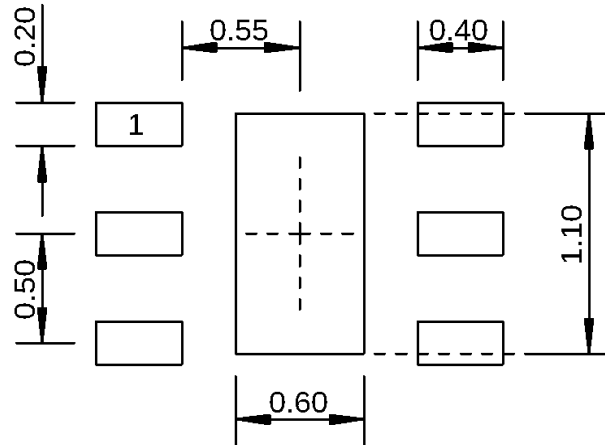

Dimensions in millimeters

### 1.5 mm DFN-6 Suggested PCB Footprint (Top View)

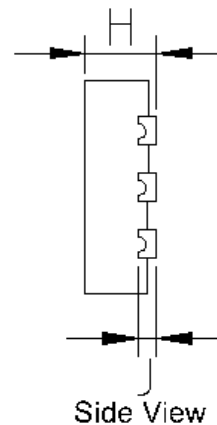
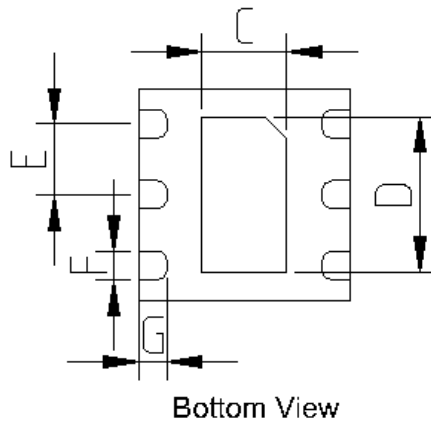
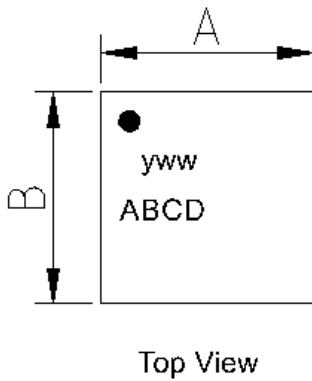

Dimensions (MM)	
A	1.5 +/- 0.050
B	1.5 +/- 0.050
C	.6 +/- 0.050
D	1.1 +/- 0.050
E	.5 Bsc
F	.2 +/- 0.050
G	.2 +/- 0.050
H	.45 +/- 0.050
J	.12 Ref.

### 1.5 mm DFN-6 Package Dimensions

### Tape and Reel Information:

Guerrilla RF's Tape and Reel specification complies with the Electronics Industries Association (EIA) standards for 'Embossed Carrier Tape of Surface Mount Components for Automatic Handling'. Reference EIA-481. See the table on the following page for Tape and Reel specifications along with units per reel.

Devices are loaded with pins down into the carrier pocket with protective cover tape, wound into a plastic reel. Each reel will be packaged in a cardboard box. There will be product labels on the reel, the protective ESD bag and the outside surface of the box.

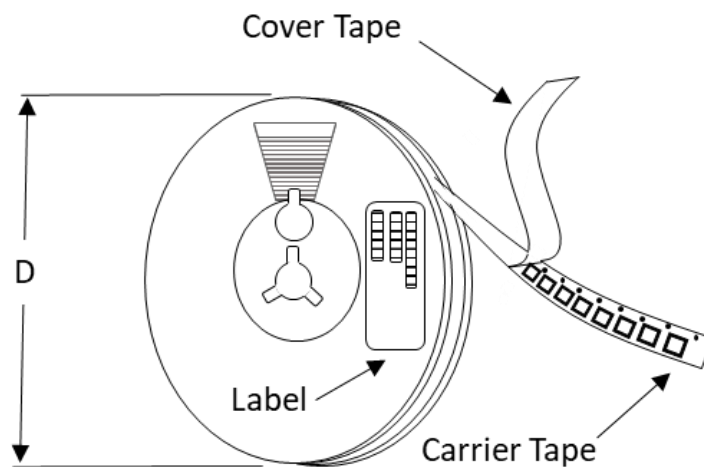

Tape and Reel Packaging with Reel Diameter Noted (D)

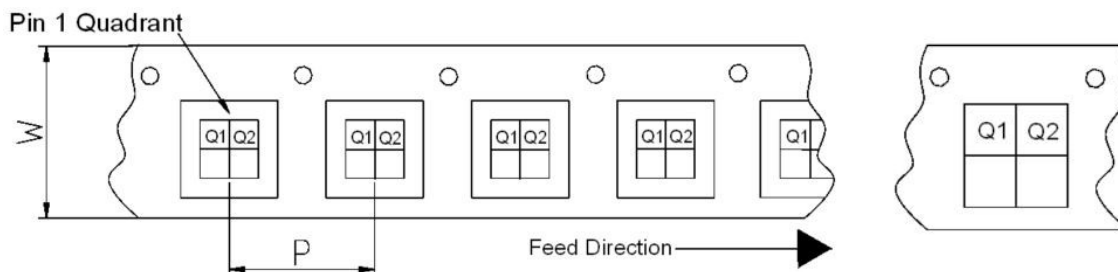

Carrier Tape Width (W), Pitch (P), Feed Direction and Pin 1 Quadrant Information



Released

# GRF2710

High Gain, X-Band LNA  
Tuning Range: 8.0 to 12.0 GHz

Tape and Reel Specification and Device Package Information Table

Package				Carrier Tape			Reel	
Type	Dimensions (mm)	Leads	Weight (mg)	Width (W) (mm)	Pocket Pitch (P) (mm)	Pin 1 Quadrant	Diameter (D) (inches)	Units per Reel
QFN	2.0 x 2.0 x 0.50	12	7	8	4	Q1	7	2500
QFN	3.0 x 3.0 x 0.85	16	24	12	8	Q1	7	1500
DFN	1.5 x 1.5 x 0.45	6	4	8	4	Q1	7	2500
DFN	2.0 x 2.0 x 0.75	8	12	8	4	Q1	7	2500
LFM	3.5 x 3.5 x 0.75	See note	TBD	12	8	Q2	7	1500
LFM	4.0 x 4.0 x 0.75	See note	TBD	12	8	Q2	7	1500

Note: Lead count may vary. Reference applicable product data sheet



Released

# GRF2710

High Gain, X-Band LNA  
Tuning Range: 8.0 to 12.0 GHz

Data Sheet Release Status:	Notes
Advance	S-parameter and NF data based on EM simulations for the fully packaged device using foundry supplied transistor s-parameters. Linearity estimates based on device size, bias condition and experience with related devices.
Preliminary	All data based on evaluation board measurements in the Guerrilla RF Applications Lab.
Released	All data based on device qualification data. Typically, this data is nearly identical to the data found in the preliminary version. Max and min values for key RF parameters are included.

Information in this datasheet is specific to the Guerrilla RF, Inc. ("Guerrilla RF") product identified.

This datasheet, including the information contained in it, is provided by Guerrilla RF as a service to its customers and may be used for informational purposes only by the customer. Guerrilla RF assumes no responsibility for errors or omissions on this datasheet or the information contained herein. Information provided is believed to be accurate and reliable, however, no responsibility is assumed by Guerrilla RF for its use, nor for any infringement of patents, or other rights of third parties, resulting from its use. Guerrilla RF assumes no liability for any datasheet, datasheet information, materials, products, product information, or other information provided hereunder, including the sale, distribution, reproduction or use of Guerrilla RF products, information or materials.

No license, whether express, implied, by estoppel, by implication or otherwise is granted by this datasheet for any intellectual property of Guerrilla RF, or any third party, including without limitation, patents, patent rights, copyrights, trademarks and trade secrets. All rights are reserved by Guerrilla RF.

All information herein, products, product information, datasheets, and datasheet information are subject to change and availability without notice. Guerrilla RF reserves the right to change component circuitry, recommended application circuitry and specifications at any time without prior notice. Guerrilla RF may further change its datasheet, product information, documentation, products, services, specifications or product descriptions at any time, without notice. Guerrilla RF makes no commitment to update any materials or information and shall have no responsibility whatsoever for conflicts, incompatibilities, or other difficulties arising from any future changes.

GUERRILLA RF INFORMATION, PRODUCTS, PRODUCT INFORMATION, DATASHEETS AND DATASHEET INFORMATION ARE PROVIDED "AS IS" AND WITHOUT WARRANTY OF ANY KIND, WHETHER EXPRESS, IMPLIED, STATUTORY, OR OTHERWISE, INCLUDING FITNESS FOR A PARTICULAR PURPOSE OR USE, MERCHANTABILITY, PERFORMANCE, QUALITY OR NON-INFRINGEMENT OF ANY INTELLECTUAL PROPERTY RIGHT; ALL SUCH WARRANTIES ARE HEREBY EXPRESSLY DISCLAIMED. GUERRILLA RF DOES NOT WARRANT THE ACCURACY OR COMPLETENESS OF THE INFORMATION, TEXT, GRAPHICS OR OTHER ITEMS CONTAINED WITHIN THESE MATERIALS. GUERRILLA RF SHALL NOT BE LIABLE FOR ANY DAMAGES, INCLUDING BUT NOT LIMITED TO ANY SPECIAL, INDIRECT, INCIDENTAL, STATUTORY, OR CONSEQUENTIAL DAMAGES, INCLUDING WITHOUT LIMITATION, LOST REVENUES OR LOST PROFITS THAT MAY RESULT FROM THE USE OF THE MATERIALS OR INFORMATION, WHETHER OR NOT THE RECIPIENT OF MATERIALS HAS BEEN ADVISED OF THE POSSIBILITY OF SUCH DAMAGE.

Customers are solely responsible for their use of Guerrilla RF products in the Customer's products and applications or in ways which deviate from Guerrilla RF's published specifications, either intentionally or as a result of design defects, errors, or operation of products outside of published parameters or design specifications. Customers should include design and operating safeguards to minimize these and other risks. Guerrilla RF assumes no liability or responsibility for applications assistance, customer product design, or damage to any equipment resulting from the use of Guerrilla RF products outside of stated published specifications or parameters.

Guerrilla RF Proprietary Information. Guerrilla RF™ and the composite logo of Guerrilla RF™ are trademarks of Guerrilla RF, Inc. ©2014 Guerrilla RF, Inc. All rights reserved.

## X-ON Electronics

Largest Supplier of Electrical and Electronic Components

*Click to view similar products for [RF Amplifier](#) category:*

*Click to view products by [Guerrilla RF](#) manufacturer:*

Other Similar products are found below :

[A82-1](#) [BGA622H6820XTSA1](#) [BGA 728L7 E6327](#) [BGB719N7ESDE6327XTMA1](#) [HMC397-SX](#) [HMC405](#) [HMC561-SX](#) [HMC8120-SX](#)  
[HMC8121-SX](#) [HMC-ALH382-SX](#) [HMC-ALH476-SX](#) [SE2433T-R](#) [SMA3101-TL-E](#) [SMA39](#) [A66-1](#) [A66-3](#) [A67-1](#) [A81-2](#) [LX5535LQ](#)  
[LX5540LL](#) [MAAM02350](#) [HMC3653LP3BETR](#) [HMC549MS8GETR](#) [HMC576-SX](#) [HMC-ALH435-SX](#) [SMA101](#) [SMA32](#) [SMA411](#)  
[SMA531](#) [SST12LP19E-QX6E](#) [WPM0510A](#) [HMC5879LS7TR](#) [HMC1087F10](#) [HMC1086](#) [HMC1016](#) [SMA1212](#) [MAX2689EWS+T](#)  
[MAAMSS0041TR](#) [MAAM37000-A1G](#) [LTC6430AIUF-15#PBF](#) [SMA70-2](#) [SMA4011](#) [A231](#) [HMC-AUH232](#) [LX5511LQ](#) [LX5511LQ-TR](#)  
[HMC7441-SX](#) [HMC-ALH310](#) [XD1001-BD-000V](#) [A4011](#)