



Released

GRF5115

33.0 dBm Power-LNA™
Tuning Range: 0.1 – 2.7 GHz



Product Description

GRF5115 is a high efficiency PA/Driver that delivers an OP1dB of 33 dBm with greater than 55% drain efficiency. It is tunable from 100 MHz up to 2.7 GHz with typical fractional bandwidths of 5 to 10%

The device can be biased with Vdd over a range from 2.7 to 5.0 volts and Iddq can be adjusted for optimal linearity and efficiency.

Consult with the GRF applications engineering team for custom tuning/evaluation board data and device s-parameters.

Features

Reference: 5V/300mA/1.95GHz

- Gain: 14.8 dB
- OP1dB: 33.2 dBm
- Drain Efficiency: 58%
- OIP3: 43.0 dBm
- Eval Board NF: 1.3 dB

- Flexible Bias Voltage and Current
- Process: GaAs pHEMT

Applications

- High Efficiency Power Amplifier
- Multi-stage LNA
- Linear Driver

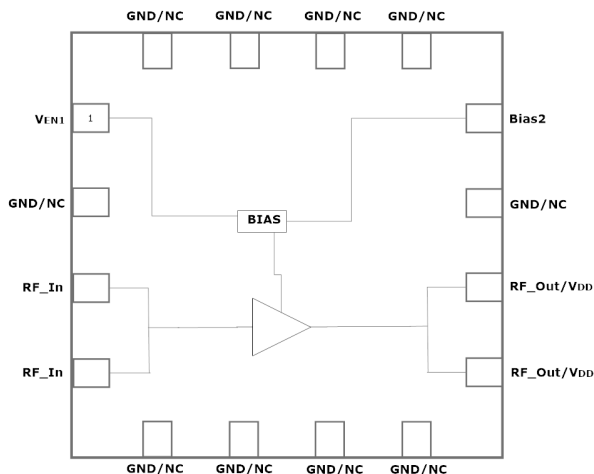

3.0 x 3.0 mm QFN-16



Released

GRF5115

33.0 dBm Power-LNA™
Tuning Range: 0.1 – 2.7 GHz

Absolute Ratings:

Parameter	Symbol	Min.	Max.	Unit
Drain Voltage	V _{DD}		5.5	V
Transient Average RF Input Power: (Load VSWR < 2:1; Duration: <1 hour)	P _{IN MAX}		23.0	dBm
Operating Temperature (Package Heat Sink)	T _{AMB}	-40	85	°C
Maximum Channel Temperature (MTTF > 10 ⁶ Hours)	T _{MAX}		170	°C
Maximum Dissipated Power	P _{DISS MAX}		2.0	W
Electrostatic Discharge:				
Charged Device Model: (TBD)	CDM	1500		V
Human Body Model: (TBD)	HBM	250		V
Storage:				
Storage Temperature	T _{STG}	-65	150	°C
Moisture Sensitivity Level	MSL		1	–



Caution! ESD Sensitive Device



Exceeding Absolute Maximum Rating conditions may cause permanent damage to the device.

Note: For manufacturing information, see the Guerrilla-RF.com website for the following document located on the GRF5115 landing page: **Manufacturing Note—MN-001 Product Tape and Reel, Solderability and Package Outline Specification.**

[Link to manufacturing note](#)

Pin Out (Top View)

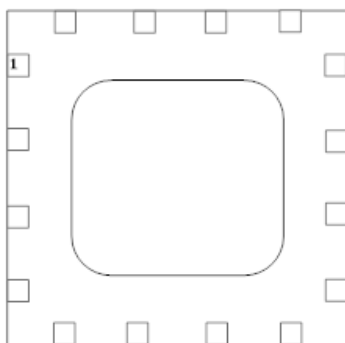

Pin Assignments:

Pin	Name	Description	Note
1	V _{EN1}	Enable Voltage Input	V _{ENABLE} and series resistor set I _{DDQ} . V _{EN1} < =0.2 volts disables device. On-die pull-down resistor will turn the part off if this node is allowed to float.
2	NC	No Connect or Ground	No internal connection to die
3	RF_In	RF Input	Pins 3-4 tied together on system board. R1 to ground is placed to limit self-biasing. The value of R1 also contributes to the device I _{DDQ}
4	RF_In	RF Input	Pins 3-4 tied together on system board. R1 to ground is placed to limit self-biasing. The value of R1 also contributes to the device I _{DDQ}
5	NC	No Connect or Ground	No internal connection to die
6	NC	No Connect or Ground	No internal connection to die
7	NC	No Connect or Ground	No internal connection to die
8	NC	No Connect or Ground	No internal connection to die
9	RF_Out/V _{DD}	PA Output/Bias	Pins 9-10 tied together on system board. Supply V _{DD} here.
10	RF_Out/V _{DD}	PA Output/Bias	Pins 9-10 tied together on system board. Supply V _{DD} here.
11	NC	No Connect or Ground	No internal connection to die
12	Bias2	Bias Circuit Supply	Connect to V _{DD} through external resistor
13	NC	No Connect or Ground	No internal connection to die
14	Bias1	Bias Circuit Ground	Consult application schematic
15	NC	No Connect or Ground	No internal connection to die
16	NC	No Connect or Ground	No internal connection to die
PKG BASE	GND	Ground	Provides DC and RF ground for LNA, as well as thermal heat sink. Recommend multiple 8 mil vias beneath the package for optimal RF and thermal performance. Refer to evaluation board top layer graphic on schematic page.



Released

GRF5115

33.0 dBm Power-LNA™
Tuning Range: 0.1 – 2.7 GHz

Nominal Operating Parameters:

Parameter	Symbol	Specification			Unit	Condition
		Min.	Typ.	Max.		
Target Performance (1.9 to 2.0 GHz Tune)						Bias: 5.0 V and 300 mA unless otherwise noted. (+25C)
Test Frequency	F _{TEST}		1.95		GHz	
Gain	S(2,1)	13.8	14.8	15.8	dB	
Noise Figure (Evaluation Board)	NF		1.3	1.6	dB	
Output 1dB Compression Point	OP1dB	31.5	33.0		dBm	
Drain Efficiency @ OP1dB	η		58.0		%	
Output Third Order Intercept Point	OIP3		43.0		dBm	12.0 dBm P _{OUT} per tone (1949 and 1951 MHz)
Switching Rise Time	T _{RISE}		100		ns	
Switching Fall Time	T _{FALL}		850		ns	
Quiescent Supply Current	I _{DDQ}	200	300	400	mA	V _{DD} = V _{EN1} = 5.0V; M1: 22k ohms; M9: 100k ohms; R1: 15k ohms
Enable Current	I _{ENABLE}		0.5		mA	
Disabled Mode						
Supply Current (Leakage)	I _{DD}		2.0		uA	
Thermal Data						
Thermal Resistance: (IR Scan Method)	Θ _{JC}		40		°C/W	
Channel Temperature @ +85C Reference (package heat sink)	T _{CHANNEL}		145 (See note)		°C	V _{DD} : 5.0 volts; I _{DDQ} : 300 mA P _{DISS} : 1.5 W; No RF

Note: MTTF >10⁶ hours for T_{CHANNEL} <=170 degrees C.



Released

GRF5115

33.0 dBm Power-LNA™
Tuning Range: 0.1 – 2.7 GHz

GRF5115 Evaluation Board Data: (1.9 to 2.0 GHz Tune)

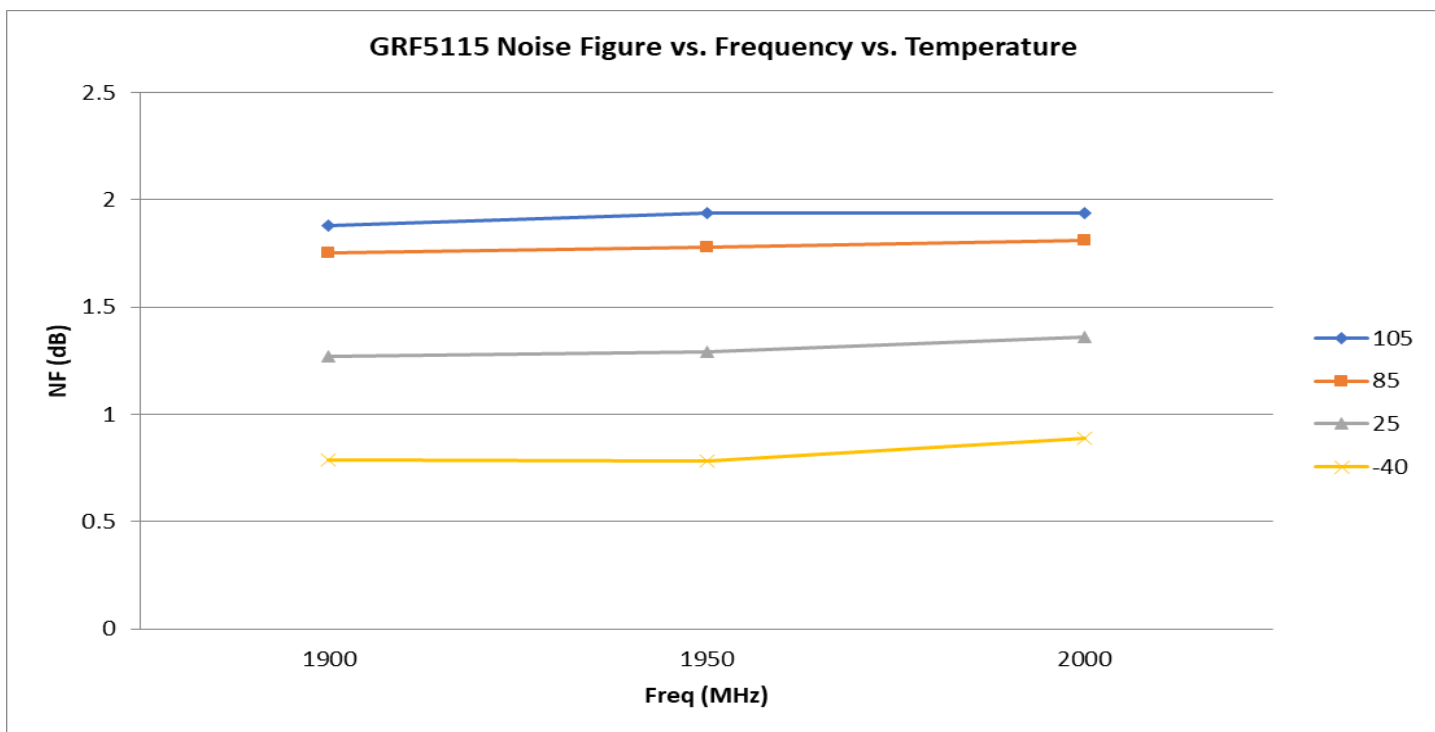
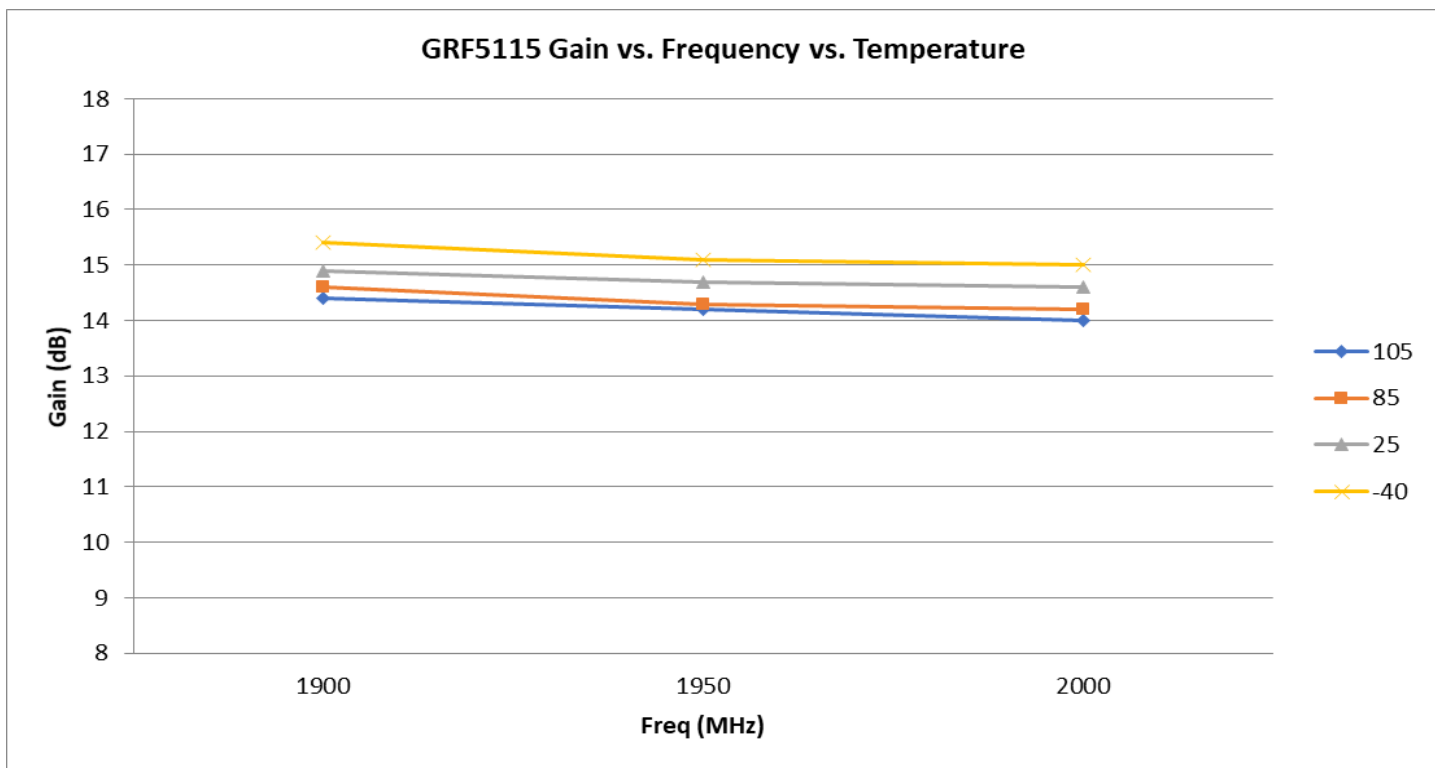



Released

GRF5115

33.0 dBm Power-LNA™
Tuning Range: 0.1 – 2.7 GHz

GRF5115 Evaluation Board Data: (1.9 to 2.0 GHz Tune)

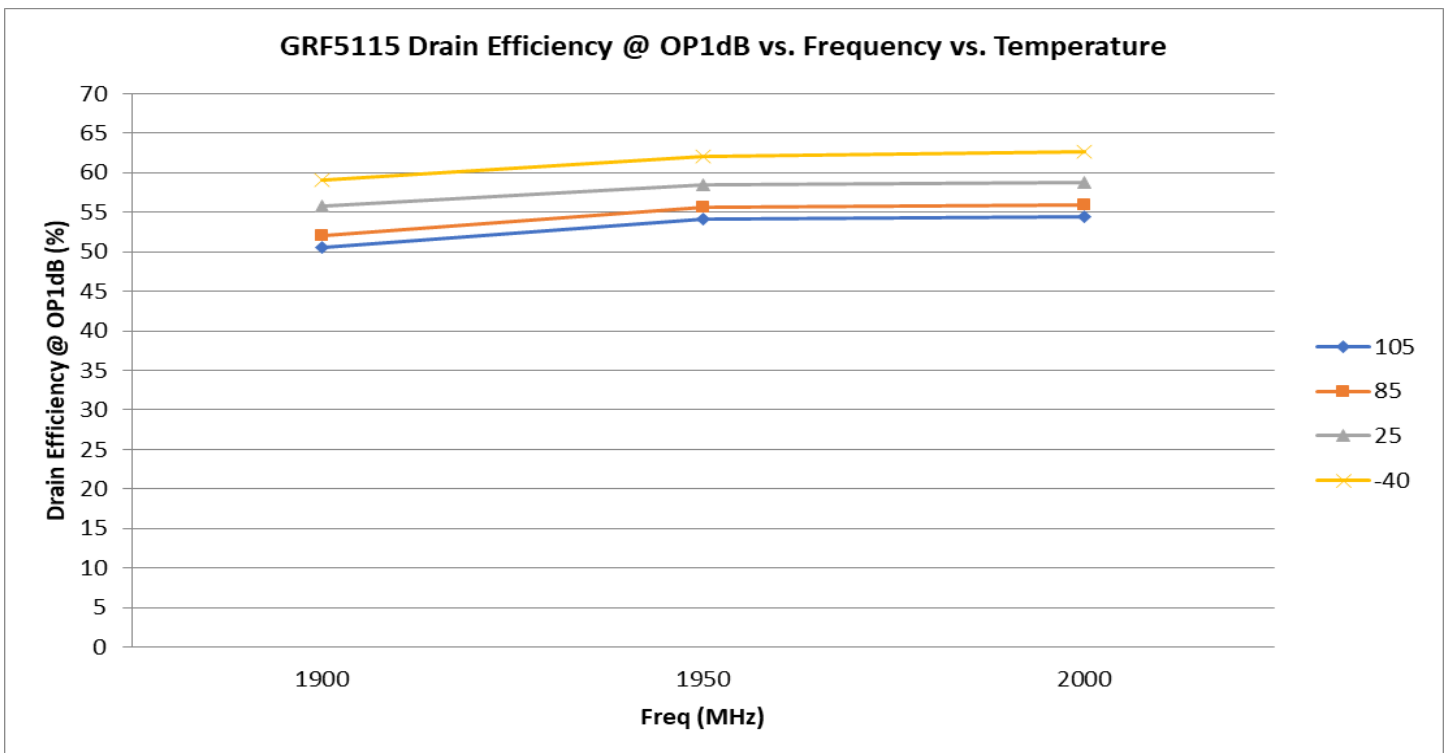
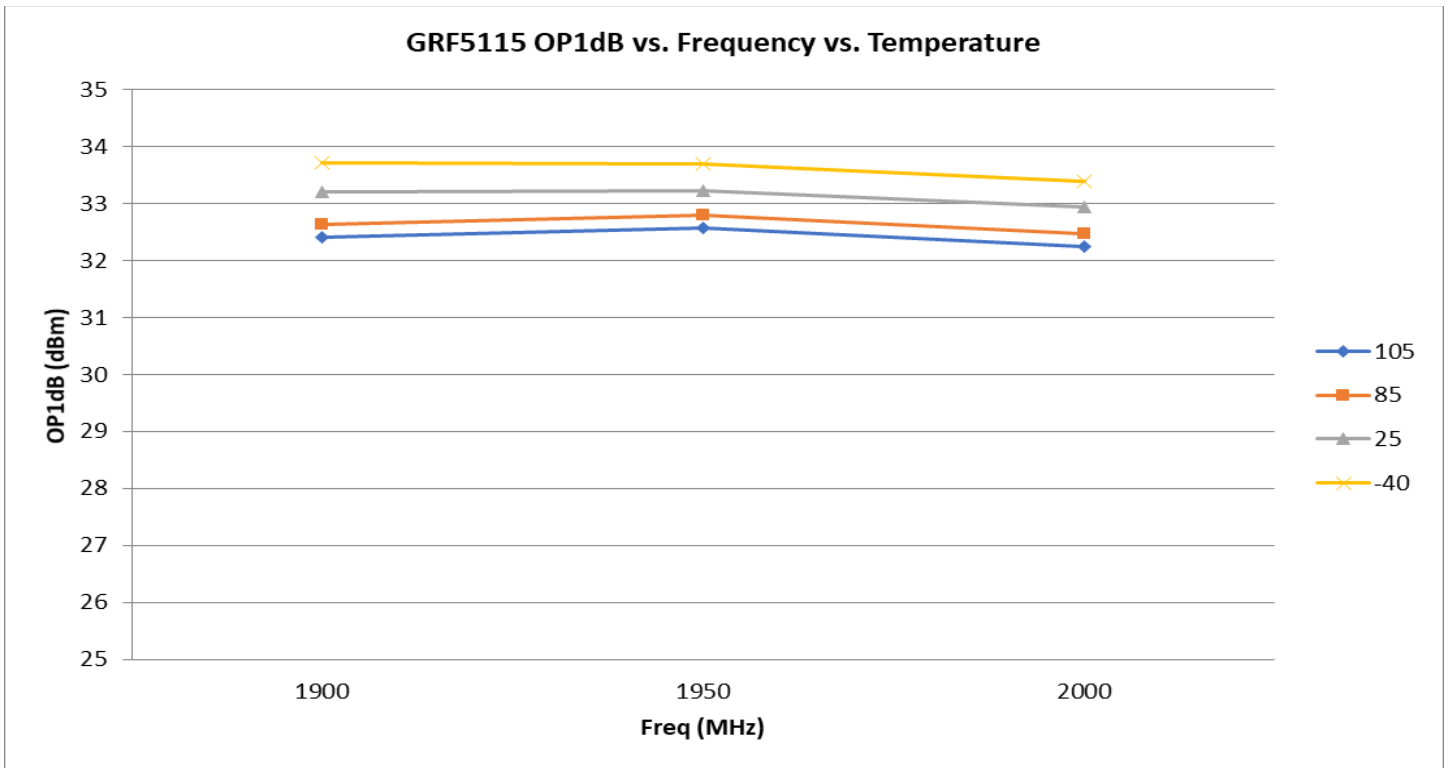



Released

GRF5115

33.0 dBm Power-LNA™
Tuning Range: 0.1 – 2.7 GHz

GRF5115 Evaluation Board Data: (1.9 to 2.0 GHz Tune)

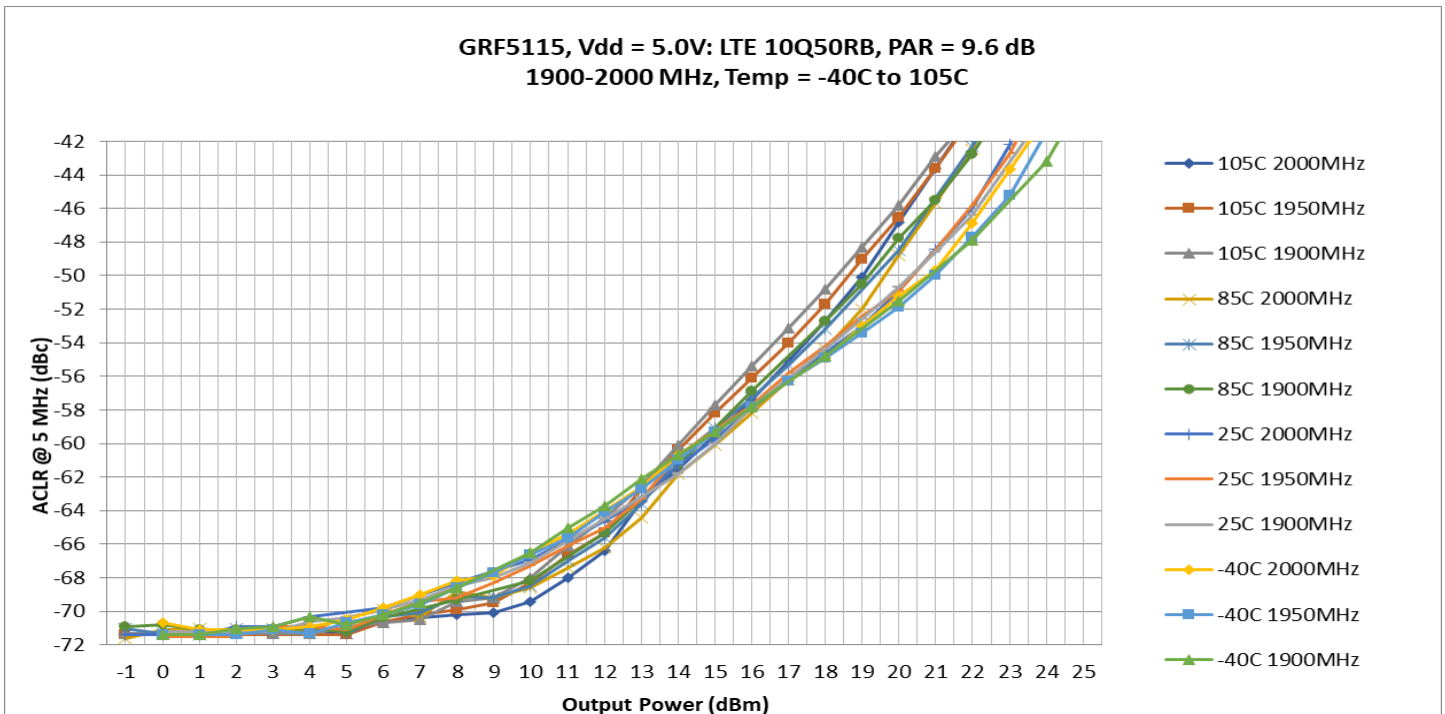
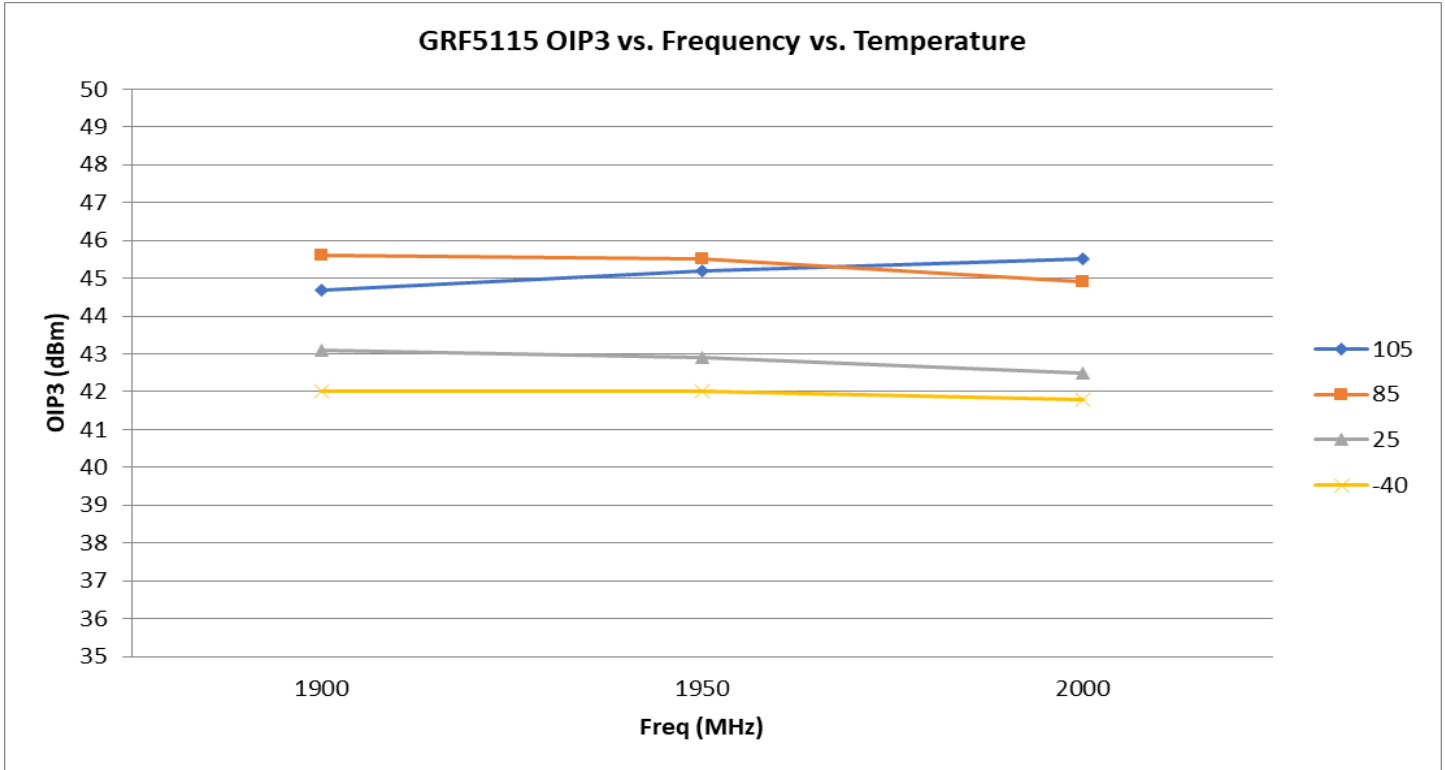



Released

GRF5115

33.0 dBm Power-LNA™
Tuning Range: 0.1 – 2.7 GHz

GRF5115 Evaluation Board S-Pars: (1.9 to 2.0 GHz Tune)

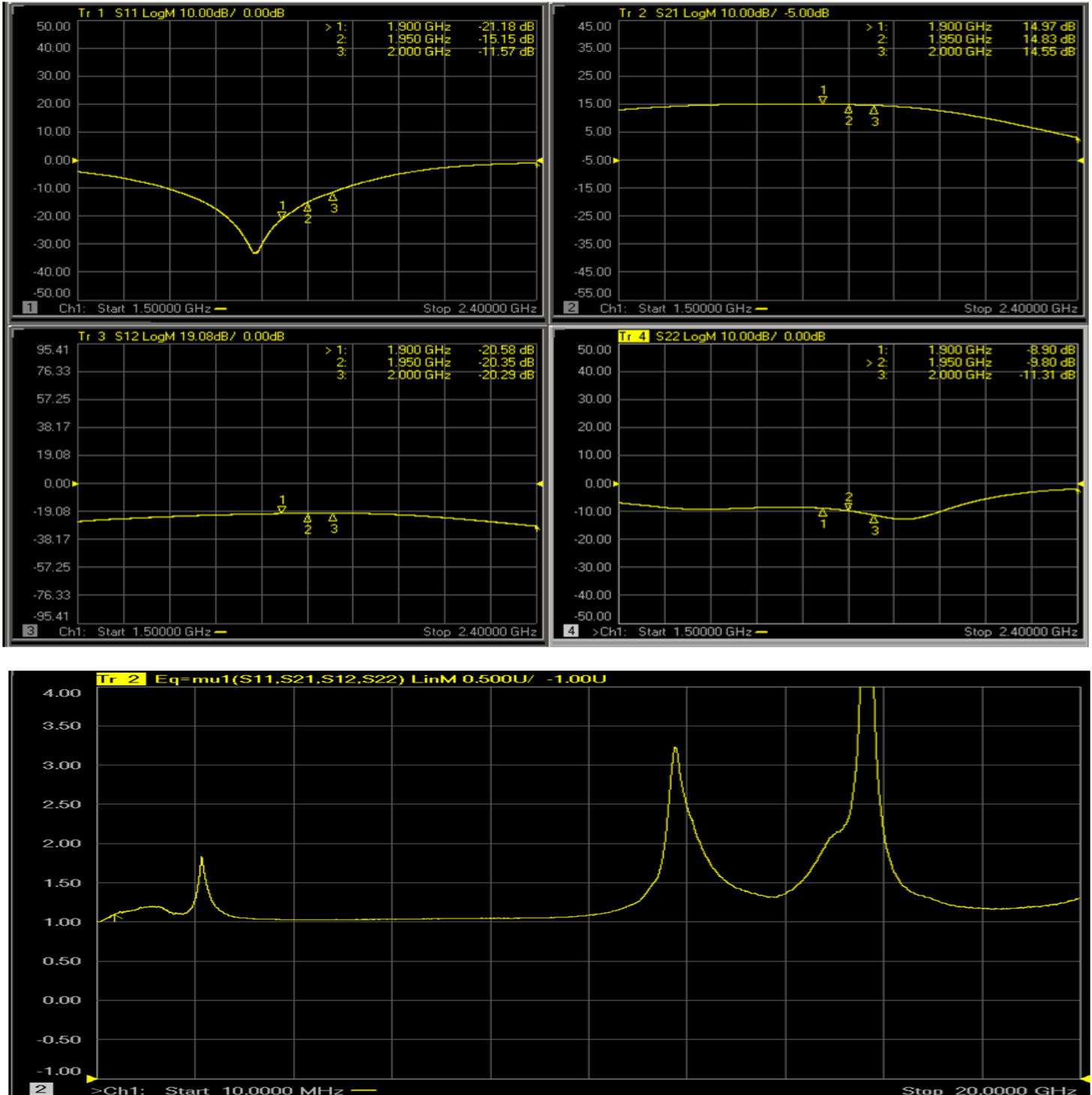

Note: Mu factor ≥ 1.0 implies unconditional stability.

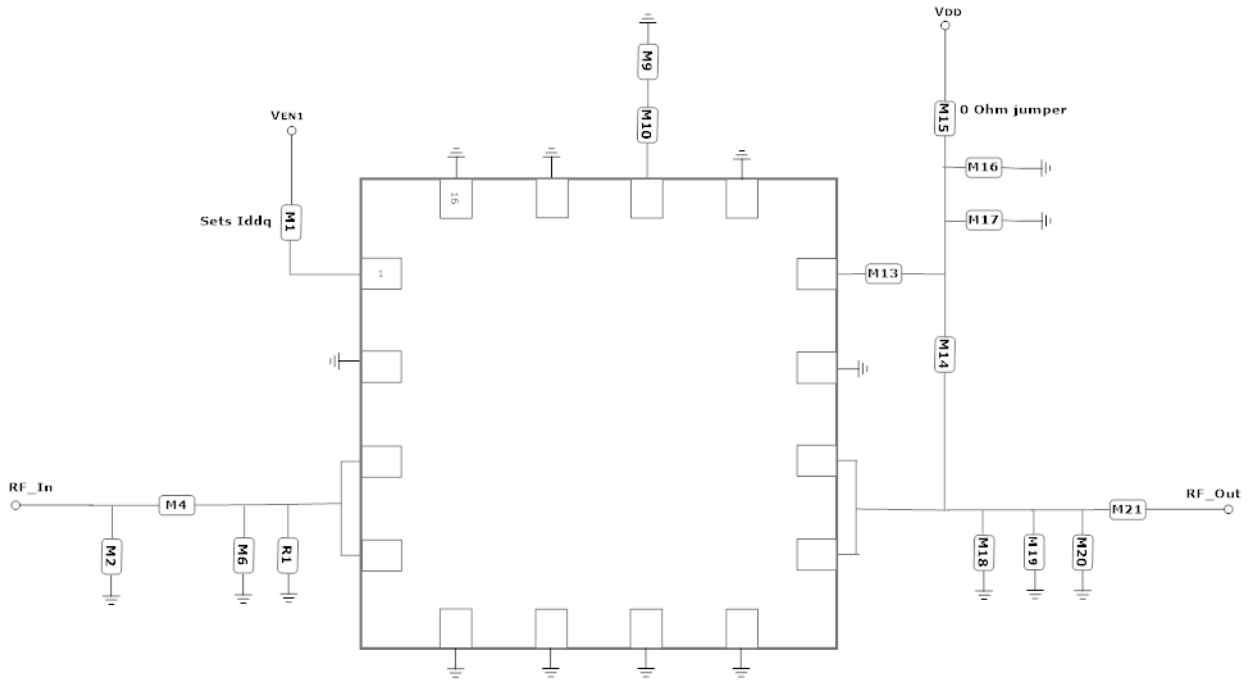

GRF5115 Application Schematic

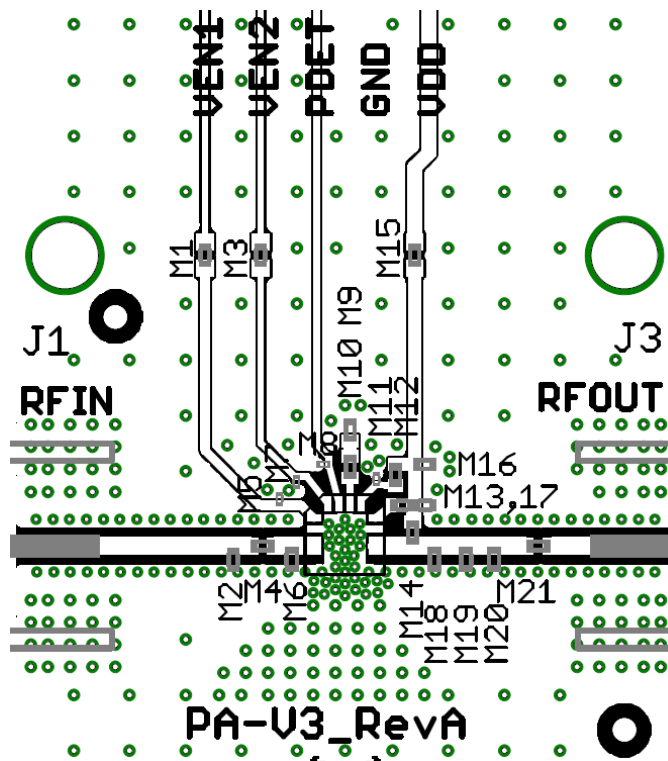

GRF5115 Evaluation Board Assembly Drawing



Released

GRF5115

33.0 dBm Power-LNA™
Tuning Range: 0.1 – 2.7 GHz

GRF5115 Evaluation Board BOM: (1.9 to 2.0 GHz Tune)

Component	Type	Manufacturer	Family	Value	Package Size	Substitution
M1 (See curves)	Resistor	Various	5%	Sets Iddq	0402	ok
M2	Inductor	Murata	LQP	6.2 nH	0402	ok
M4	Capacitor	Murata	GJM	1.5 pF	0402	ok
M6	Capacitor	Murata	GJM	3.9 pF	0402	ok
R1 (Adjacent M6)	Resistor	Various	5%	15k Ohm	0402	ok
M9	Resistor	Various	5%	100k Ohm	0402	ok
M10	Resistor	Various	—	0 Ohm	0402	ok
M13	Resistor	Various	5%	150 Ohm	0402	ok
M14	Inductor	Coilcraft	HP	8.2 nH	0402	ok
M15	Resistor	Various	—	0 Ohm	0402	ok
M16	Capacitor	Murata	GRM	0.1 uF	0402	ok
M17	Capacitor	Murata	GRM	100 pF	0402	ok
M18	Capacitor	Murata	GJM	3.9 pF	0402	ok
M19	DNP	—	—	—	0402	ok
M20	DNP	—	—	—	0402	ok
M21	Capacitor	Murata	GJM	15 pF	0402	ok
Evaluation board	PA-V3_RevA					



Released

GRF5115

33.0 dBm Power-LNA™
Tuning Range: 0.1 – 2.7 GHz

GRF5115 Bias Resistor M1 Selection Curves; Note: R1: 15k ohms; M9: 100k ohms

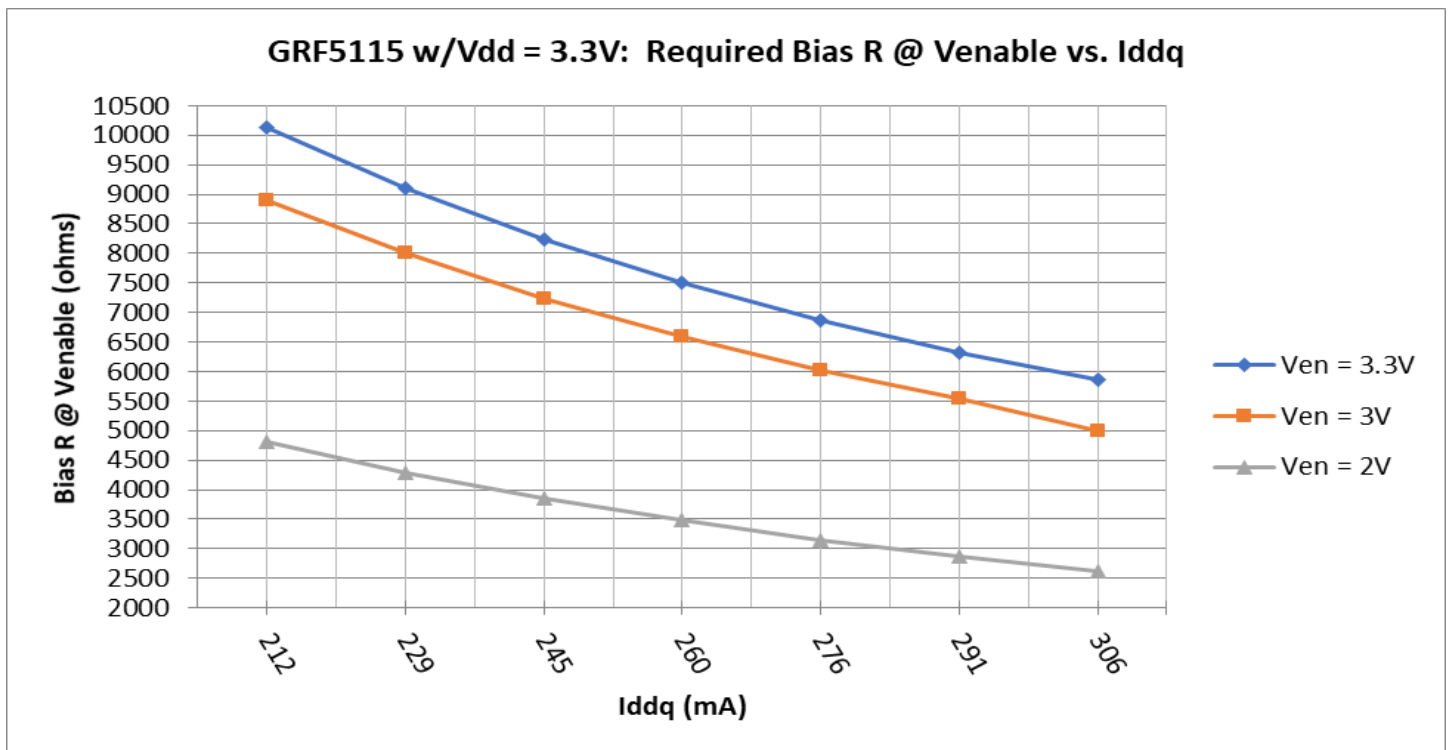
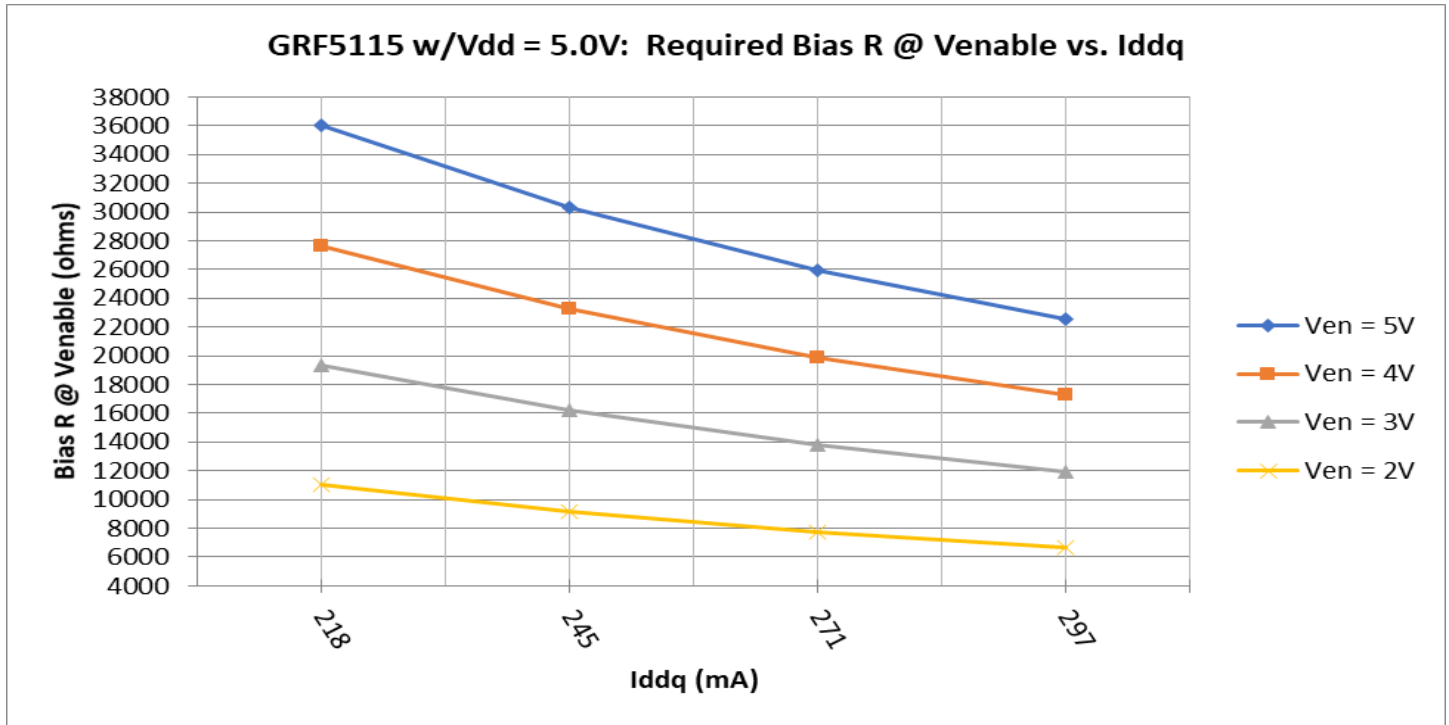

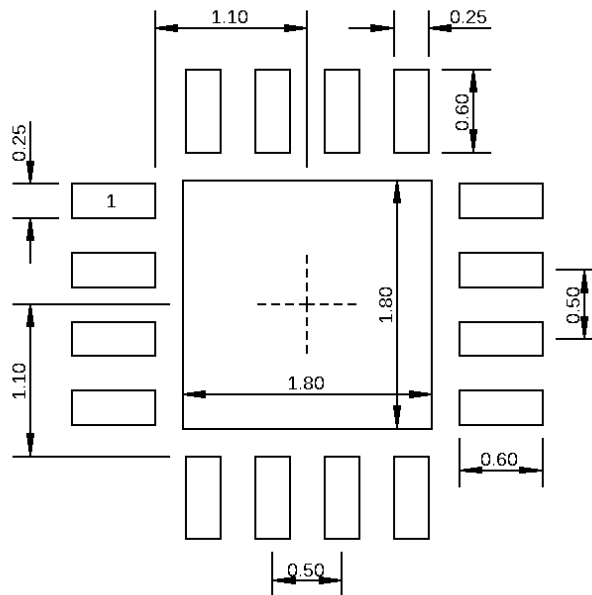

Dimensions in millimeters

3.0 mm QFN-16 Suggested PCB Footprint (Top View)

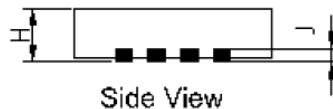
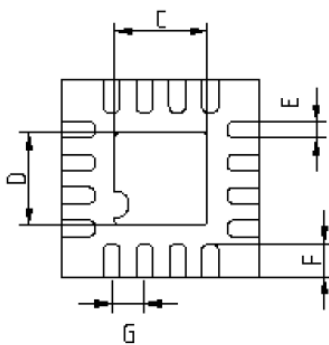
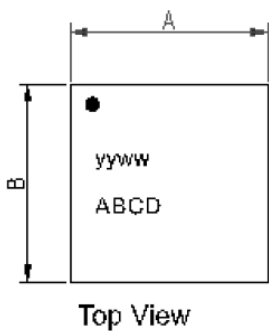

Dimensions (MM)	
A	3.0 Bsc
B	3.0 Bsc
C	1.40 +/- 0.10
D	1.40 +/- 0.10
E	.25 + 0.05 / - 0.07
F	.50 +/- 0.05
G	.50 Bsc.
H	.85 +/- 0.05
J	.20 Ref.

3.0 mm QFN-16 Package Dimensions

Tape and Reel Information:

Guerrilla RF's Tape and Reel specification complies with the Electronics Industries Association (EIA) standards for 'Embossed Carrier Tape of Surface Mount Components for Automatic Handling'. Reference EIA-481. See the table on the following page for Tape and Reel specifications along with units per reel.

Devices are loaded with pins down into the carrier pocket with protective cover tape, wound into a plastic reel. Each reel will be packaged in a cardboard box. There will be product labels on the reel, the protective ESD bag and the outside surface of the box.

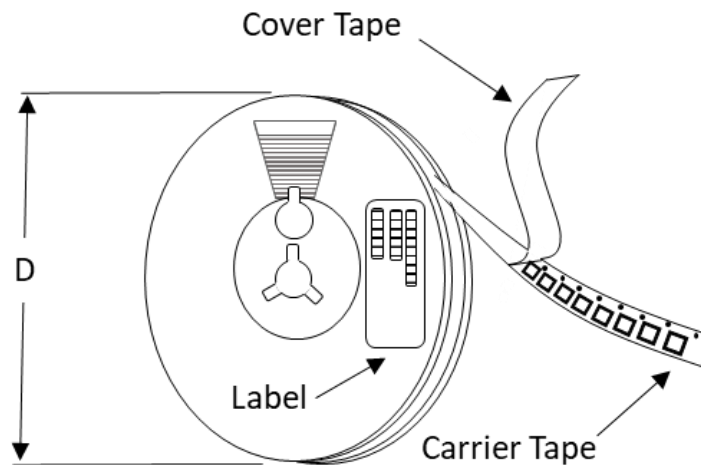

Tape and Reel Packaging with Reel Diameter Noted (D)

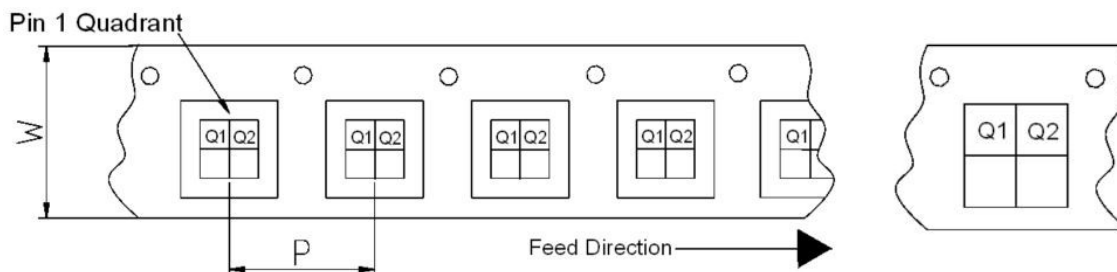

Carrier Tape Width (W), Pitch (P), Feed Direction and Pin 1 Quadrant Information



Released

GRF5115

33.0 dBm Power-LNA™
Tuning Range: 0.1 – 2.7 GHz

Tape and Reel Specification and Device Package Information Table

Package				Carrier Tape			Reel	
Type	Dimensions (mm)	Leads	Weight (mg)	Width (W) (mm)	Pocket Pitch (P) (mm)	Pin 1 Quadrant	Diameter (D) (inches)	Units per Reel
QFN	2.0 x 2.0 x 0.50	12	7	8	4	Q1	7	2500
QFN	3.0 x 3.0 x 0.85	16	24	12	8	Q1	7	1500
DFN	1.5 x 1.5 x 0.45	6	4	8	4	Q1	7	2500
DFN	2.0 x 2.0 x 0.75	8	12	8	4	Q1	7	2500
LFM	3.5 x 3.5 x 0.75	See	TBD	12	8	Q2	7	1500
LFM	4.0 x 4.0 x 0.75	See note	TBD	12	8	Q2	7	1500

Note: Lead count may vary. Reference applicable product data sheet



Released

GRF5115

33.0 dBm Power-LNA™
Tuning Range: 0.1 – 2.7 GHz

Data Sheet Release Status:	Notes
Advance	S-parameter and NF data based on EM simulations for the fully packaged device using foundry supplied transistor s-parameters. Linearity estimates based on device size, bias condition and experience with related devices.
Preliminary	All data based on evaluation board measurements in the Guerrilla RF Applications Lab.
Released	All data based on device qualification data. Typically, this data is nearly identical to the data found in the preliminary version. Max and min values for key RF parameters are included.

Information in this datasheet is specific to the Guerrilla RF, Inc. ("Guerrilla RF") product identified.

This datasheet, including the information contained in it, is provided by Guerrilla RF as a service to its customers and may be used for informational purposes only by the customer. Guerrilla RF assumes no responsibility for errors or omissions on this datasheet or the information contained herein. Information provided is believed to be accurate and reliable, however, no responsibility is assumed by Guerrilla RF for its use, nor for any infringement of patents, or other rights of third parties, resulting from its use. Guerrilla RF assumes no liability for any datasheet, datasheet information, materials, products, product information, or other information provided hereunder, including the sale, distribution, reproduction or use of Guerrilla RF products, information or materials.

No license, whether express, implied, by estoppel, by implication or otherwise is granted by this datasheet for any intellectual property of Guerrilla RF, or any third party, including without limitation, patents, patent rights, copyrights, trademarks and trade secrets. All rights are reserved by Guerrilla RF.

All information herein, products, product information, datasheets, and datasheet information are subject to change and availability without notice. Guerrilla RF reserves the right to change component circuitry, recommended application circuitry and specifications at any time without prior notice. Guerrilla RF may further change its datasheet, product information, documentation, products, services, specifications or product descriptions at any time, without notice. Guerrilla RF makes no commitment to update any materials or information and shall have no responsibility whatsoever for conflicts, incompatibilities, or other difficulties arising from any future changes.

GUERRILLA RF INFORMATION, PRODUCTS, PRODUCT INFORMATION, DATASHEETS AND DATASHEET INFORMATION ARE PROVIDED "AS IS" AND WITHOUT WARRANTY OF ANY KIND, WHETHER EXPRESS, IMPLIED, STATUTORY, OR OTHERWISE, INCLUDING FITNESS FOR A PARTICULAR PURPOSE OR USE, MERCHANTABILITY, PERFORMANCE, QUALITY OR NON-INFRINGEMENT OF ANY INTELLECTUAL PROPERTY RIGHT; ALL SUCH WARRANTIES ARE HEREBY EXPRESSLY DISCLAIMED. GUERRILLA RF DOES NOT WARRANT THE ACCURACY OR COMPLETENESS OF THE INFORMATION, TEXT, GRAPHICS OR OTHER ITEMS CONTAINED WITHIN THESE MATERIALS. GUERRILLA RF SHALL NOT BE LIABLE FOR ANY DAMAGES, INCLUDING BUT NOT LIMITED TO ANY SPECIAL, INDIRECT, INCIDENTAL, STATUTORY, OR CONSEQUENTIAL DAMAGES, INCLUDING WITHOUT LIMITATION, LOST REVENUES OR LOST PROFITS THAT MAY RESULT FROM THE USE OF THE MATERIALS OR INFORMATION, WHETHER OR NOT THE RECIPIENT OF MATERIALS HAS BEEN ADVISED OF THE POSSIBILITY OF SUCH DAMAGE.

Customers are solely responsible for their use of Guerrilla RF products in the Customer's products and applications or in ways which deviate from Guerrilla RF's published specifications, either intentionally or as a result of design defects, errors, or operation of products outside of published parameters or design specifications. Customers should include design and operating safeguards to minimize these and other risks. Guerrilla RF assumes no liability or responsibility for applications assistance, customer product design, or damage to any equipment resulting from the use of Guerrilla RF products outside of stated published specifications or parameters.

Guerrilla RF Proprietary Information. Guerrilla RF™ and the composite logo of Guerrilla RF™ are trademarks of Guerrilla RF, Inc. ©2014 Guerrilla RF, Inc. All rights reserved.

X-ON Electronics

Largest Supplier of Electrical and Electronic Components

Click to view similar products for [RF Development Tools](#) category:

Click to view products by [Guerrilla RF](#) manufacturer:

Other Similar products are found below :

[MAAM-011117](#) [MAAP-015036-DIEEV2](#) [EV1HMC1113LP5](#) [EV1HMC6146BLC5A](#) [EV1HMC637ALP5](#) [EVAL-ADG919EBZ](#) [ADL5363-EVALZ](#) [LMV228SDEVAL](#) [SKYA21001-EVB](#) [SMP1331-085-EVB](#) [EV1HMC618ALP3](#) [EVAL01-HMC1041LC4](#) [MAAL-011111-000SMB](#)
[MAAM-009633-001SMB](#) [MASW-000936-001SMB](#) [107712-HMC369LP3](#) [107780-HMC322ALP4](#) [SP000416870](#) [EV1HMC470ALP3](#)
[EV1HMC520ALC4](#) [EV1HMC244AG16](#) [MAX2614EVKIT#](#) [124694-HMC742ALP5](#) [SC20ASATEA-8GB-STD](#) [MAX2837EVKIT+](#)
[MAX2612EVKIT#](#) [MAX2692EVKIT#](#) [EV1HMC629ALP4E](#) [SKY12343-364LF-EVB](#) [108703-HMC452QS16G](#) [EV1HMC863ALC4](#)
[EV1HMC427ALP3E](#) [119197-HMC658LP2](#) [EV1HMC647ALP6](#) [ADL5725-EVALZ](#) [106815-HMC441LM1](#) [EV1HMC1018ALP4](#)
[UXN14M9PE](#) [MAX2016EVKIT](#) [EV1HMC939ALP4](#) [MAX2410EVKIT](#) [MAX2204EVKIT+](#) [EV1HMC8073LP3D](#) [SIMSA868-DKL](#)
[SIMSA868C-DKL](#) [SKY65806-636EK1](#) [SKY68020-11EK1](#) [SKY67159-396EK1](#) [SKY66181-11-EK1](#) [SKY65804-696EK1](#)