



## Product Description

GRF5504 is a high efficiency PA that delivers up to 3.5 Watts at Psat with Vcc at 5.0 volts and a low Iccq of 125 mA. PAE at Psat is roughly 64%.

The device can be tuned over a range of frequencies from around 400 MHz to 500 MHz with typical fractional bandwidths of 3 to 5%.

For frequencies in the 700-1000 MHz range, GRF5509 offers slightly higher output power and high efficiency with the same package and pinouts.

Consult with the GRF applications engineering team for custom tuning/evaluation board data.

## Features

Reference: 5.0V/460MHz/CW

- Gain: 41.0 dB
- Iccq: 125 mA
- OP1dB: 34.8 dBm
- Psat: 35.5 dBm
- PAE at Psat: 64%
  
- Flexible Bias Voltage and Current
- Process: InGaP HBT

## Applications

- UHF
- Automatic Meter Reader
- RFID

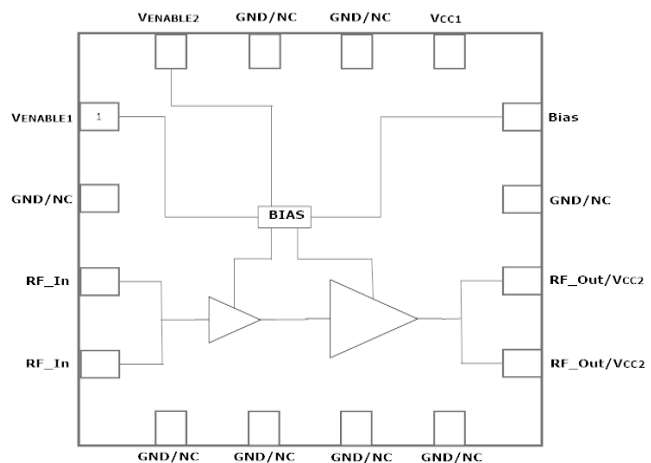

3.0 x 3.0 mm QFN-16



Preliminary

# GRF5504

High Efficiency, 3.5 Watt PA  
Tuning Range: 0.4 to 0.5 GHz

## Absolute Ratings:

Parameter	Symbol	Min.	Max.	Unit
Drain Voltage	V <sub>CC</sub>		5.5	V
Transient Average RF Input Power: (Load VSWR < 2:1; Duration: <1 hour)	P <sub>IN MAX</sub>		TBD	dBm
Operating Temperature (Package Heat Sink)	T <sub>AMB</sub>	-40	85	°C
Maximum Junction Temperature (MTTF > 10 <sup>6</sup> Hours)	T <sub>MAX</sub>		170	°C
Maximum Dissipated Power Stage 1 (at P <sub>sat</sub> )	P <sub>DISS MAX</sub>		400	mW
Maximum Dissipated Power Stage 2 (at P <sub>sat</sub> )	P <sub>DISS MAX</sub>		3800	mW
Ruggedness: V <sub>cc</sub> : 5.0 volt at P <sub>sat</sub> ( all phase angles)	VSWR	8:1		—
Electrostatic Discharge:				
Human Body Model: (TBD)	HBM	250		V
Storage:				
Storage Temperature	T <sub>STG</sub>	-65	150	°C
Moisture Sensitivity Level	MSL		1	—



Caution! ESD Sensitive Device



Exceeding Absolute Maximum Rating conditions may cause permanent damage to the device.

**Note:** For manufacturing information, see the [Guerrilla-RF.com](http://Guerrilla-RF.com) website for the following document located on the GRF5504 landing page: Manufacturing Note—MN-001 Product Tape and Reel, Solderability and Package Outline Specification.

[Link to manufacturing note](#)

## Pin Out (Top View)

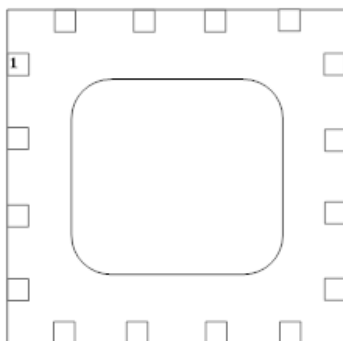

## Pin Assignments:

Pin	Name	Description	Note
1	VEN1	Enable1 Voltage Input	VEN1 and series resistor set IccQ for the input stage. VENABLE < =0.2 volts disables device.
2	GND/NC	No Connect or Ground	No internal connection to die
3	RF_In	RF Input	Pins 3-4 tied together on system board
4	RF_In	RF Input	Pins 3-4 tied together on system board
5	GND/NC	Ground or No Connect	No internal connection to die
6	GND/NC	Ground or No Connect	No internal connection to die
7	GND/NC	Ground or No Connect	No internal connection to die
8	GND/NC	Ground or No Connect	No internal connection to die
9	RF_Out/Vcc2	PA Output/Bias Voltage	Pins 9-10 tied together on system board. Supply Vcc2 here.
10	RF_Out/Vcc2	PA Output/Bias	Pins 9-10 tied together on system board. Supply Vcc2 here.
11	GND/NC	Ground or No Connect	No internal connection to die
12	Bias	Bias Circuit Supply	Connect to Vcc2 through external resistor
13	Vcc1	Bias Voltage	Supply Vcc1 here.
14	GND/NC	Ground or No Connect	No internal connection to die
15	GND/NC	Ground or No Connect	No internal connection to die
16	VEN2	Enable2 Voltage Input	VEN2 and series resistor set IccQ for the output stage. VENABLE < =0.2 volts disables device.
PKG BASE	GND	Ground	Provides DC and RF ground for LNA, as well as thermal heat sink. Recommend multiple 8 mil vias beneath the package for optimal RF and thermal performance. Refer to evaluation board top layer graphic on schematic page.



Preliminary

# GRF5504

High Efficiency, 3.5 Watt PA  
Tuning Range: 0.4 to 0.5 GHz

## Nominal Operating Parameters:

Parameter	Symbol	Specification			Unit	Condition
		Min.	Typ.	Max.		
<b>Performance:</b> (450 to 470 MHz Tune @25C)						<b>Bias: 5.0 V /120 mA Iccq unless otherwise noted.</b>
Test Frequency	F <sub>TEST</sub>		460		MHz	
Gain (Small Signal)	S(2,1)		41.0		dB	
Output 1dB Compression Power	OP1dB		34.8		dBm	
Saturated Output Power	Psat		35.5		dBm	
Power Added Efficiency (at Psat)	PAE		64		%	RF Input: 0 dBm
Noise Figure	NF		4.2		dB	
Switching Rise Time	T <sub>RISE</sub>		TBD		ns	
Switching Fall Time	T <sub>FALL</sub>		TBD		ns	
Quiescent Supply Current	I <sub>CCQ</sub>		125		mA	V <sub>CC</sub> = Ven1/2 = 5.0 volts
Enable Current 1	I <sub>ENABLE1</sub>		1.2		mA	
Enable Current 2	I <sub>ENABLE2</sub>		TBD		mA	
<b>Disabled Mode</b>						
Supply Current (Leakage)	I <sub>CC</sub>		1.0		uA	
<b>Thermal Data (RF Applied)</b>						
Thermal Resistance: (IR Scan Method)	Θ <sub>JC</sub>		19		°C/W	RF Input: 0 dBm

Note: MTTF >10<sup>6</sup> hours for T<sub>JUNCTION</sub> < =170 degrees C.



Preliminary

# GRF5504

High Efficiency, 3.5 Watt PA  
Tuning Range: 0.4 to 0.5 GHz

## GRF5504 Evaluation Board Measured Data:

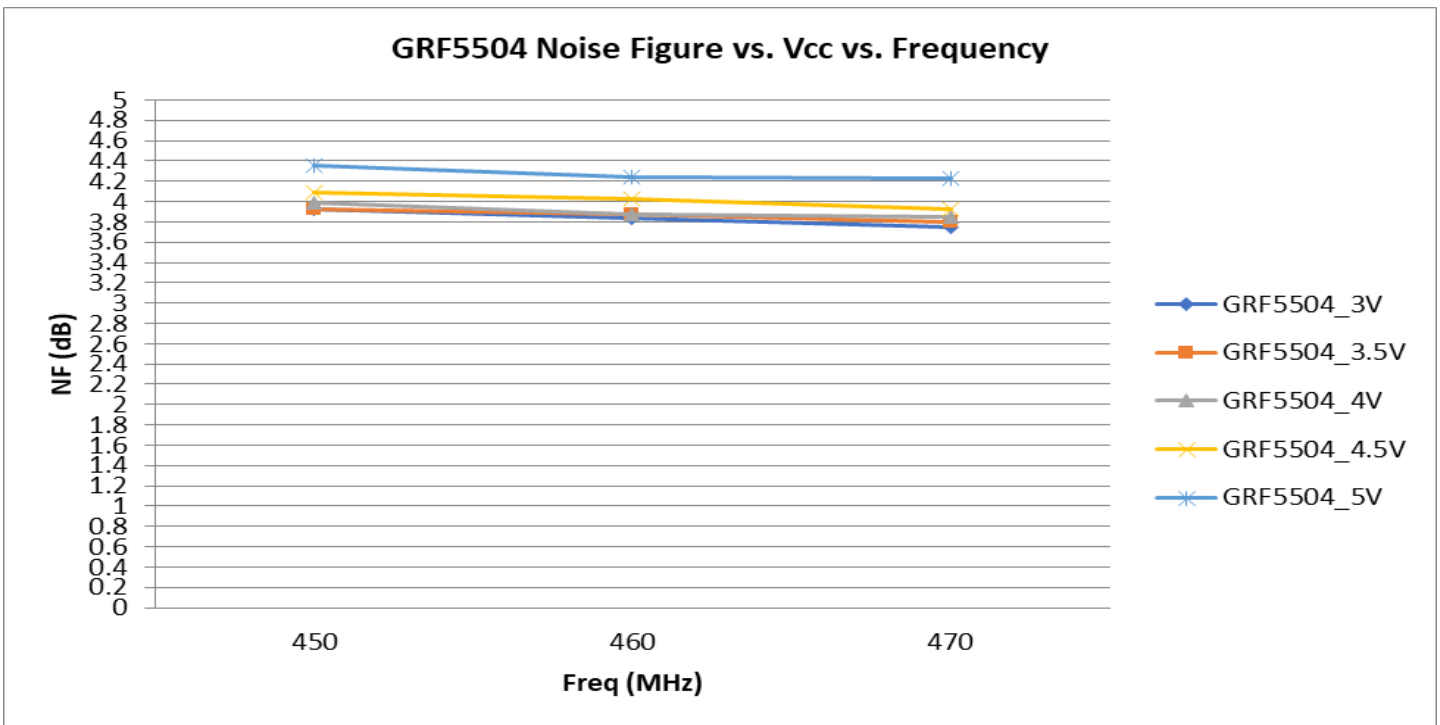
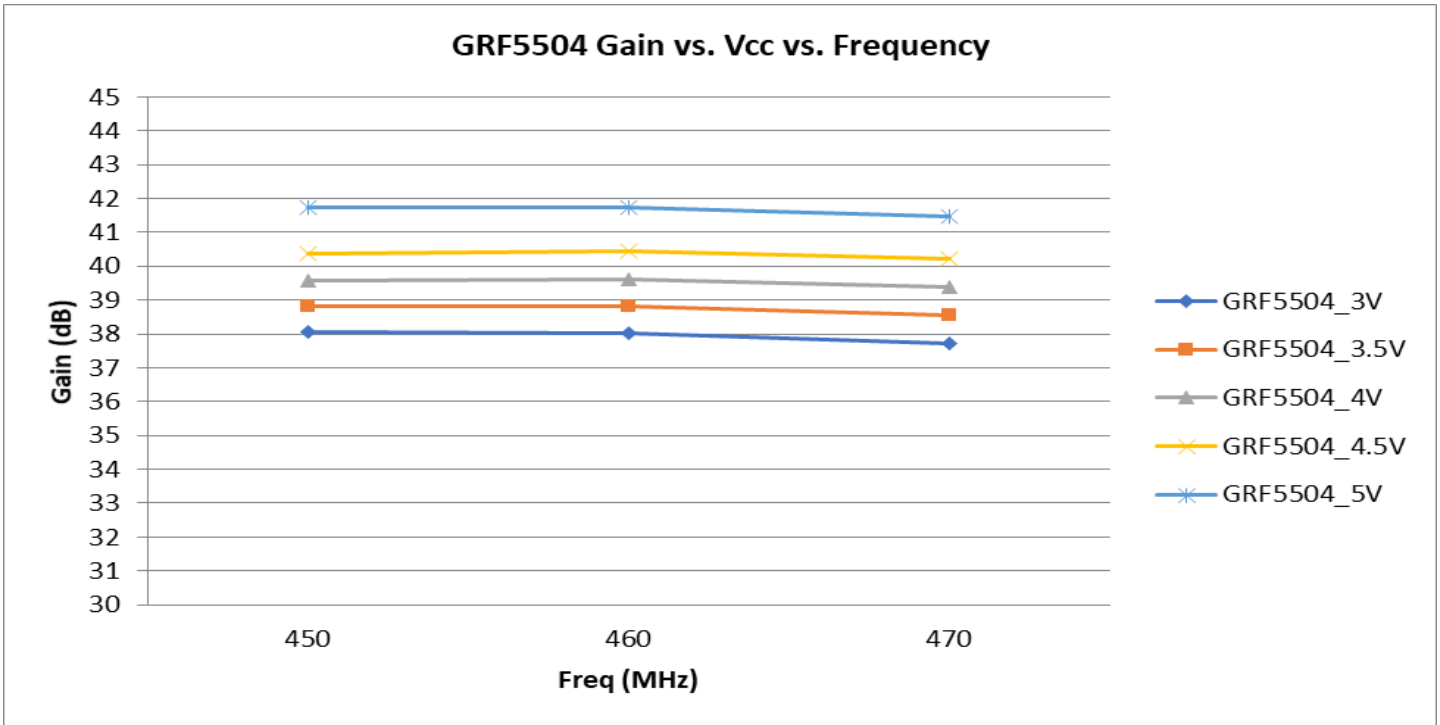



Preliminary

# GRF5504

High Efficiency, 3.5 Watt PA  
Tuning Range: 0.4 to 0.5 GHz

## GRF5504 Evaluation Board Measured Data:

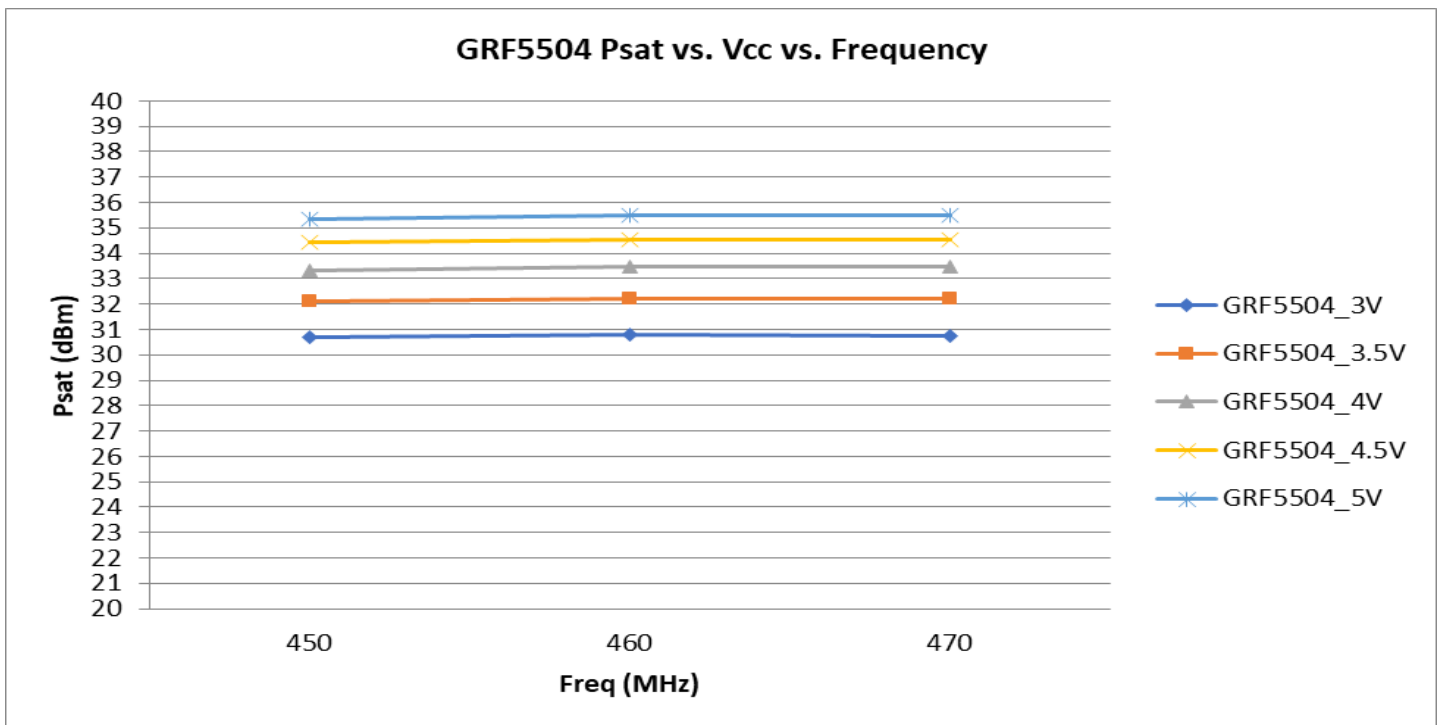
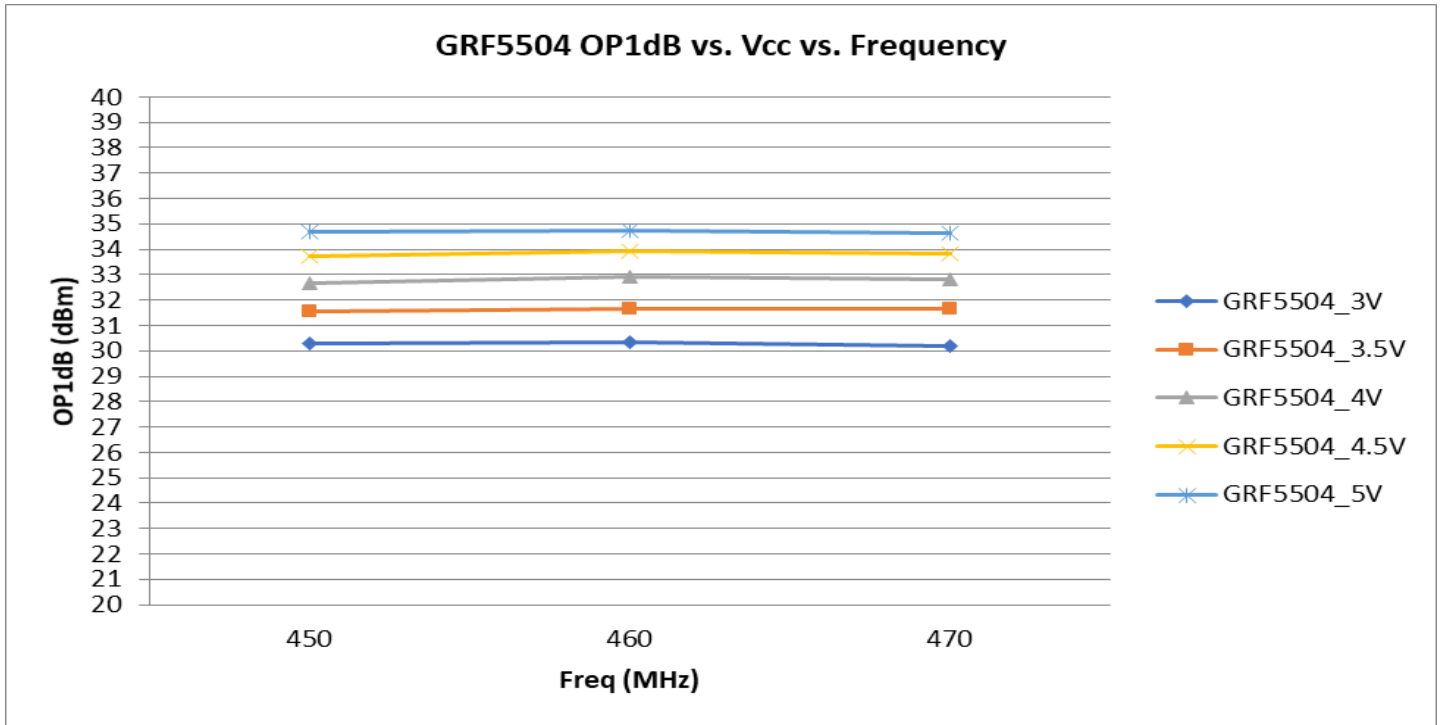



Preliminary

# GRF5504

High Efficiency, 3.5 Watt PA  
Tuning Range: 0.4 to 0.5 GHz

## GRF5504 Evaluation Board Measured Data:

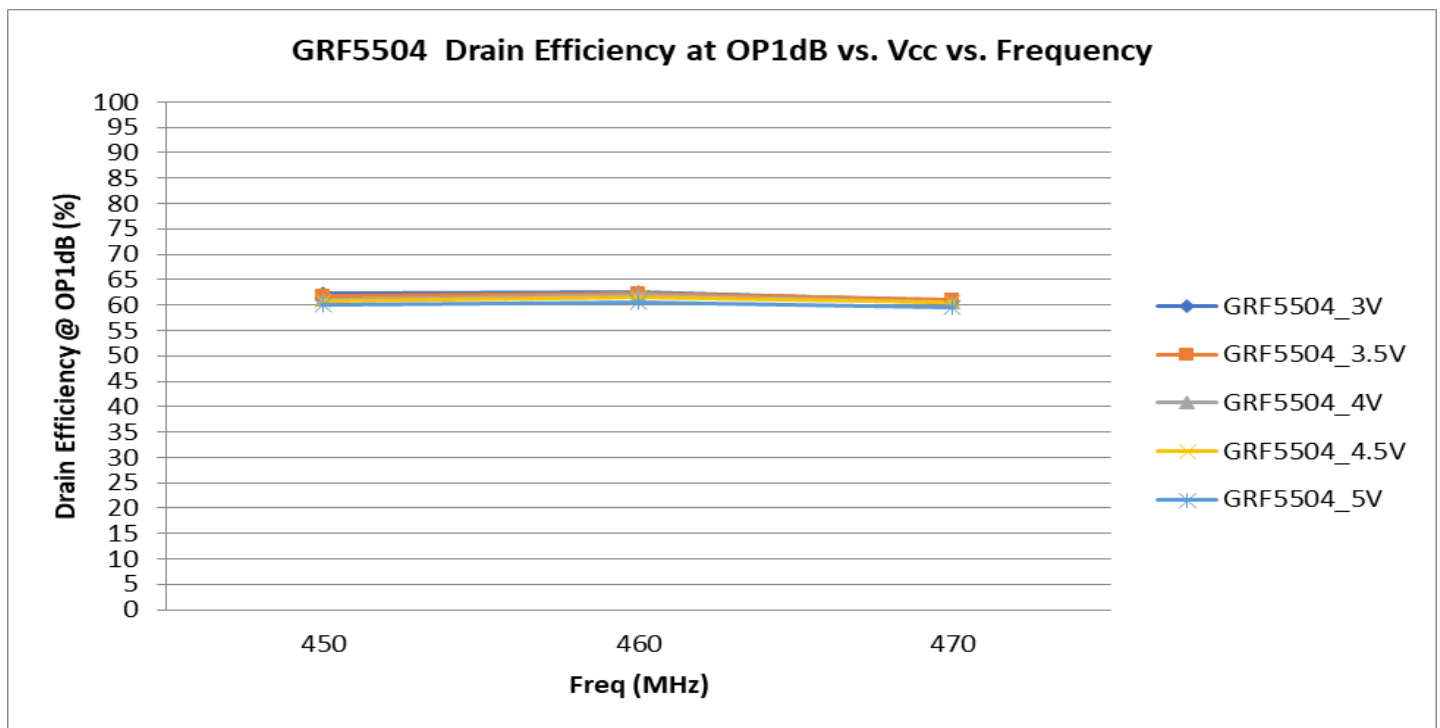
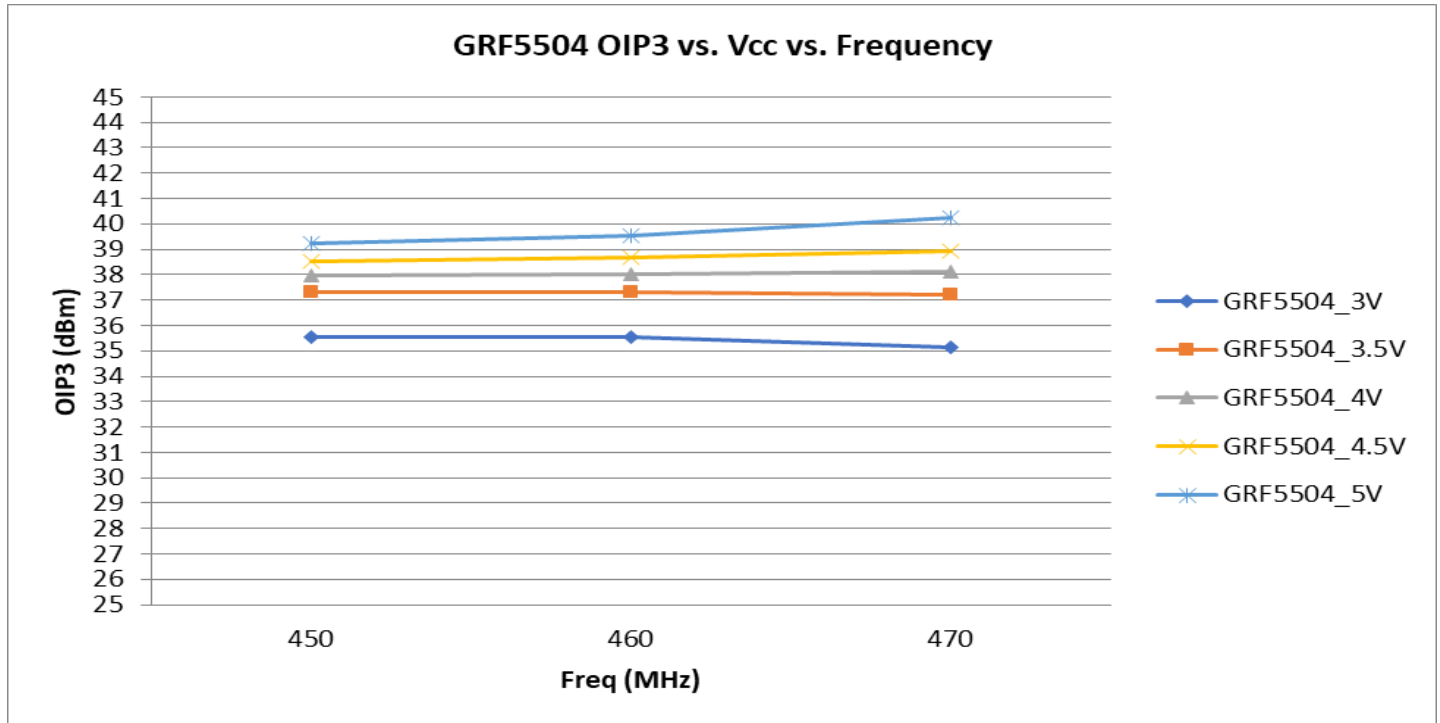



Preliminary

# GRF5504

High Efficiency, 3.5 Watt PA  
Tuning Range: 0.4 to 0.5 GHz

## GRF5504 Evaluation Board Measured Data:

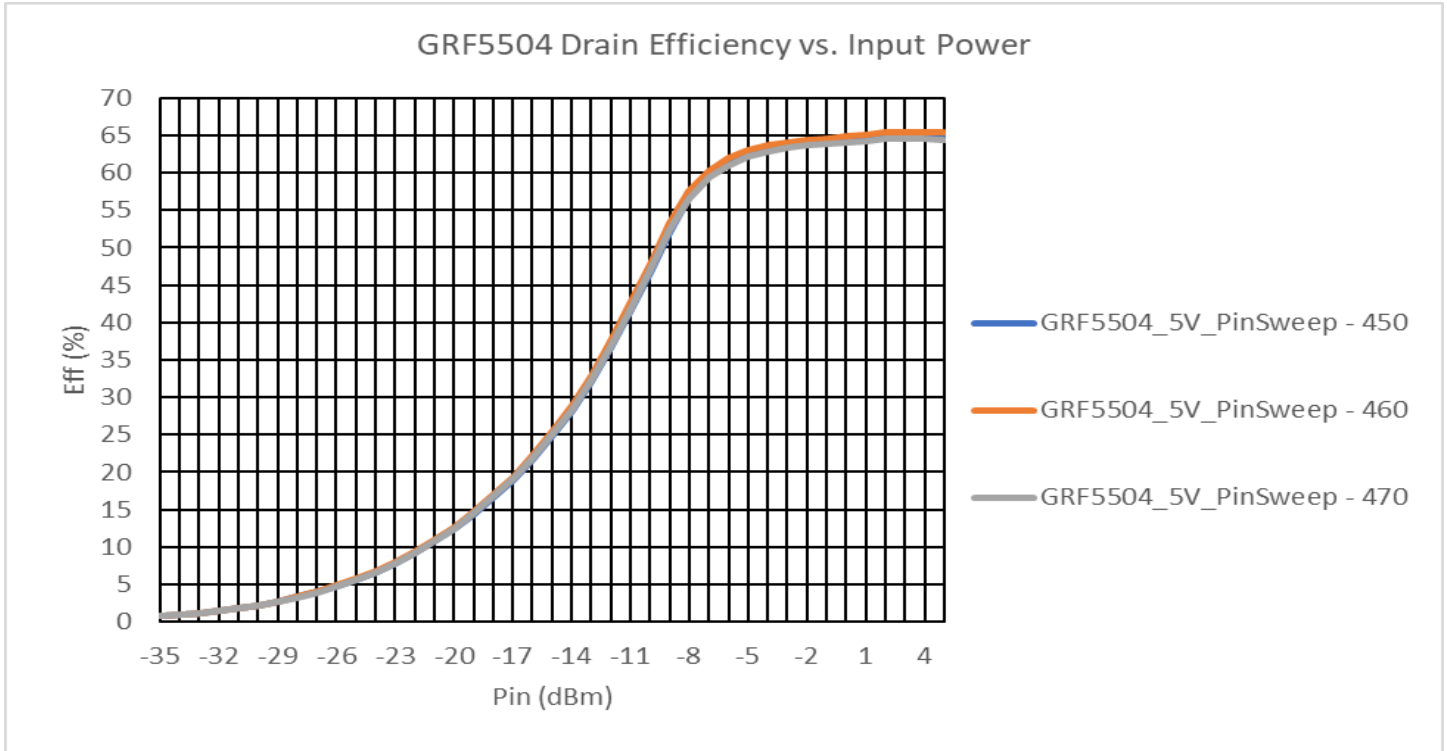





Preliminary

# GRF5504

High Efficiency, 3.5 Watt PA  
Tuning Range: 0.4 to 0.5 GHz

## GRF5504 Evaluation Board Small Signal S-Pars: (450 to 470 MHz Tune)

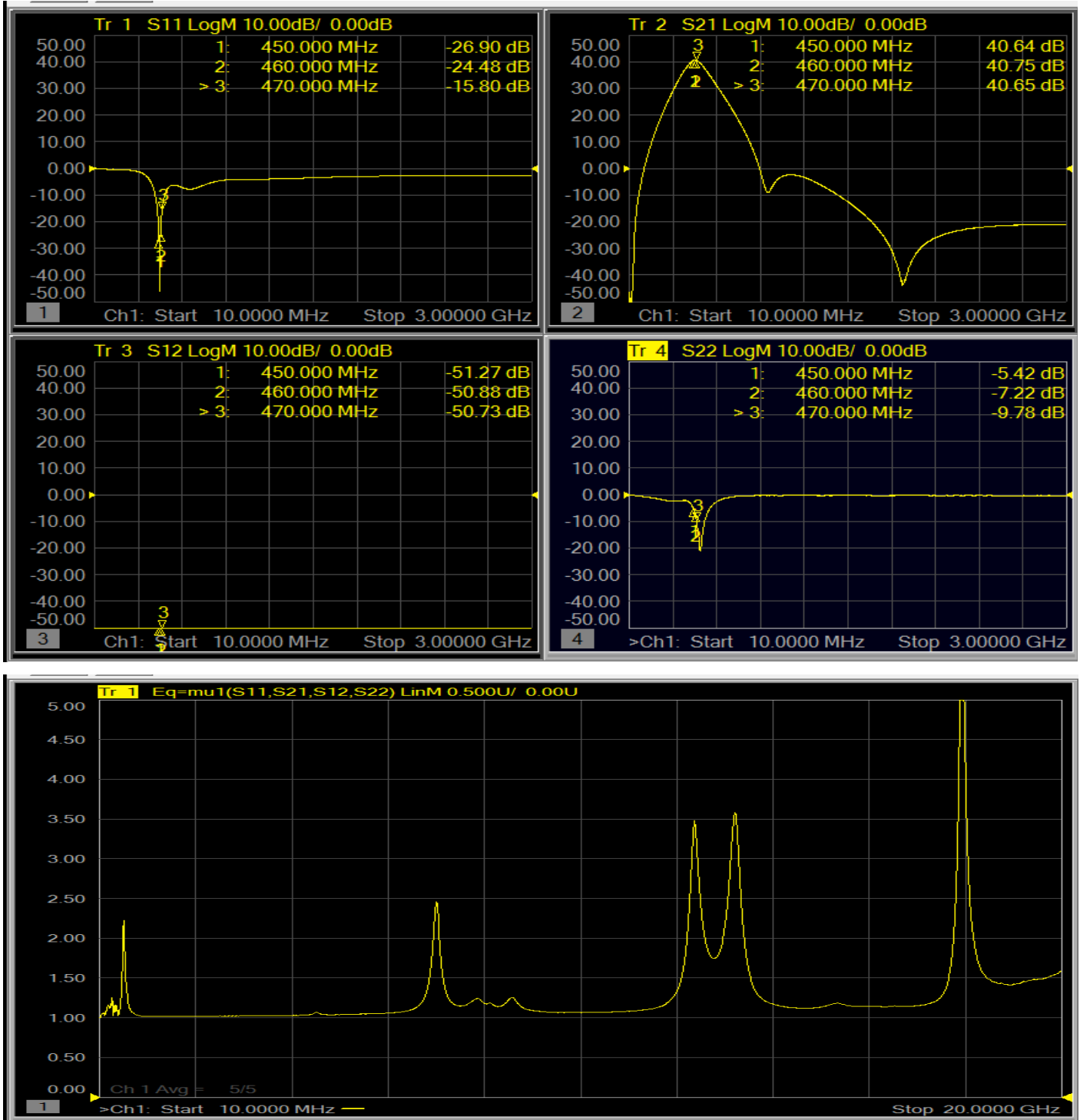

Note: Mu factor  $\geq 1.0$  implies unconditional stability



Preliminary

# GRF5504

High Efficiency, 3.5 Watt PA  
Tuning Range: 0.4 to 0.5 GHz

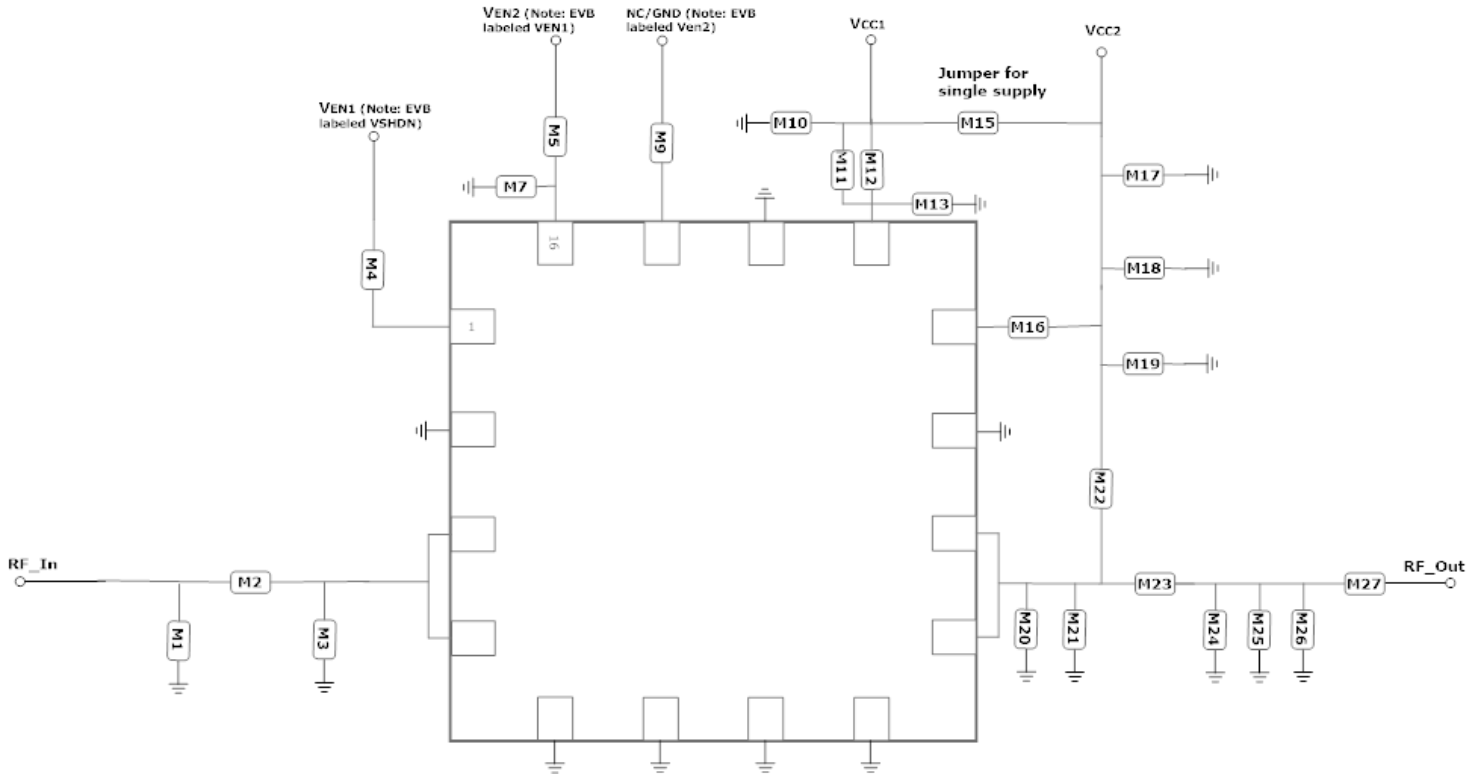

GRF5504 Application Schematic



Preliminary

# GRF5504

High Efficiency, 3.5 Watt PA  
Tuning Range: 0.4 to 0.5 GHz

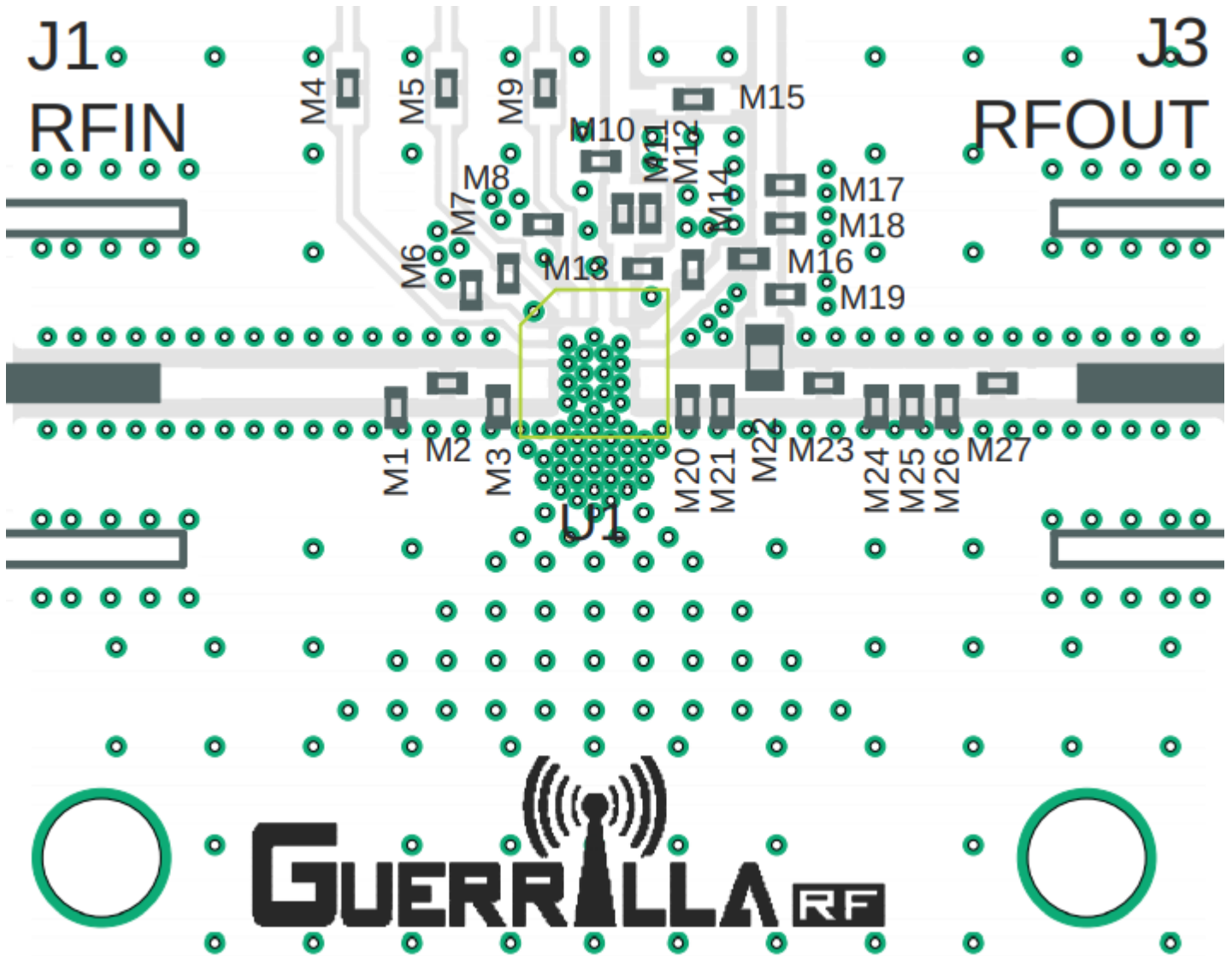

GRF5504 Evaluation Board Assembly Drawing (QFN16-30-24-B)



Preliminary

# GRF5504

High Efficiency, 3.5 Watt PA  
Tuning Range: 0.4 to 0.5 GHz

## GRF5504 Evaluation Board BOM: (450 to 470 MHz tune)

Vcc= Ven1= Ven2 = 5.0 volts

Component	Type	Manufacturer	Family	Value	Package Size	Substitution
M1	Inductor	Murata	LQG	6.8 nH	0402	ok
M2	Capacitor	Murata	GJM	27 pF	0402	ok
M4	Resistor	Various	5%	See table	0402	ok
M5	Resistor	Various	5%	See table	0402	ok
M10	Capacitor	Murata	GRM	0.1 uF	0402	ok
M11	Inductor	Murata	LQW	5.6 nH	0402	ok
M15	Resistor (Jumper)	Various	5%	0 Ohm	0402	ok
M16	Resistor (Jumper)	Various	5%	0 Ohm	0402	ok
M17	Capacitor	Murata	GRM	0.1 uF	0402	ok
M18	Capacitor	Murata	GRM	100 pF	0402	ok
M22	Inductor: High Q	Coilcraft	Micro Spring	23 nH	—	ok
M23	Inductor	Coilcraft	HP	3.3 nH	0402	ok
M25	Capacitor	Murata	GJM	20 pF	0402	ok
M27	Capacitor	Murata	GJM	15 pF	0402	ok
M3, M6, M7, M8, M9, M12, M13, M14, M19, M20, M21, M24, M26	DNP	—	—	—	—	—
Evaluation Board	QFN16-30-24-B					

## GRF5504 Bias Resistor (M4 and M5) Selection Table

Vdd1, 2 (V)	Ven1, 2 (V)	Iddq1 (mA)	Iddq2 (mA)	M4 (ohm)	M5 (ohm)
5	5	30	90	3300	6800
4.5	4.5	25	75	3600	6700
4	4	22	65	3300	5700
3.5	3.5	20	55	2700	4500
3	3	20	50	1900	2400

Guerrilla RF Proprietary Information. Guerrilla RF™ and the composite logo of Guerrilla RF™ are trademarks of Guerrilla RF, Inc. ©2014 Guerrilla RF, Inc. All rights reserved.

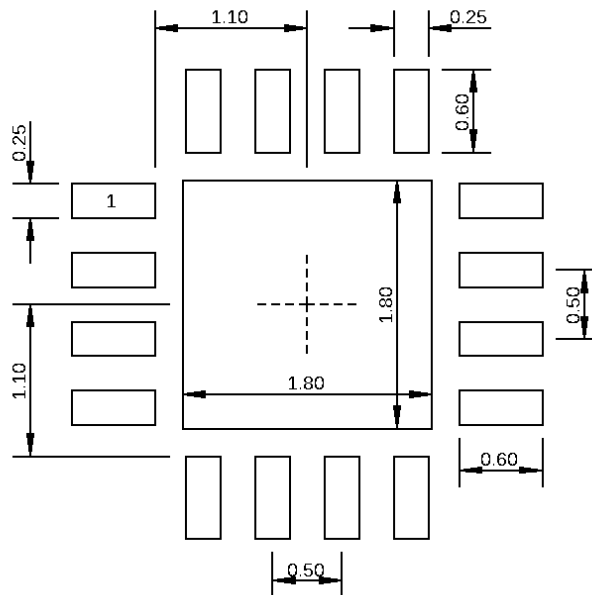

Dimensions in millimeters

### 3.0 mm QFN-16 Suggested PCB Footprint (Top View)

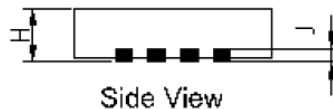
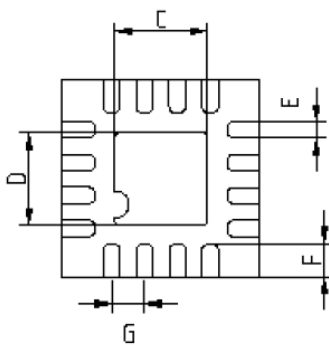
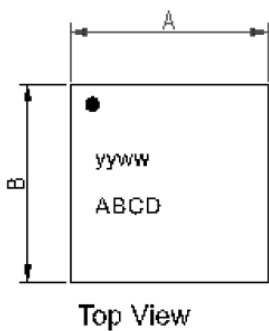

Dimensions (MM)	
A	3.0 Bsc
B	3.0 Bsc
C	1.40 +/- 0.10
D	1.40 +/- 0.10
E	.25 + 0.05 / - 0.07
F	.50 +/- 0.05
G	.50 Bsc.
H	.85 +/- 0.05
J	.20 Ref.

### 3.0 mm QFN-16 Package Dimensions

### Tape and Reel Information:

Guerrilla RF's Tape and Reel specification complies with the Electronics Industries Association (EIA) standards for 'Embossed Carrier Tape of Surface Mount Components for Automatic Handling'. Reference EIA-481. See the table on the following page for Tape and Reel specifications along with units per reel.

Devices are loaded with pins down into the carrier pocket with protective cover tape, wound into a plastic reel. Each reel will be packaged in a cardboard box. There will be product labels on the reel, the protective ESD bag and the outside surface of the box.

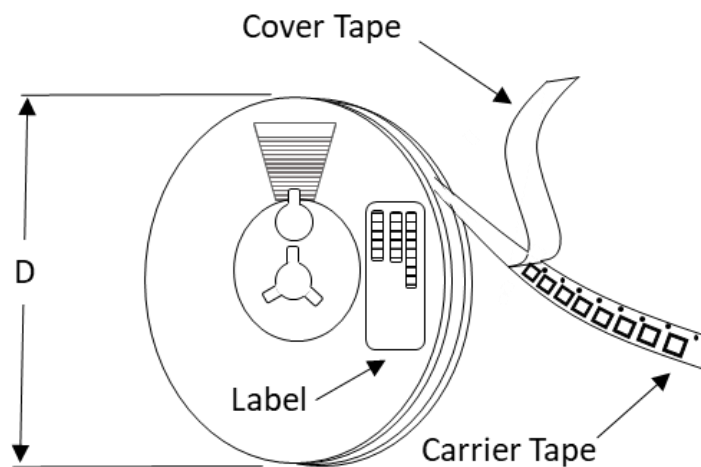

Tape and Reel Packaging with Reel Diameter Noted (D)

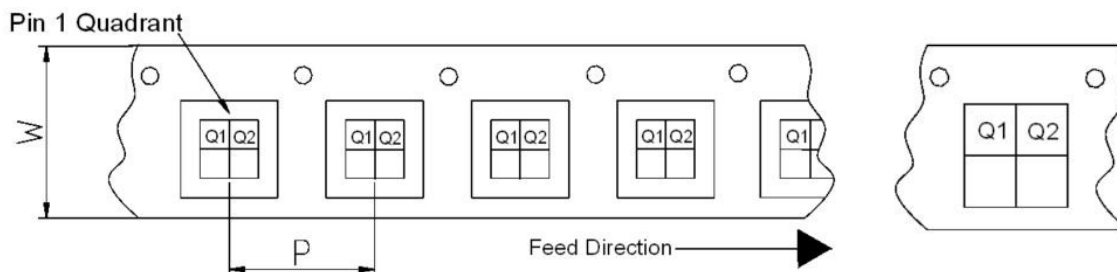

Carrier Tape Width (W), Pitch (P), Feed Direction and Pin 1 Quadrant Information



Preliminary

# GRF5504

High Efficiency, 3.5 Watt PA  
Tuning Range: 0.4 to 0.5 GHz

Tape and Reel Specification and Device Package Information Table

Package				Carrier Tape			Reel	
Type	Dimensions (mm)	Leads	Weight (mg)	Width (W) (mm)	Pocket Pitch (P) (mm)	Pin 1 Quadrant	Diameter (D) (inches)	Units per Reel
QFN	2.0 x 2.0 x 0.50	12	7	8	4	Q1	7	2500
QFN	3.0 x 3.0 x 0.85	16	24	12	8	Q1	7	1500
DFN	1.5 x 1.5 x 0.45	6	4	8	4	Q1	7	2500
DFN	2.0 x 2.0 x 0.75	8	12	8	4	Q1	7	2500
LFM	3.5 x 3.5 x 0.75	See	TBD	12	8	Q2	7	1500
LFM	4.0 x 4.0 x 0.75	See note	TBD	12	8	Q2	7	1500

Note: Lead count may vary. Reference applicable product data sheet



*Preliminary*

# GRF5504

**High Efficiency, 3.5 Watt PA  
Tuning Range: 0.4 to 0.5 GHz**

Data Sheet Release Status:	Notes
Advance	S-parameter and NF data based on EM simulations for the fully packaged device using foundry supplied transistor s-parameters. Linearity estimates based on device size, bias condition and experience with related devices.
Preliminary	All data based on evaluation board measurements in the Guerrilla RF Applications Lab.
Released	All data based on device qualification data. Typically, this data is nearly identical to the data found in the preliminary version. Max and min values for key RF parameters are included.

Information in this datasheet is specific to the Guerrilla RF, Inc. ("Guerrilla RF") product identified.

This datasheet, including the information contained in it, is provided by Guerrilla RF as a service to its customers and may be used for informational purposes only by the customer. Guerrilla RF assumes no responsibility for errors or omissions on this datasheet or the information contained herein. Information provided is believed to be accurate and reliable, however, no responsibility is assumed by Guerrilla RF for its use, nor for any infringement of patents, or other rights of third parties, resulting from its use. Guerrilla RF assumes no liability for any datasheet, datasheet information, materials, products, product information, or other information provided hereunder, including the sale, distribution, reproduction or use of Guerrilla RF products, information or materials.

No license, whether express, implied, by estoppel, by implication or otherwise is granted by this datasheet for any intellectual property of Guerrilla RF, or any third party, including without limitation, patents, patent rights, copyrights, trademarks and trade secrets. All rights are reserved by Guerrilla RF.

All information herein, products, product information, datasheets, and datasheet information are subject to change and availability without notice. Guerrilla RF reserves the right to change component circuitry, recommended application circuitry and specifications at any time without prior notice. Guerrilla RF may further change its datasheet, product information, documentation, products, services, specifications or product descriptions at any time, without notice. Guerrilla RF makes no commitment to update any materials or information and shall have no responsibility whatsoever for conflicts, incompatibilities, or other difficulties arising from any future changes.

GUERRILLA RF INFORMATION, PRODUCTS, PRODUCT INFORMATION, DATASHEETS AND DATASHEET INFORMATION ARE PROVIDED "AS IS" AND WITHOUT WARRANTY OF ANY KIND, WHETHER EXPRESS, IMPLIED, STATUTORY, OR OTHERWISE, INCLUDING FITNESS FOR A PARTICULAR PURPOSE OR USE, MERCHANTABILITY, PERFORMANCE, QUALITY OR NON-INFRINGEMENT OF ANY INTELLECTUAL PROPERTY RIGHT; ALL SUCH WARRANTIES ARE HEREBY EXPRESSLY DISCLAIMED. GUERRILLA RF DOES NOT WARRANT THE ACCURACY OR COMPLETENESS OF THE INFORMATION, TEXT, GRAPHICS OR OTHER ITEMS CONTAINED WITHIN THESE MATERIALS. GUERRILLA RF SHALL NOT BE LIABLE FOR ANY DAMAGES, INCLUDING BUT NOT LIMITED TO ANY SPECIAL, INDIRECT, INCIDENTAL, STATUTORY, OR CONSEQUENTIAL DAMAGES, INCLUDING WITHOUT LIMITATION, LOST REVENUES OR LOST PROFITS THAT MAY RESULT FROM THE USE OF THE MATERIALS OR INFORMATION, WHETHER OR NOT THE RECIPIENT OF MATERIALS HAS BEEN ADVISED OF THE POSSIBILITY OF SUCH DAMAGE.

Customers are solely responsible for their use of Guerrilla RF products in the Customer's products and applications or in ways which deviate from Guerrilla RF's published specifications, either intentionally or as a result of design defects, errors, or operation of products outside of published parameters or design specifications. Customers should include design and operating safeguards to minimize these and other risks. Guerrilla RF assumes no liability or responsibility for applications assistance, customer product design, or damage to any equipment resulting from the use of Guerrilla RF products outside of stated published specifications or parameters.



## X-ON Electronics

Largest Supplier of Electrical and Electronic Components

*Click to view similar products for [RF Amplifier](#) category:*

*Click to view products by [Guerrilla RF](#) manufacturer:*

Other Similar products are found below :

[A82-1](#) [BGA622H6820XTSA1](#) [BGA 728L7 E6327](#) [BGB719N7ESDE6327XTMA1](#) [HMC397-SX](#) [HMC405](#) [HMC561-SX](#) [HMC8120-SX](#)  
[HMC8121-SX](#) [HMC-ALH382-SX](#) [HMC-ALH476-SX](#) [SE2433T-R](#) [SMA3101-TL-E](#) [SMA39](#) [A66-1](#) [A66-3](#) [A67-1](#) [A81-2](#) [LX5535LQ](#)  
[LX5540LL](#) [MAAM02350](#) [HMC3653LP3BETR](#) [HMC549MS8GETR](#) [HMC-ALH435-SX](#) [SMA101](#) [SMA32](#) [SMA411](#) [SMA531](#)  
[SST12LP19E-QX6E](#) [WPM0510A](#) [HMC5929LS6TR](#) [HMC5879LS7TR](#) [HMC1087F10](#) [HMC1086](#) [HMC1016](#) [SMA1212](#) [MAX2689EWS+T](#)  
[MAAMSS0041TR](#) [MAAM37000-A1G](#) [LTC6430AIUF-15#PBF](#) [SMA70-2](#) [SMA4011](#) [A231](#) [HMC-AUH232](#) [LX5511LQ](#) [LX5511LQ-TR](#)  
[HMC7441-SX](#) [HMC-ALH310](#) [XD1001-BD-000V](#) [A4011](#)