



PSU-Series

Programmable Switching D.C. Power Supply

FEATURES

- Voltage Output : 6V/12.5V/20V/40V/60V/100V/150V/300V/400V/600V
- Power Output : 1200W ~ 1560W
- C.V/C.C Priority Mode
- Adjustable Voltage/Current Rise and Fall Time
- Series/Parallel Connection : Max. 2 units(Models Under 300V)/4 units of The Same Model
- High Efficiency and High Power Density
- 1U Height and 19" Rack Mount Size
- Three sets of Preset Function
- Bleeder Control Function
- Internal Resistance Function
- Panel Lock Function
- Protection : OVP, OCP, OHP, UVL, AC Fail, FAN Fail
- Standard : USB, LAN, RS-232, RS-485, Analog Control
- Option : GPIB, Isolated Analog Interface(Voltage Control/Current Control)

GW INSTEK
Simply Reliable

GW Instek PSU-HV series has five models, including PSU 100-15, PSU 150-10, PSU 300-5, PSU 400-3.8, and PSU 600-2.6. The launch of PSU-HV is to complete the existing PSU-series so as to satisfy high voltage application demands, allowing the augmented PSU-series to cover a voltage range from 6V to 600V. PSU-HV inherits the functional design and maintains the high power density characteristic and 1U height appearance of the PSU-LV series (PSU 6-200, PSU 12.5-120, PSU 20-76, PSU 40-38 and PSU 60-25). Furthermore, the original maximum output voltage of 60V is expanded to the maximum voltage of 600V and the maximum power of 1560 watts. The launch of the PSU-HV series augments the existing PSU-series to fully satisfy the extensive voltage demands of 1U power supply market and provides system integrators with more flexibilities and selections to conduct system integration. The introduction of the PSU-HV series has perfected the PSU product line, which satisfies the application requirements ranging from low voltage and large current to high voltage.

Utilizing same model units of the PSU-series to conduct series and parallel connections can increase total output power, total current or total voltage. The wide voltage and current output ranges of the PSU-series can fully satisfy various voltage and current measurement requirements. The PSU-series is a single power output DC programmable power supply, which outputs 1200W to 1560W. The PSU-series provides maximum 2 units in series connection (models under 300V) to achieve maximum 600V or 4 units in parallel connection to obtain maximum 800A and the maximum output power of 6.24 kilowatts.

The PSU-series allows settings for CC priority or CV priority. Under CC or CV mode, users can adjust slew rate for output voltage or current based upon test requirements. There are two kinds of slew rate settings: high speed priority and slew rate priority. High speed priority sets slew rate at the maximum speed to reach CC or CV mode. Slew rate priority allows users to set slew rate for CC or CV mode in order to control rise or fall slew rate. Slew rate priority mode is ideal for motor tests by adjusting the rise time of output voltage to protect DUT from being damaged by inrush current occurred at turn-on.

Comparing with other 1U power supplies available in the market, PSU supports a most complete array of interfaces, including USB, LAN, RS-232, RS-485, analog control interface, GPIB (option), isolated analog interface (voltage control), and isolated analog interface (current control). Via the multi-drop mode, PSU will not need any switch/hub and GPIB cable for remote control and slave unit augmentation when using LAN, USB or GPIB. This feature can help users save costs on augmentation equipment for connecting slave while using LAN or USB.

The new PSU-HV series is ideal for the primary input of DC/DC converter and servomotor production application. PSU is often integrated into component test systems such as aging test equipment for capacitors; 600V DC bias applications; aging test equipment for diode; semiconductor production equipment; automotive electronics; and ECU for V8 engine or V12 engine, etc.

The PSU-series provides users with flexible settings of High/Low Level or Trigger input /Trigger output signals with pulse width of 1 ~ 60ms. Trigger input controls PSU to output or upload preset voltage, current and memory parameters. While outputting or uploading preset voltage, current and memory parameters PSU can produce corresponding Trigger output signals.

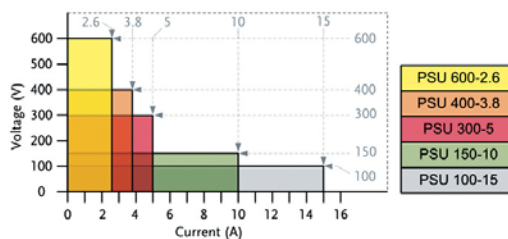
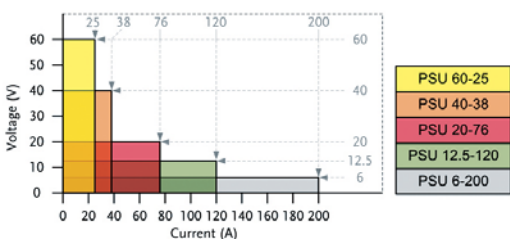

Model name	Voltage Rating ¹	Current Rating ²	Power
PSU 6-200	6V	200A	1200W
PSU 12.5-120	12.5V	120A	1500W
PSU 20-76	20V	76A	1520W
PSU 40-38	40V	38A	1520W
PSU 60-25	60V	25A	1500W
PSU 100-15	100V	15A	1500W
PSU 150-10	150V	10A	1500W
PSU 300-5	300V	5A	1500W
PSU 400-3.8	400V	3.8A	1520W
PSU 600-2.6	600V	2.6A	1560W

A. SERIES/PARALLEL OPERATION AND HIGH POWER DENSITY

Series Connection	1 unit	2 units	Parallel connection	1 unit	2 units	3 units	4 units
Height of Sets	1U	2U	Height of Sets	1U	2U	3U	4U
PSU 6-200	6V 200A	12V 200A	PSU 6-200	6V 200A	6V 400A	6V 600A	6V 800A
PSU 12.5-120	12.5V 120A	25V 120A	PSU 12.5-120	12.5V 120A	12.5V 240A	12.5V 360A	12.5V 480A
PSU 20-76	20V 76A	40V 76A	PSU 20-76	20V 76A	20V 152A	20V 228A	20V 304A
PSU 40-38	40V 38A	80V 38A	PSU 40-38	40V 38A	40V 76A	40V 114A	40V 152A
PSU 60-25	60V 25A	120V 25A	PSU 60-25	60V 25A	60V 50A	60V 75A	60V 100A
PSU 100-15	100V 15A	200V 15A	PSU 100-15	100V 15A	100V 30A	100V 45A	100V 60A
PSU 150-10	150V 10A	300V 10A	PSU 150-10	150V 10A	150V 20A	150V 30A	150V 40A
PSU 300-5	300V 5A	600V 5A	PSU 300-5	300V 5A	300V 10A	300V 15A	300V 20A
PSU 400-3.8	400V 3.8A	NA	PSU 400-3.8	400V 3.8A	400V 7.6A	400V 11.4A	400V 15.2A
PSU 600-2.6	600V 2.6A	NA	PSU 600-2.6	600V 2.6A	600V 5.2A	600V 7.8A	600V 10.4A

Remark : 1U → 43.6mm

To augment output power, the PSU-series can realize two-fold rated power (models under 300V) via 2 same model units in series connection; and four-fold rated power via 4 same model units in parallel connection so as to satisfy customers with large voltage and large current requirements. 2U height units in series connection can achieve maximum 600V output. 4U height units in parallel connection can output maximum 800A and 6240W.

B. REMOTE PROGRAM CONTROL (UP TO 31 UNITS CONNECTION)

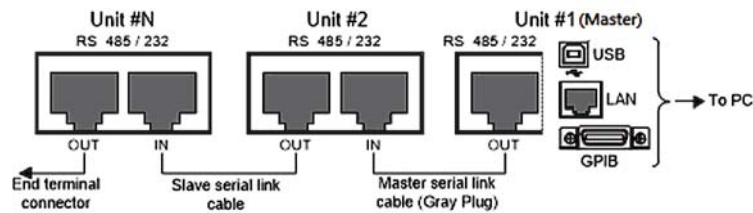

Provide RS-232, RS-485, USB, GPIB and LAN for PC to remote control Master PSU-Series. RJ-45 connector on the rear panel can connect up to 31 units.

* For the detailed information please refer to User Manual

LAN or USB remote control and augmenting slave units by using PSU-Series multi-drop mode will no longer need any switch/hub that can help customers save equipment costs.

C. C.V/C.C PRIORITY MODE

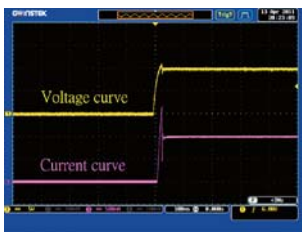

Under the conventional C.V mode, inrush current and surge voltage appeared at forward voltage (V_f) of LED.

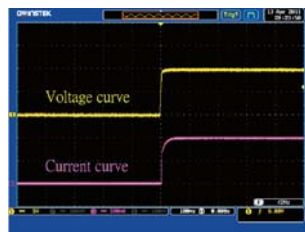

Under C.C priority mode, inrush and surge voltage are effectively restrained.

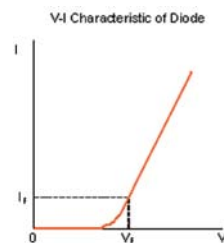

V-I Characteristic of Diode

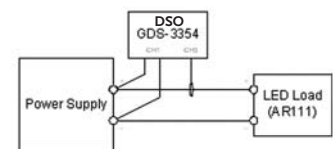

Using GDS-3354 DSO to Test LED Operation Under C.V Priority and C.C Priority Respectively

Conventional power supplies under the CV priority mode will produce inrush current and surge voltage at turn-on. The PSU-series has CV and CC priority modes.

The CC priority mode can prevent inrush current and surge voltage from occurring at turn-on to protect DUT.

D. ADJUSTABLE SLEW RATE

VOLTAGE SLEW RATE	CURRENT SLEW RATE
0.001V~0.06V/msec (PSU 6-200)	0.001A~2A/msec (PSU 6-200)
0.001V~0.125V/msec (PSU 12.5-120)	0.001A~1.2A/msec (PSU 12.5-120)
0.001V~0.2V/msec (PSU 20-76)	0.001A~0.76A/msec (PSU 20-76)
0.001V~0.4V/msec (PSU 40-38)	0.001A~0.38A/msec (PSU 40-38)
0.001V~0.6V/msec (PSU 60-25)	0.001A~0.25A/msec (PSU 60-25)
0.001V~1.000V/msec (PSU 100-15)	0.001A~0.150A/msec (PSU 100-15)
0.001V~1.500V/msec (PSU 150-10)	0.001A~0.100A/msec (PSU 150-10)
0.001V~1.500V/msec (PSU 300-5)	0.001A~0.025A/msec (PSU 300-5)
0.001V~2.000V/msec (PSU 400-3.8)	0.001A~0.008A/msec (PSU 400-3.8)
0.001V~2.400V/msec (PSU 600-2.6)	0.001A~0.006A/msec (PSU 600-2.6)

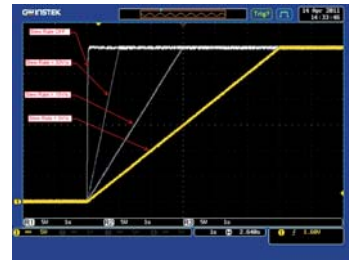

Adjustable Voltage Slew Rate

The PSU series can adjust slew rate for current and voltage. Via setting the rise and fall time of voltage and current, users can verify DUT's characteristics during voltage and current variation. Additionally, slew rate adjustment can mitigate voltage shift to effectively prevent DUT from being damaged by inrush current. This function is ideal for tests such as capacitive load and motor.

E. OVP, OCP AND UVL

PSU-Series	OCP	OVP	UVL
6-200	5 ~ 220	0.6 ~ 6.6	0 ~ 6.3
12.5-120	5 ~ 132	1.25 ~ 13.75	0 ~ 13.12
20-76	5 ~ 83.6	2 ~ 22	0 ~ 21
40-38	3.8 ~ 41.8	4 ~ 44	0 ~ 42
60-25	2.5 ~ 27.5	5 ~ 66	0 ~ 63
100-15	1.5 ~ 16.5	5 ~ 110	0 ~ 105
150-10	1 ~ 11	5 ~ 165	0 ~ 157.5
300-5	0.5 ~ 5.5	5 ~ 330	0 ~ 315
400-3.8	0.38 ~ 4.18	5 ~ 440	0 ~ 420
600-2.6	0.26 ~ 2.86	5 ~ 660	0 ~ 630

Once the voltage or current output exceeds the preset level of OVP or OCP, PSU will shut down output to protect DUT. UVL is for users to set the minimum output voltage from the output terminal.

F. TRIGGER CONTROL (TRIGGER INPUT/TRIGGER OUTPUT)

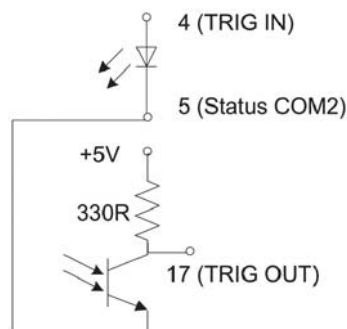

PSU-series provides users with complete trigger input and trigger output functions so as to flexibly control PSU-series. Each function is elaborated as follows.

Trigger Input function :

1. Allow users to set the effective pulse width from 0~60ms for trigger input (0: the LOW or HIGH signal of DC level for trigger input)
2. Receive trigger input to control PSU-series output or to output preset voltage and current.
3. Receive trigger input to upload preset memory parameters.

Trigger Output function :

1. Allow users to set the effective pulse width from 0~60ms for trigger output (0: the LOW or HIGH signal of DC level for trigger output)
2. Set LOW or HIGH for output DC level
3. PSU produces trigger output signal when setting output or changing preset value or uploading preset memory parameters.

G. EXTERNAL ANALOG CONTROL FUNCTION

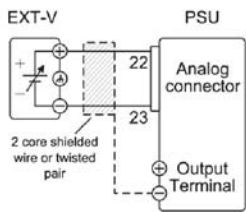

- Pin23 → EXT-V (-)
- Pin22 → EXT-V (+)
- Wire shield → negative (-) output terminal

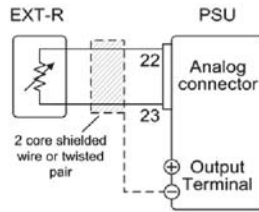

- Pin22 → EXT-R
- Pin23 → EXT-R
- Wire shield → negative (-) output terminal

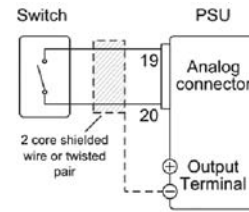

- Pin19 → Switch
- Pin20 → Switch
- Wire shield → negative (-) output terminal

External Voltage Controls Voltage Range

External Resistance Controls Voltage Range

External On-off to Control Output, on or off

The rear panel of the PSU-series has an analog control terminal. The external analog control interface allows external voltage or resistance to control voltage and current output; and allows power supply to output or to be turned on and off. The diagram on the upper shows typical connection methods for external control applications. For more detailed connection information please refers to user manual.

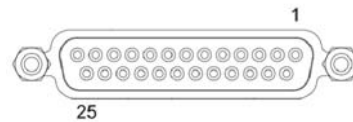

H. BLEEDER CONTROL

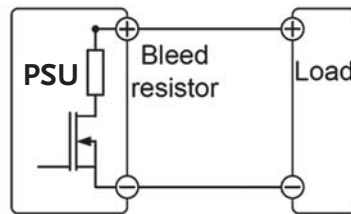

PSU-Series Built-in Bleed Resistor

The PSU-Series employs a bleed resistor in parallel with the output terminal. Bleed resistor is designed to dispatch the power from the power supply filter capacitors when power is turned off or the load is disconnected. Without a bleed resistor, power terminal may remain charged on the filter capacitors

for some time and be potentially hazardous. In addition, bleed resistor also allows for smoother voltage regulation of the power supply as the bleed resistor acts as a minimum voltage load. The bleed resistance can be turned on or off using the configuration setting.

I. VARIOUS INTERFACES SUPPORT

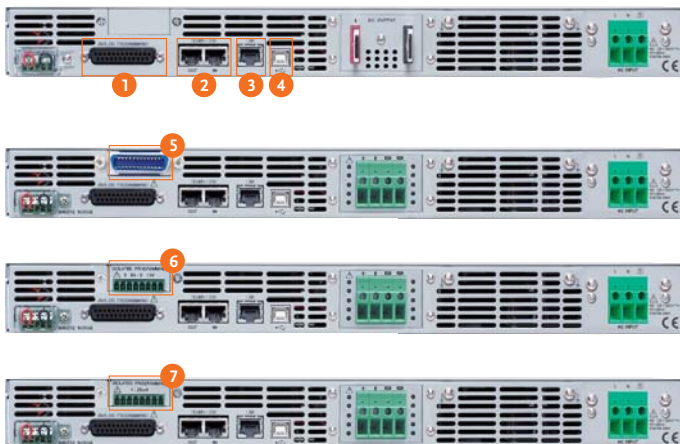

1. Analog Control Interface
2. RS485/RS232 Interface for Remote Control
3. LAN Port for System Communication
4. USB Interface for Remote Control
5. GPIB Interface for Remote Control
6. Isolate Voltage Remote Control Card
7. Isolate Current Remote Control Card

J.

USING THE RACK MOUNT KIT



Rack Mount Kit for PSU-Series EIA & JIS

The rack mount kit of the PSU-Series supports both EIA and JIS standards. A standard rack can accommodate one unit of the PSU-Series.

K.

OUTPUT ON / OFF DELAY

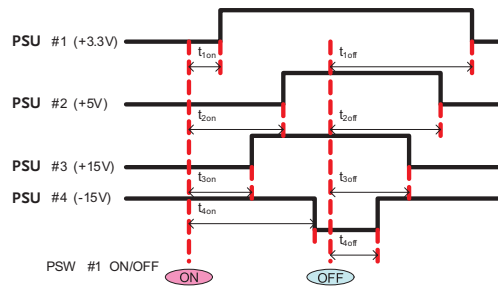

The Example of Output On/Off Delay Control Among Multiple Outputs of the PSU Units

The Output On/Off delay feature enables the setting of a specific time delay for output on after the power supply output is turned on, and a specific time delay for output off after the power supply output is turned off. When multiple PSU units are used, the On/Off

delay time of each unit can be set respectively referring to fix time points. This multiple-output control can be done through the analog control terminal at rear panel or through the PC programming with standard commands.

OPTIONAL ASSESSORIES

PSU-01B

Bus bar for 2 units in parallel connection

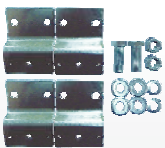

PSU-232

Rs232 Cable with DB9 connector kit



PSU-02C

Cable for 3 units in parallel connection



GPW-001

UL/CSA power cord 3m, PSU option



PSU-01A

Joins a vertical stack of 2 PSU units together. 2U-sized handles x2, joining plates x2



PSU-01C

Cable for 2 units in parallel connection



PSU-485

Rs485 Cable with DB9 connector kit



PSU-03B

Bus bar for 4 units in parallel connection

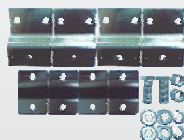

GPW-002

VDE power cord 3m, PSU option



PSU-02A

Joins a vertical stack of 3 PSU units together. 3U-sized handles x2, joining plates x2



PSU-02B

Bus bar for 3 units in parallel connection



GRM-001

Slide bracket 2pcs/set, PSU option



PSU-03C

Cable for 4 units in parallel connection



GPW-003

PSE power cord 3m, PSU option



PSU-03A

Joins a vertical stack of 4 PSU units together. 4U-sized handles x2, joining plates x2



PANEL INTRODUCTION



- | | | |
|---------------------------------------|------------------------------|---|
| 1. AC Power Switch (AC Power On/Off) | 7. DC Output Terminal | 12. Option Slot for (Selection One of Three)
GPIB Interface Card/Isolate Voltage Remote
Control Card/Isolate Current Remote
Control Card |
| 2. USB A Port | 8. USB | |
| 3. Voltage Knob | 9. LAN | |
| 4. Display Area | 10. RS 485/RS 232 | |
| 5. Current Knob | 11. Analog Control Interface | 13. Remote Sense |
| 6. AC Input (HV:Wire Clamp Connector) | | |

SPECIFICATIONS

MODEL	PSU 6-200	PSU 12.5-120	PSU 20-76	PSU 40-38	PSU 60-25	PSU 100-15	PSU 150-10	PSU 300-5	PSU 400-3.8	PSU 600-2.6
OUTPUT RATINGS										
Rated Output Voltage (*1)	6V	12.5V	20V	40V	60V	100V	150V	300V	400V	600V
Rated Output Current (*2)	200A	120A	76A	38A	25A	15A	10A	5A	3.8A	2.6A
Rated Output Power	1200W	1500W	1520W	1520W	1500W	1500W	1500W	1500W	1520W	1560W
RIPPLE AND NOISE(*5)										
CVp-p(10 ~ 20MHz) p-p (*6)	60mV	60mV	60mV	60mV	60mV	80mV	100mV	150mV	200mV	300mV
CVrms(5Hz ~ 1MHz) r.m.s. (*7)	8mV	8mV	8mV	8mV	8mV	8mV	10mV	25mV	40mV	60mV
CCrms(5Hz ~ 1MHz) r.m.s. (*12)	400mA	240mA	152mA	95mA	75mA	45mA	35mA	25mA	17mA	12mA
LOAD REGULATION										
Voltage(*4)	2.6mV	3.25mV	4mV	6mV	8mV	12mV	17mV	32mV	42mV	62mV
Current(*11)	45mA	29mA	20.2mA	12.6mA	10mA	8mA	7mA	6mA	5.76mA	5.52mA
LINE REGULATION										
Voltage(*3)	2.6mV	3.25mV	4mV	6mV	8mV	12mV	17mV	32mV	42mV	62mV
Current(*3)	22mA	14mA	9.6mA	5.8mA	4.5mA	3.5mA	3mA	2.5mA	2.38mA	2.26mA
ANALOG PROGRAMMING AND MONITORING										
External Voltage Control Output Voltage	Accuracy and linearity: $\pm 0.5\%$ of rated output voltage									
External Voltage Control Output Current	Accuracy and linearity: $\pm 1\%$ of rated output current									
External Resistor Control Output Voltage	Accuracy and linearity: $\pm 1\%$ of rated output voltage									
External Resistor Control Output Current	Accuracy and linearity: $\pm 1.5\%$ of rated output current									
Output Voltage Monitor	Accuracy: $\pm 1\%$									
Output Current Monitor	Accuracy: $\pm 1\%$									
Shutdown Control	Turns the output off with a LOW (0V to 0.5V) or short-circuit									
Output On/Off Control	Possible logic selections: Turn the output on using a LOW (0V to 0.5V) or short-circuit, turn the output off using a HIGH (4.5V to 5V) or open-circuit; Turn the output on using a HIGH (4.5V to 5V) or open-circuit, turn the output off using a LOW (0V to 0.5V) or short-circuit									
Alarm Clear Control	Clear alarms with a LOW (0V to 0.5V) or short-circuit									
CV/CC/ALM/PWR ON/OUT ON Indicator	Photocoupler open collector output; Maximum voltage 30V, maximum sink current 8mA									
Trigger Out	Maximum low level output = 0.8V; minimum high level output = 2V; Maximum source current = 8mA									
Trigger In	Maximum low level input voltage = 0.8V; minimum high level input voltage = 2V, Maximum sink current = 8mA									
FRONT PANEL										
Display, 4 digits, Voltage Accuracy 0.1%+ Current Accuracy 0.2%+	12mV 600mA	25mV 360mA	40mV 228mA	80mV 114mA	120mV 75mA	200mV 45mA	300mV 30mA	600mV 15mA	800mV 11.4mA	1200mV 7.8mA
Indications	GREEN LED's: CV, CC, V, A, VSR, ISR, DLY, RMT, LAN, M1, M2, M3, RUN, Output ON; RED LED's: ALM, ERR									
Buttons	Lock/Local(Unlock), PROT(ALM_CLR), Function(M1), Test(M2), Set(M3), Shift, Output									
Knobs	Voltage, Current									
USB Port	Type A USB connector									

SPECIFICATIONS

SPECIFICATIONS											
MODEL	PSU 6-200	PSU 12.5-120	PSU 20-76	PSU 40-38	PSU 60-25	PSU 100-15	PSU 150-10	PSU 300-5	PSU 400-3.8	PSU 600-2.6	
TRANSIENT RESPONSE TIME (*10)											
Transient Response Time	1.5ms	1ms	1ms	1ms	1ms	1ms	2ms	2ms	2ms	2ms	
OUTPUT RESPONSE TIME											
Rise Time(*8)	Rated load 80ms	80ms	80ms	80ms	80ms	150ms	150ms	150ms	200ms	250ms	
	No load	80ms	80ms	80ms	80ms	80ms	150ms	150ms	200ms	250ms	
Fall Time(*9)	Rated load 10ms	50ms	50ms	80ms	80ms	150ms	150ms	150ms	200ms	250ms	
	No load	50ms	700ms	800ms	1000ms	1100ms	1500ms	2000ms	2500ms	3000ms	
PROGRAMMING AND MEASUREMENTS (RS-232/485, USB, LAN, GPIB)											
Output Voltage Programming Accuracy	0.05%+	3mV	6.25mV	10mV	20mV	30mV	50mV	75mV	150mV	200mV	300mV
Output Current Programming Accuracy	0.2%+	200mA	120mA	76mA	38mA	25mA	15mA	10mA	5mA	3.8mA	2.6mA
Output Voltage Programming Resolution		0.2mV	0.4mV	0.7mV	1.3mV	2mV	3.4mV	5.2mV	10.2mV	13.6mV	20.4mV
Output Current Programming Resolution		6mA	4mA	2.5mA	1.2mA	0.8mA	0.5mA	0.34mA	0.19mA	0.13mA	0.09mA
Output Voltage Measurement Accuracy	0.1%+	6mV	12.5mV	20mV	40mV	60mV	100mV	150mV	300mV	400mV	600mV
Output Current Measurement Accuracy	0.2%+	400mA	240mA	152mA	76mA	50mA	30mA	20mA	10mA	7.6mA	5.2mA
Output Voltage Measurement Resolution		0.2mV	0.4mV	0.7mV	1.3mV	2mV	3.4mV	5.2mV	10.2mV	13.6mV	20.4mV
Output Current Measurement Resolution		6mA	4mA	2.5mA	1.2mA	0.8mA	0.5mA	0.34mA	0.19mA	0.13mA	0.09mA
TEMPERATURE COEFFICIENT											
Voltage & Current	100ppm/°C after a 30 minute warm-up										
REMOTE SENSE COMPENSATION VOLTAGE(SINGLE WIRE)											
Voltage	1V	1V	1V	2V	3V	5V	5V	5V	5V	5V	
PROTECTION FUNCTION											
Over Voltage Protection(OVP)	Setting Range	0.6~6.6V	1.25~13.75V	2~22V	4~44V	5~66V	5~110V	5~165V	5~330V	5~440V	5~660V
	Setting Accuracy	60mV	125mV	200mV	400mV	600mV	1000mV	1500mV	3000mV	4000mV	6000mV
Over Current Protection(OCP)	Setting Range	5~220A	5~132A	5~83.6A	3.8~41.8A	2.5~27.5A	1.5~16.5A	1~11A	0.5~5.5A	0.38~4.18A	0.26~2.86A
	Setting Accuracy	4000mA	2400mA	1520mA	760mA	500mA	300mA	200mA	100mA	76mA	52mA
Under Voltage Limit(UVL)	Setting Range	0~6.3V	0~13.12V	0~21V	0~42V	0~63V	0~105V	0~157.5V	0~315V	0~420V	0~630V
Over Temperature Protection(OHP)	Operation	Turn the output off.									
Incorrect Sensing Connection Protection(SENSE)	Operation	Turn the output off.									
Low AC Input Protection (AC-FAIL)	Operation	Turn the output off.									
Shutdown (SD)	Operation	Turn the output off.									
Power Limit (POWER LIMIT)	Operation	Over power limit									
	Value (Fixed)	Approx. 105% of rated output power									
INTERFACE CAPABILITIES											
USB	TypeA: Host, TypeB: Slave, Speed: 1.1/2.0, USB Class: CDC(Communications Device Class)										
LAN	MAC Address, DNS IP Address, User Password, Gateway IP Address, Instrument IP Address, Subnet Mask										
RS-232 / RS-485	Complies with the EIA232D / EIA485 Specifications										
GPIB (Factory Option)	SCPI - 1993, IEEE 488.2 compliant interface										
ISOLATED ANALOG CONTROL INTERFACE (FACTORY OPTION)											
Voltage Control	Using 0-5V or 0-10V signals for programming and measurement										
Current Control	Using 4-20mA current signals for programming and measurement										
ENVIRONMENTAL CONDITIONS											
Operating Temperature	0 °C ~ 50 °C										
Storage Temperature	-25 °C ~ 70 °C										
Operating Humidity	20% ~ 85% RH; No condensation										
Storage Humidity	90% RH or less; No condensation										
Altitude	Maximum 2000m										
INPUT CHARACTERISTICS											
Nominal Input Rating	100Vac to 240Vac, 50Hz to 60Hz, single phase										
Input Voltage Range	85Vac ~ 265Vac										
Input Frequency Range	47Hz ~ 63Hz										
Maximum Input Current	100Vac/200Vac(A)	21/11									
Inrush Current	Less than 50A										
Maximum Input Power	2000VA										
Power Factor	100Vac/200Vac	0.99/0.98									
Hold-up Time	20ms or greater										
Efficiency (*13)	100Vac/200Vac(%)	76.5/78.5	82.0/85.0	83.0/86.0	84.0/87.0	84.0/87.0	84.0/87.0	84.0/87.0	84.0/87.0	84.0/87.0	
DIMENSIONS & WEIGHT											
	423(W) × 43.6(H) × 447.2(D)mm, Approx. 8.7kg										

Note : *1. Minimum voltage is guaranteed to maximum 0.2% of the rated output voltage. *8. From 10%~90% of rated output voltage, with rated resistive load. *12. For 6V model the ripple is measured at 2~6V output voltage and full output current. For other models, the ripple is measured at 10~100% output voltage and full output current.

*2. Minimum current is guaranteed to maximum 0.4% of the rated output current. *9. From 90%~10% of rated output voltage, with rated resistive load. *13. At rated output power.

*3. At 85~132Vac or 170~265Vac, constant load. *10. Time for output voltage to recover within 0.5% of its rated output for a load change from 10~90% of its rated output current. Voltage set point from 10%~100% of rated output.

*4. From No-load to Full-load, constant input voltage. *11. For load voltage change, equal to the unit voltage rating, constant input voltage.

*5. Measured at the sensing point in Remote Sense. *6. Measurement frequency bandwidth is 10Hz~20MHz. *7. Measurement frequency bandwidth is 5Hz~1MHz.

Specifications subject to change without notice. SU-SeriesGD1BH

ORDERING INFORMATION

PSU 6-200	1200W Programmable Switching DC Power Supply
PSU 12.5-120	1500W Programmable Switching DC Power Supply
PSU 20-76	1520W Programmable Switching DC Power Supply
PSU 40-38	1520W Programmable Switching DC Power Supply
PSU 60-25	1500W Programmable Switching DC Power Supply
PSU 100-15	1500W Programmable Switching DC Power Supply
PSU 150-10	1500W Programmable Switching DC Power Supply
PSU 300-5	1500W Programmable Switching DC Power Supply
PSU 400-3.8	1520W Programmable Switching DC Power Supply
PSU 600-2.6	1560W Programmable Switching DC Power Supply

ACCESSORIES

CD-ROM x 1 (User Manual, Programming Manual), Output terminal cover x 1, Analog connector plug kit x 1, Output terminal M8 bolt set (6V~60V model), Input terminal cover x 1, 1U Handle (RoHS), 1U Bracket (LEFT, RoHS), 1U Bracket (RIGHT, RoHS), Power Cord (10A) provided for certain regions only

OPTIONAL ACCESSORIES

PSU-01B	Bus bar for 2 units in parallel connection	GTL-246	USB Cable, USB 2.0A-B Type Cable, 4P
PSU-01C	Cable for 2 units in parallel connection	GRM-001	Slide bracket 2pcs/set ,PSU option
PSU-02B	Bus bar for 3 units in parallel connection	PSU-GPIB	GPIB Interface card (factory option)
PSU-02C	Cable for 3 units in parallel connection	GPW-001	UL/CSA power cord 3m ,PSU option
PSU-03B	Bus bar for 4 units in parallel connection	GPW-002	VDE power cord 3m ,PSU option
PSU-03C	Cable for 4 units in parallel connection	GPW-003	PSE power cord 3m ,PSU option

PSU-232 RS232 Cable with DB9 connector kit
 PSU-485 RS485 Cable with DB9 connector kit
 PSU-01A Joins a vertical stack of 2 PSU units together. 2U-sized handles x2, joining plates x2
 PSU-02A Joins a vertical stack of 3 PSU units together. 3U-sized handles x2, joining plates x2
 PSU-03A Joins a vertical stack of 4 PSU units together. 4U-sized handles x2, joining plates x2
 PSU-ISO-I Isolate current remote control card (factory option)
 PSU-ISO-V Isolate voltage remote control card (factory option)

FREE DOWNLOAD

Driver LabView Driver

Global Headquarters

GOOD WILL INSTRUMENT CO., LTD.

No.7-1, Jhongsing Road, Tucheng Dist., New Taipei City 236, Taiwan

T +886-2-2268-0389 F +886-2-2268-0639

E-mail: marketing@goodwill.com.tw



www.gwinstek.com



www.facebook.com/GWInstek

GW INSTEK

Simply Reliable

X-ON Electronics

Largest Supplier of Electrical and Electronic Components

Click to view similar products for [Benchtop Power Supplies](#) category:

Click to view products by [GW INSTEK](#) manufacturer:

Other Similar products are found below :

[NL200](#) [PR20](#) [ZUPNC403](#) [ZUP/W](#) [ZUPNC402](#) [TL89F2](#) [TL89K1](#) [TL89T1](#) [1332A-NIST](#) [ACC-GENH/RM](#) [P 6300](#) [SPE3102](#) [SPE3103](#)
[SPE6103](#) [P 5995](#) [CPX200DP](#) [AX-3003P](#) [AX-6003P](#) [AX-8450A](#) [TPM-3003](#) [HMP2020](#) [HMP2030](#) [HMP4040](#) [1350](#) [UT804](#) [1410](#) [XLNRC](#)
[1513](#) [1514](#) [1550](#) [1651A](#) [1652](#) [1665](#) [1666](#) [1667](#) [1693](#) [1694](#) [1698](#) [MX100TP](#) [1739](#) [1762](#) [1788](#) [TPM-3005](#) [1902B](#) [9174B](#) [GDM-8245](#)
[GDM-8255A](#) [GDM-8341](#) [PSP-603](#) [PSW 160-7.2](#)