

PART NO. : HFJ12-1G01ER-L12RL



1X2 FASTJACK™ WITH 1000BASE-T MAGNETICS

COMPLIANT TO IEEE802.3ab STANDARDS

RoHS COMPLIANT

COMPATIBLE TO LEAD-FREE WAVE SOLDERING PROCESS FOR THROUGH HOLE COMPONENTS

OPERATING TEMPERATURE 0/70°C

Housing Material: Polyester, Black UL94V-0
 Contacts: Phosphor Bronze 30µin Au plating over Ni
 Leads: Matte Sn over Ni plating
 Shield: Cu Alloy with Ni plating 40µin min
 Durability: 1000 mating cycles
 Dimensions: Inch [mm]
 Tolerances: ±0.008 inch if not specified

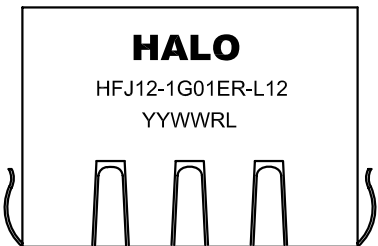

ELECTRICAL SPECIFICATIONS @25° C

URNS RATIO	1:1±3%
OCL (100KHz,0.1V,8mA)	350µH min
INSERTION LOSS 1-100MHz	-1.1dB max
RETURN LOSS 1-40MHz	-18dB min
60MHz	-14dB min
80MHz	-12dB min
100MHz	-10dB min
CROSSTALK 1-100MHz	-35dB typ
CMR 0.1-30MHz	-50dB typ
30-60MHz	-40dB typ
60-100MHz	-35dB typ
ISOLATION	1,500Vrms

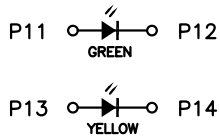
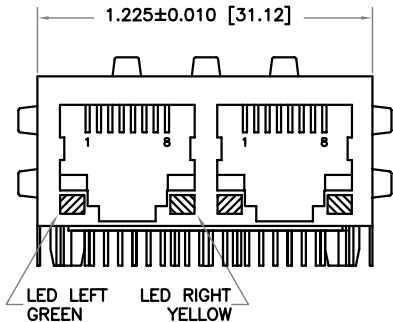
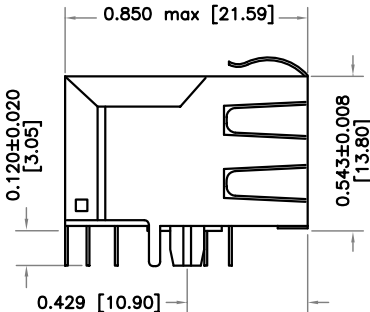

LED FORWARD VOLTAGE/
CURRENT: 2.1V/10mA typ

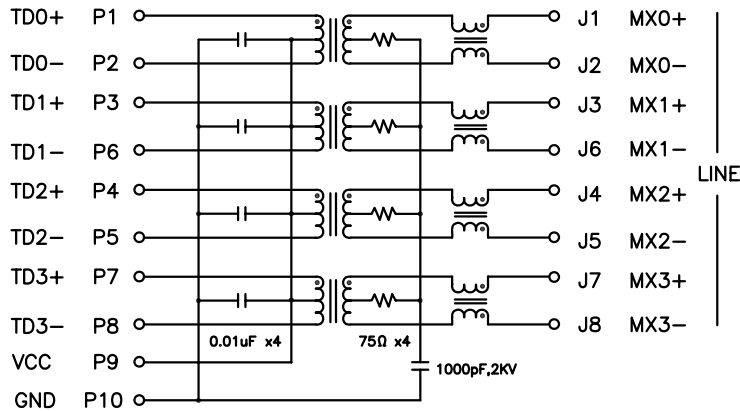

HALO/PBL

CALIFORNIA, USA
KOWLOON, HONG KONG
SINGAPORE

TITLE	FastJack™ 1x2	SIGNATURES	DATE	REV.	DESC.	DATE
FOR	GIGABIT ETHERNET	DRAWN	PETER LU	8/17/06	A	
PART NO.	HFJ12-1G01ER-L12RL	CHECKED				
SCALE	NONE	APPROVED				
PAGE	1 OF 2	FILE	HFJ121G01ER-L12RL.DWG			

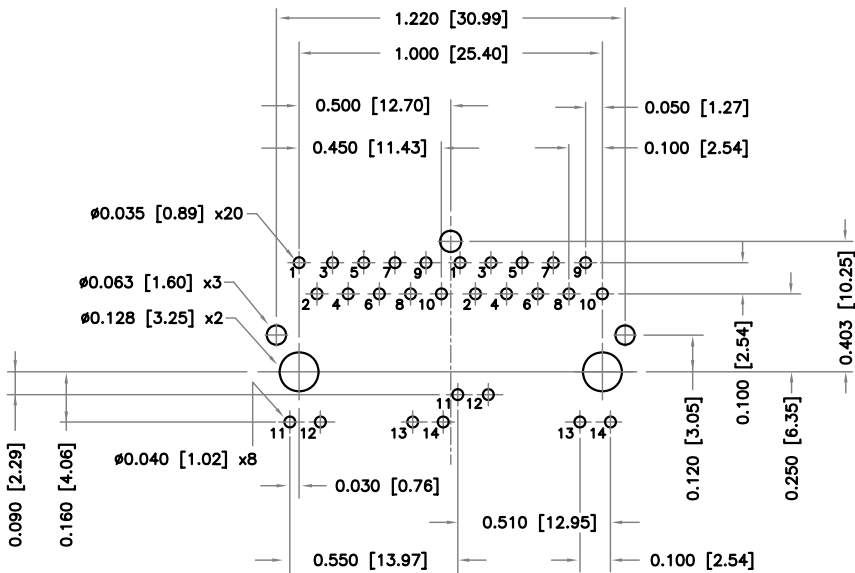

RECOMMENDED P.C. BOARD PATTERN (COMP. SIDE)
TOLERANCES ±0.002 [0.05] UNLESS SPECIFIED

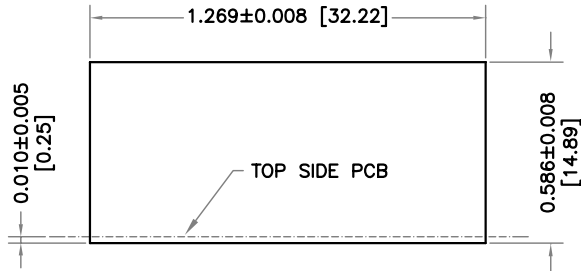

RECOMMENDED PANEL CUTOUT

HALO/PBL	TITLE FastJack™ 1x2		SIGNATURES		DATE	REV.	DESC.	DATE
	FOR GIGABIT ETHERNET		DRAWN PETER LU		8/17/06	A		
CALIFORNIA, USA KOWLOON, HONG KONG SINGAPORE	PART NO. HFJ12-1G01ER-L12RL		CHECKED					
	SCALE NONE	PAGE 2 OF 2	APPROVED					
			FILE HFJ121G01ER-L12RL.DWG					

X-ON Electronics

Largest Supplier of Electrical and Electronic Components

Click to view similar products for [Modular Connectors / Ethernet Connectors](#) category:

Click to view products by [Hakko](#) manufacturer:

Other Similar products are found below :

[8949-H88/06BLKA/SN](#) [74441-0010/BKN](#) [MP1010RX-1000](#) [MP44RX-1000](#) [PHJ-4P4C-1-V-4](#) [PHP-6P6C-5](#) [GAX-3-66](#) [GAX-8-62](#) [GDCX-PA-66-50](#) [GDCX-PN-64](#) [GDCX-PN-66](#) [GDCX-PN-66-50](#) [GDLX-A-66](#) [GDLX-N-66](#) [GDLX-S-66](#) [GDLX-S-88K](#) [GDLX-SMT-S-88](#) [GDTX-S-88-50](#) [GDX-PA-1010](#) [GLX-N-1010M-BLK](#) [GLX-S-88M-BLK](#) [GMX-N-1010](#) [GMX-S-1010](#) [GMX-S-66](#) [GMX-SMT4-N-88](#) [GPX-2-64](#) [GSGX-N-2-88](#) [GSGX-N-4-88](#) [GSX-NS2-88-3.05](#) [GSX-NS2-88-3.05-50](#) [GSX-NS-88-3.05-50](#) [PT-108A-8C-UL](#) [PT-J951-8C](#) [PTS-J531-8CS-50UL](#) [1-1775629-2](#) [A-2014-0-4](#) [GWLX-S-88-GR](#) [GWLX-S9-88-YG](#) [DC-1021-8-WH-6](#) [1300530003](#) [1324640-4](#) [RJ11FTVC2G](#) [RJ11FTVC2N](#) [RJFTVX2SA1G](#) [132764-001](#) [1413235](#) [MP88X-1000](#) [MPS88RX-5000](#) [E5288-S000K3-L](#) [E5908-15A242-L](#)