

Switched 56/DDS/DS Modules

Single or Dual Core SMD Packages

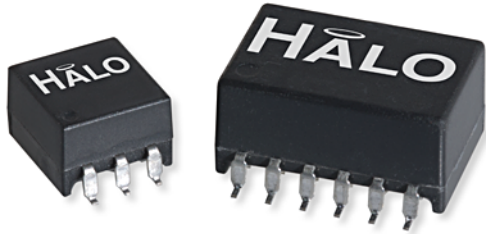

Product Features:

- Standard series of single and dual core Isolation Modules for Switched 56/DDS/DSU/OCU applications
- 1500Vrms Hi-Pot
- Operating Temp 0 to +70°C
- UL/EN60950 Recognized
- Patented Open Frame Construction

Part Number	PRI OCL (mH min)	Turns Ratio $\pm 1\%$ PRI:SEC	Primary Pins	LL (μH max)	Cw/w (μF max)	Circuit Schematic	RoHS
TG04-4004NALF	40	1CT:1CT	1-3	40	150	A	Pb-Free
TG04-4004NARL	40	1CT:1CT	1-3	40	150	A	RoHS (7a)
TG04-4004NCLF	40	1CT:1CT	1-3 & 4-6	40	150	B	Pb-Free
TG04-4004NCRL	40	1CT:1CT	1-3 & 4-6	40	150	B	RoHS (7a)

Notes:

1. Pb-Free parts are RoHS 6/6 compliant. RoHS (7a) parts contain lead per exemption 7a which is set to expire July 2016.
2. Parts with RL suffix are not recommended for new designs.
3. Please contact the factory or representative for individual datasheets or additional information.

Circuit A

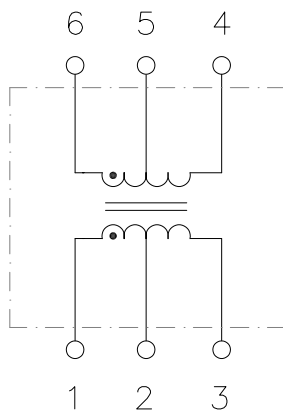

Circuit B

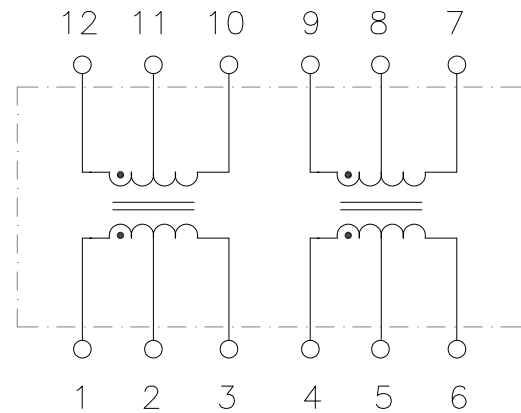

Switched 56/DDS/DS Interface Modules

Package NA

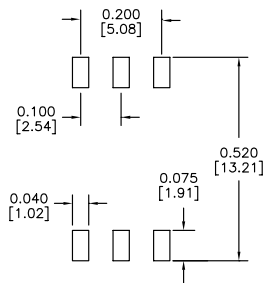
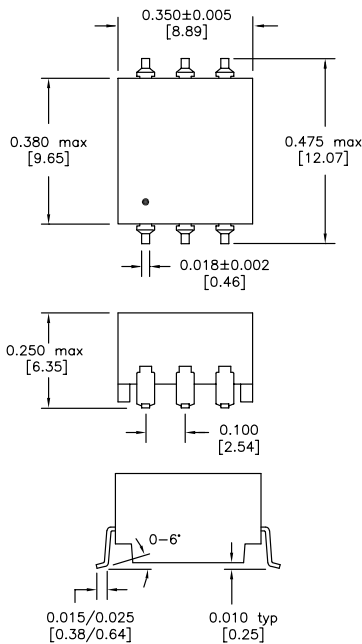

Recommended Solder Pad Dimensions

Package NC

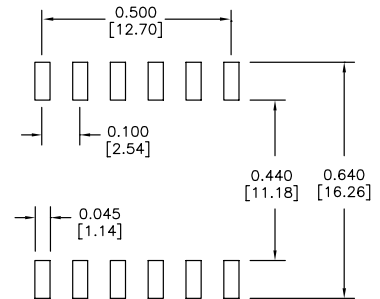
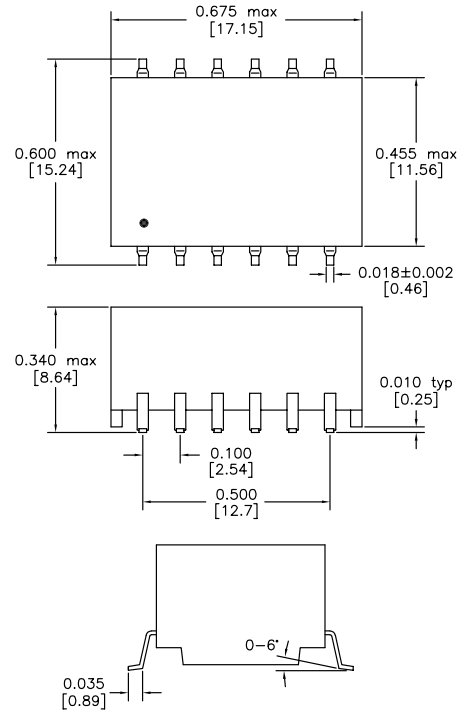

Recommended Solder Pad Dimensions

Dimensions: inch [mm]
Co-Planarity: 0.004 [0.10]

US Patent Numbers

5,656,985 6,297,721 B1
6,297,720 B1 6,320,489 B1
6,344,785 B1 6,662,431 B1



2880 Lakeside Drive #116
Santa Clara, CA 95054
(650) 903-3800

www.haloelectronics.com

HALO® Electronics is a leading supplier of high quality communication magnetics including signal transformers, filters, CMR chokes, PoE power transformers, DC/DC converters, and integrated Ethernet connectors. HALO's leading edge technology solutions are manufactured in ISO9001 and ISO14001 factories offering high quality products at a competitive price.

X-ON Electronics

Largest Supplier of Electrical and Electronic Components

Click to view similar products for [Audio Transformers](#) / [Signal Transformers](#) category:

Click to view products by [Hakko](#) manufacturer:

Other Similar products are found below :

[CX2041NLT](#) [MGPWT-00449-P](#) [PE-64961](#) [H1302FNLT](#) [H5008FNL](#) [H5012FNL](#) [H5020FNLT](#) [H5077NLT](#) [H5079NLT](#) [H5084FNLT](#)
[B78476A9558A003](#) [1812WBT2-4](#) [1879479-1](#) [HX2260FNL](#) [HX5014FNL](#) [EX2024FNL](#) [FL1066](#) [T1137NLT](#) [T3012NL](#) [PE-65812FNL](#) [PE-](#)
[65848FNLT](#) [H1174FNL](#) [H1302FNL](#) [H5015FNL](#) [H5019EFNL](#) [H5062FNLT](#) [CX2047LNL](#) [MGPWT-00059-P](#) [MGPWT-00266-P](#) [MGPWT-](#)
[00278-P](#) [MGPWT-00431-P](#) [TTC-100](#) [TTC-143-H](#) [TTC-5032-1](#) [BX1194WNLT](#) [HX1234NLT](#) [HX5008FNLT](#) [HX5019FNL](#) [HX5084NL](#) [3-](#)
[1879385-5](#) [TX1263NLT](#) [4-1879391-0](#) [T1142NL](#) [HX6101FNL](#) [HX5084FNL](#) [HX1148NL](#) [HX5020FNLT](#) [HX5014FNLT](#) [T1124NL](#)
[1879732-1](#)