

EXTRUSION

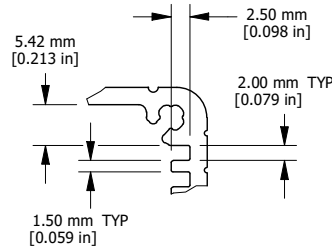

DETAIL A

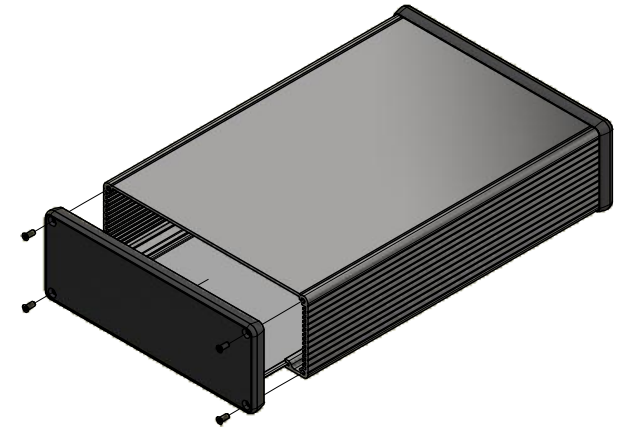

EXPLODED ISOMETRIC VIEW

EXTRUSION DESIGNED FOR 160MM WIDE PC BOARD

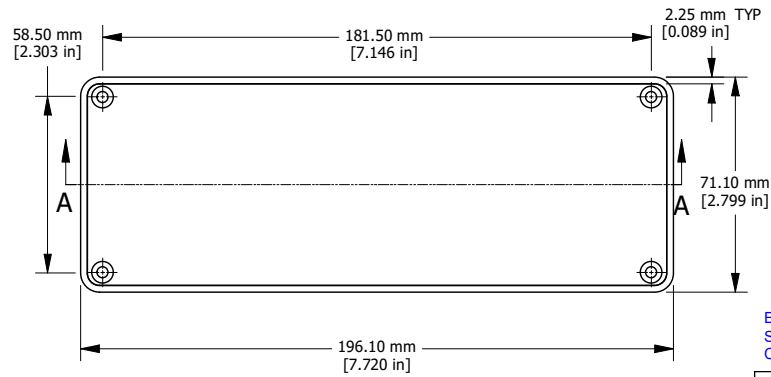
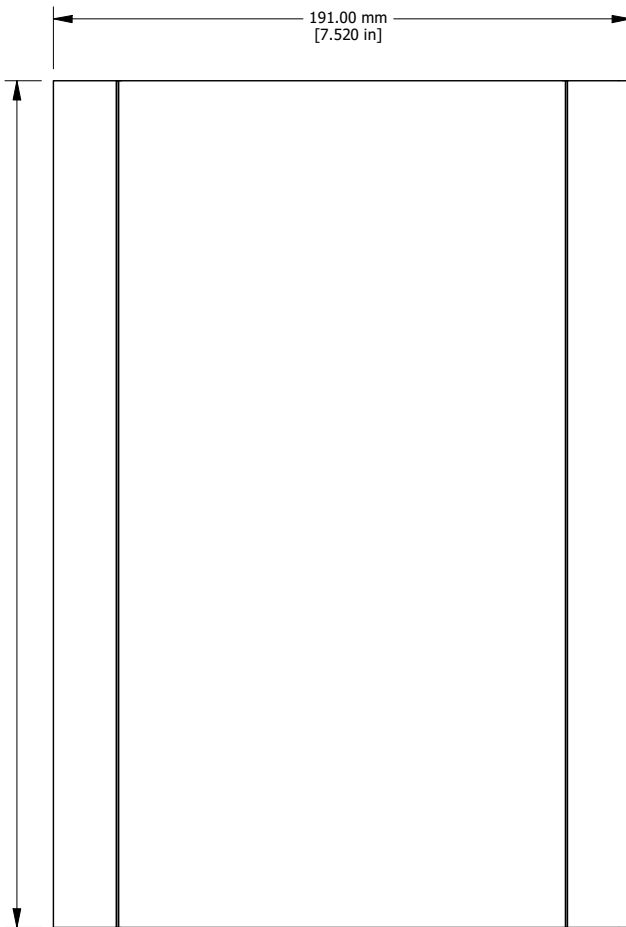

CLOSED BEZEL

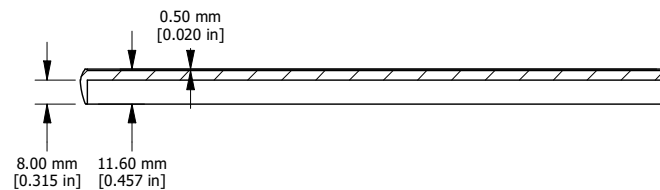

SECTION A-A

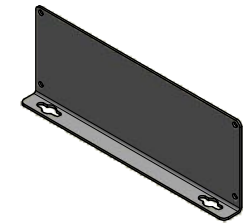

OPTIONAL FLANGED  
END PANELS 1455UF

Enclosures can be Factory Modified ( Milling, Drilling, Printing etc. )  
Solid models of this enclosure available in STEP or IGES.  
Contact Factory [mjm@hammondmfg.com](mailto:mjm@hammondmfg.com)

**NOTE**

Purchased assembly includes box, plastic bezels, #6 Taptight screws and self adhesive rubber feet.

Box made from Extruded Aluminum 6063.

Bezels made with ABS.

**1455U2802**

**PART NUMBERS**

Clear Anodized	1455U2802
Black Anodized	1455U2802BK

**ACCESSORIES**

See website for accessories.



**HAMMOND  
MANUFACTURING™**

**1455U2802**

[www.hammondmfg.com](http://www.hammondmfg.com)

## X-ON Electronics

Largest Supplier of Electrical and Electronic Components

*Click to view similar products for [Enclosures, Boxes & Cases](#) category:*

*Click to view products by [Hammond](#) manufacturer:*

Other Similar products are found below :

[585-R-WH-PK](#) [M-10-PLATED](#) [61000-510-000](#) [C-23 Black Kit](#) [M18-PLTD](#) [M-21-PLATED](#) [63310-01-000](#) [6711GSKT](#) [74257-510-000](#) [CNL-0004](#) [MDC-1183-PLAIN-ALUM](#) [MDC-1183-PTD](#) [MDC-13104-PTD](#) [MDC-973-PTD](#) [76](#) [77153-01-028](#) [FLX6030](#) [83535-01-508](#) [90026-501-000](#) [PS36-200](#) [116-508](#) [120-407](#) [120-910](#) [127-908](#) [130-008](#) [1301170079](#) [1322GSKTEP](#) [1325GSKT3](#) [138-PLAIN](#) [1434-1210](#) [1804RP-RB-PK](#) [190-005](#) [2202307](#) [KAB3321](#) [BLACK](#) [KAB3421](#) [2697466](#) [S52213](#) [2901123](#) [2901699](#) [A0645271](#) [A20P20](#) [2106-IR](#) [PERF-850-PLN](#) [G505025B](#) [2790318](#) [2792057](#) [2890386](#) [2906238](#) [2906241](#) [2906254](#) [2907981](#) [H5031](#) [M-10-LID-PLATED](#)