

**TOP VIEW**

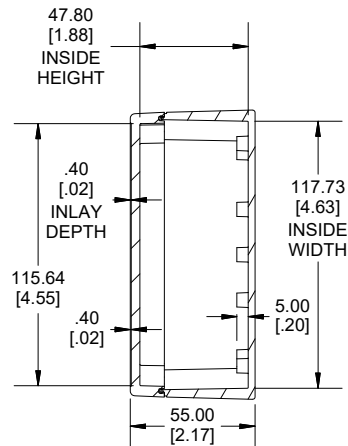

**END VIEW SECTION A-A**

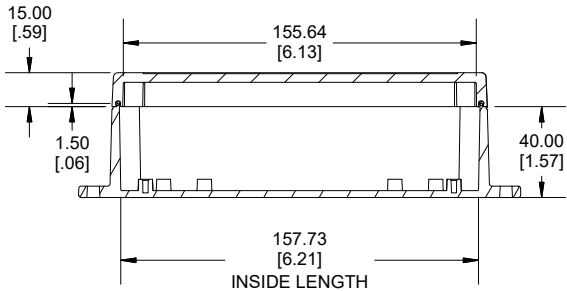
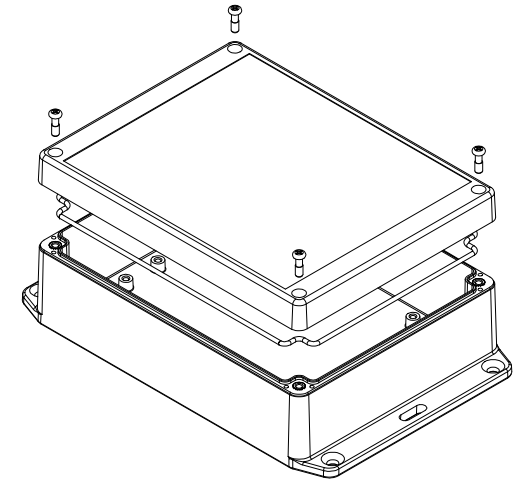

**SIDE VIEW SECTION B-B**

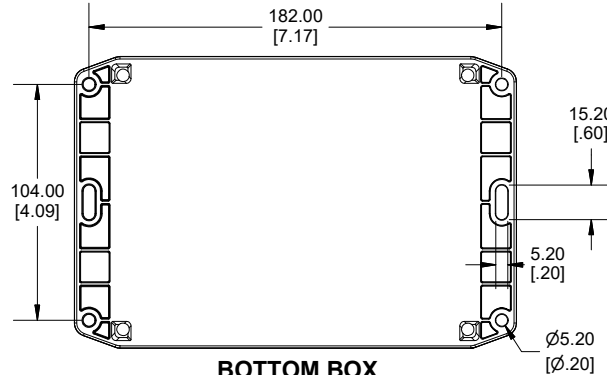

**BOTTOM BOX**

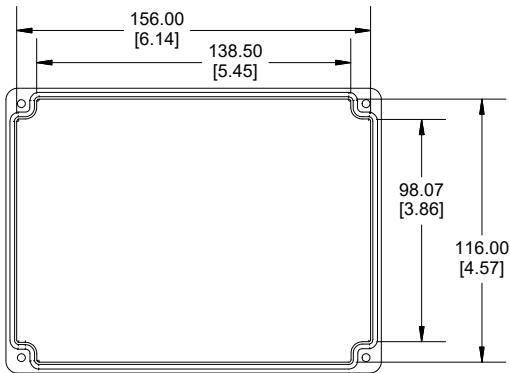

**INSIDE LID**

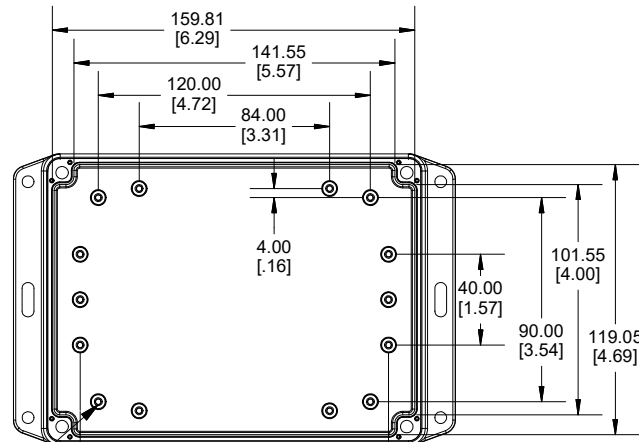

**INSIDE BOX**

ACCEPTS M3 SELF-TAPPING SCREW

Dimensions:  
mm  
[inches]

Enclosures can be Factory Modified (Milling, Drilling, Printing etc.)  
Contact Factory ([modshop@hammfg.com](mailto:modshop@hammfg.com)) for quotes  
Solid models of this enclosure available in .stp or .x\_t  
(Part number and text placement/orientation on our products are subject to change, we do not recommend using them as a locating reference for modification purposes)

**NOTE**

Purchased assembly includes box, lid, string gasket, 4 PCB screws, and 4 lid screws.

Recommended Torque : (43-50) Ozf.in / (30-35) cN.m

**RP Enclosure**

General Purpose ABS Light Grey (UL94 HB)	RP1235BF
General Purpose ABS Light Grey with Polycarbonate Clear Lid (UL94 HB)	RP1235CBF
Polycarbonate Off-White (UL94-V2)	RP1230BF
Polycarbonate Off-White with Clear Lid (UL94-V2)	RP1230CBF

**ACCESSORIES**

Lid Screw (M3.5-0.6 X 10mm) (50 Pkg)	SC619-50
PCB Screw (M3 X 6mm Self-tapping) (50 Pkg)	SC622-50
General Purpose ABS Black Inner Panel 3mm Thick	STC124
Metal Inner Panel 1mm Thick	STA124
String Gasket EPDM Grey (2 Pkg)	RP124GASKET

**HAMMOND MANUFACTURING**  
**RP123 BF**  
[www.hammondmfg.com](http://www.hammondmfg.com)

## X-ON Electronics

Largest Supplier of Electrical and Electronic Components

*Click to view similar products for [Enclosures, Boxes & Cases](#) category:*

*Click to view products by [Hammond](#) manufacturer:*

Other Similar products are found below :

[M-10-PLATED](#) [60221-01](#) [M17-L-PLN](#) [M-21-PLATED](#) [63310-01-000](#) [6711GSKT](#) [90026-501-000](#) [PS36-200](#) [120-407](#) [138-PLAIN](#) [144011](#)  
[EAS-500 \(BLACK ANO\)](#) [2062750000](#) [KAB3421](#) [A0645271](#) [1928952](#) [2106-IR](#) [2792057](#) [2906241](#) [2906254](#) [H5031](#) [M-10-LID-PLATED](#)  
[CU-284](#) [402-BLACK](#) [MDC-532-PLAIN-ALUM](#) [B137](#) [5400TN](#) [UNC 2-4-6 PLAIN](#) [462-0020E](#) [0542100012](#) [043853](#) [103031](#) [11416P](#) [KR8-](#)  
[315](#) [UM-SE-A73-R BK](#) [2202158](#) [TUF 55 25 100 ME](#) [332-907](#) [4122](#) [EKJB](#) [24560-245](#) [736-409](#) [144012](#) [61-9480.6](#) [134573](#) [M18-L-PLTD](#)  
[73095-510-000](#) [CNM-0303 Black](#) [S3A-453213-S](#) [ALUG702RD040-IR](#) [07.6370000](#)