

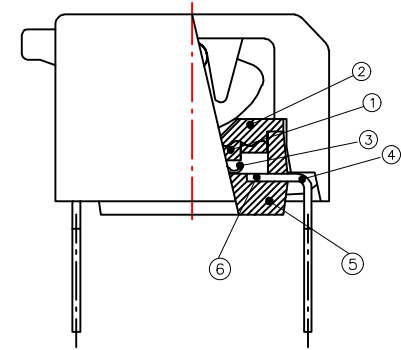

REV.	ECN NO OR DESCRIPTION	REVISED	DATE

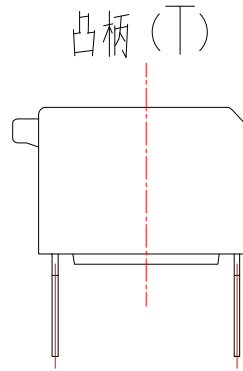
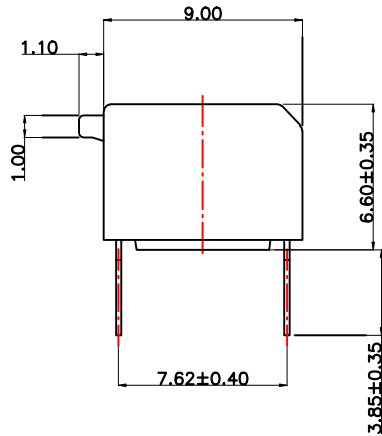
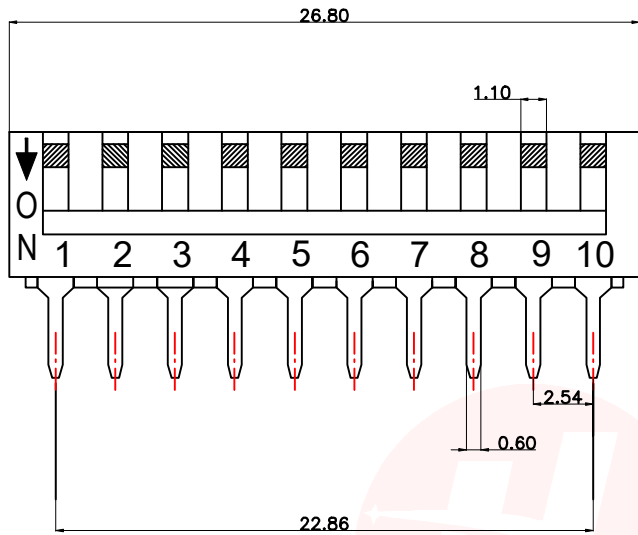

NOTES :

1.Specification:

- 1>.Operating force:1000gf Max
- 2>.Operating Temperature:-40° to+85°
- 3>.Storage Temperature:-40° to+85°
- 4>.Mechanical Life:3000cycles minimum
- 5>.Electrical Life:2000cycles minimum

2. PLATING:

GOLD FLASH 1u"~2u" SOLDER TAIL,
1u"~3u" GOLD PLATING ON THE CONTACT AREA,
WITH 50u" NICKEL UNDERPLATING OVERALL.

3. CONTACT RATING:

- 1.SWITCHING:25mA at 24VDC
- 2.NON-SWITCHING:100mA at 50VDC
WITH 50u" NICKEL UNDERPLATING OVERALL.

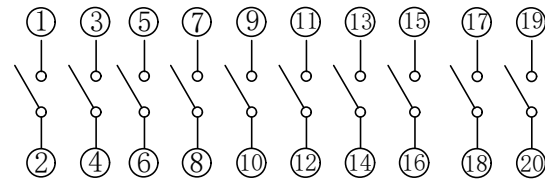
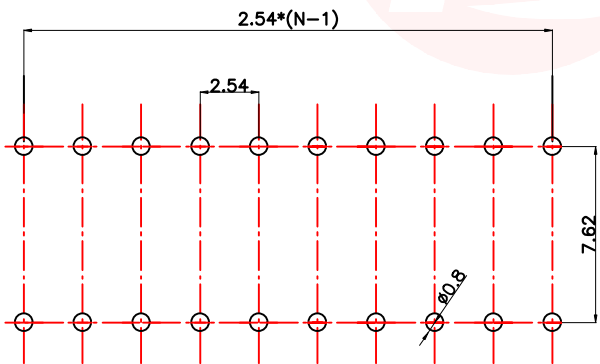
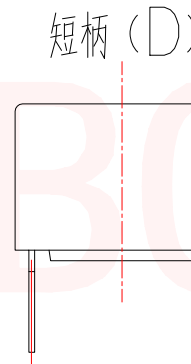

[Schematic]

Number	Part Name	Material	Finished
①	Actuator	UL94 V0	White
②	Cover	UL94 V0	Black
③	Movable	Copper Alloy	1u"~3u" Gold
④	Terminal	Brass	1u"~2u" Gold
⑤	Base	UL94 V0	Black
⑥	Terminal Contact	Brass	1u"~3u" Gold

UNLESS OTHERWISE SPECIFIED TOLERANCES



东莞市汉博电子科技有限公司
DONGGUAN HANBO TECHNOLOGY CO., LTD

DECIMALS: ANGLES:

- X :±0.30 X :±2°
- X.X :±0.20 X.X :±1°
- X.XX :±0.10

TITLE BY DSPV DIP SERIES PITCH 2.54mm

DWN	xiong	PART NO. DE-10PT	
CHKD	lee	SCALE:1:1	UNIT: mm
APVD	wang	SIZE: A4	SHEET:10F 1
REV: A4			

CUSTOMER COPY

PART NO.	凸柄 (T)	DE-01PT	DE-02PT	DE-03PT	DE-04PT	DE-05PT	DE-06PT	DE-07PT	DE-08PT	DE-010PT
盖子/黑色	短柄 (D)	DE-01PD	DE-02PD	DE-03PD	DE-04PD	DE-05PD	DE-06PD	DE-07PD	DE-08PD	DE-010PD

X-ON Electronics

Largest Supplier of Electrical and Electronic Components

Click to view similar products for [DIP Switches/SIP Switches](#) category:

Click to view products by [Hanbo Electronic](#) manufacturer:

Other Similar products are found below :

[79B10T](#) [8136-475G4T](#) [G7G-1A2-CB-DC12](#) [DRS4016](#) [1825444-1](#) [193005MS](#) [195010MS](#) [200183](#) [206002](#) [208004](#) [208007ST](#) [208008](#)
[25.350.0653.0](#) [SDA10H1BDA](#) [97R06ST](#) [A2C-2A5](#) [1825444-7](#) [ADE12S04](#) [206005RAS](#) [209005LPST](#) [2-1825058-8](#) [219002LPST](#)
[219002MSTJRF](#) [219012MST](#) [25.352.0353.0](#) [CXDRIVEV2X](#) [LA2-002-DC24](#) [DSR02T](#) [193004MS](#) [E2FMX2D1M1TGJ03M](#) [NDI10H](#) [219-](#)
[9MSTP](#) [219008LPSTR](#) [EPM02FV](#) [206010RAST](#) [76SB05](#) [TD06H0SK1](#) [Z7.255.9027.0](#) [1-1825058-3](#) [1825428-4](#) [219-10LPSTF](#)
[E3ZG6111D03M](#) [G4D212PUSTV2DC5](#) [HARW0002](#) [EPG301BT06](#) [1-1825058-6](#) [E3TSL23M5J03M](#) [Y5795](#) [7R0060](#) [HARW0001](#)