

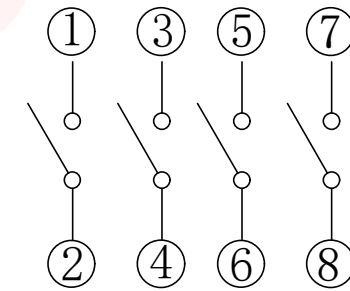

REV.	ECN NO OR DESCRIPTION	REVISED	DATE

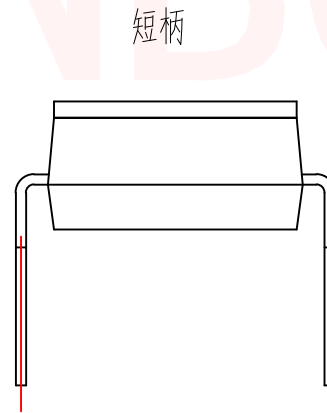
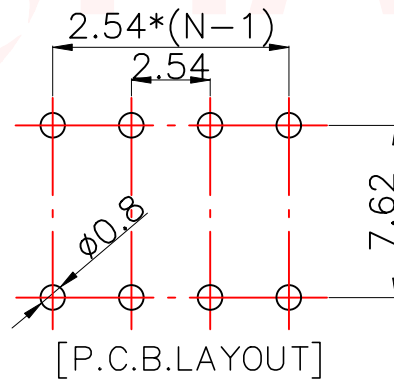
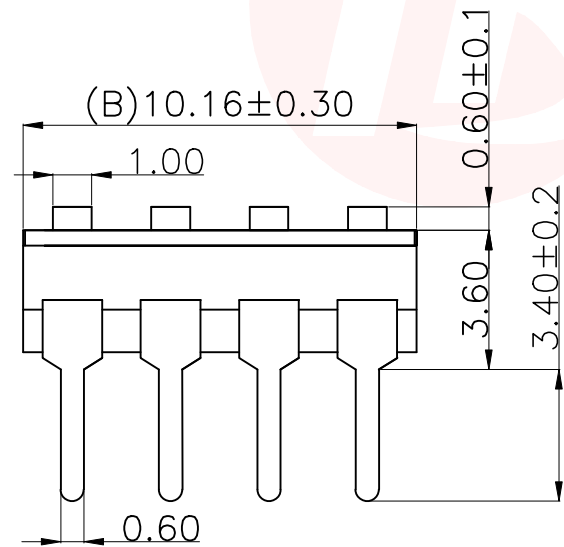
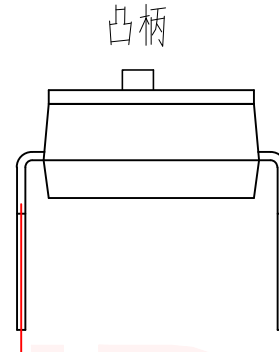
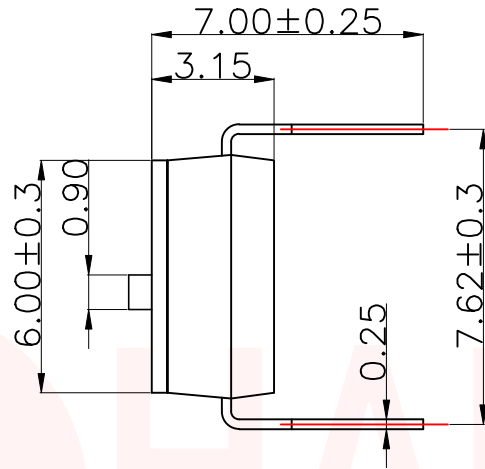
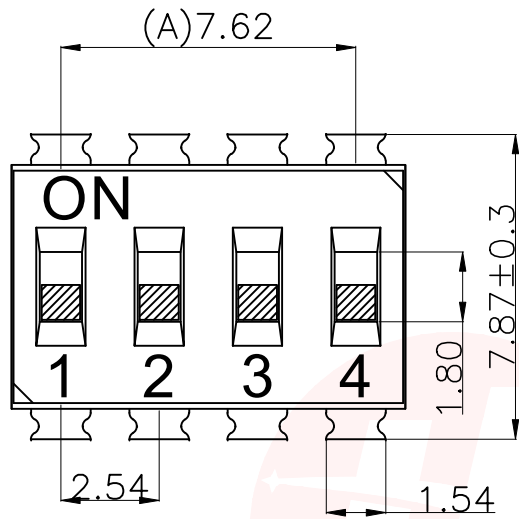

[Schematic]

**NOTES:**

**1.Specification:**

- 1>.Operation force: 1000gf Max.
- 2>.Operation Temperature: -30°Cto+85°C.
- 3>.Storage Temperature: -40°Cto+85°C.
- 4>.Mechanical Life: 3000 cycles operations.
- 5>.Resistance to Soldering: 260±5°C for 3-5 Seconds.

**2.PLATING:**

- 1>.GOLD flash 1u" (min) SOLDER TAIL, 3u" GOLD PLATING ON THE CONTACT AREA.

**3.ELECTRICAL:**

- 1>.Non-switch Rating:100mA at 50V DC.
- 2>.Switching Rating: 25mA at 24V DC.
- 3>.Contact Resistance: Inital 50mΩ Max. Contact Resistance: After life 100mΩ Max.
- 4>.Insulation Resistance:1000MΩ Min at500VDC.
- 5>.Dielectric Strength: 500V AC for 60seconds.
- 6>.Switch Capacitance: 5PF Max at 1MHZ.

UNLESS OTHERWISE SPECIFIED TOLERANCES

DECIMALS: ANGLES:  
 X :±0.30 X :±2°  
 X.X :±0.20 X.X :±1°  
 X.XX :±0.10



东莞市汉博电子科技有限公司  
 DONGGUAN HANBO TECHNOLOGY CO., LTD

TITLE	DSIC product series with a spacing of 2.54mm			
DWN	xiong	PART NO. DP-04PT		
CHKD	lee	SCALE:1:1	UNIT: mm	
APVD	wang	SIZE: A4	SHEET:10F 1	REV: A4
CUSTOMER COPY				

PART NO.	凸柄 (T)	DP-01PT	DP-02PT	DP-03PT	DP-04PT	DP-05PT	DP-06PT	DP-07PT	DP-08PT	DP-010PT
盖子/黑色	短柄 (D)	DP-01PD	DP-02PD	DP-03PD	DP-04PD	DP-05PD	DP-06PD	DP-07PD	DP-08PD	DP-010PD

## X-ON Electronics

Largest Supplier of Electrical and Electronic Components

*Click to view similar products for [DIP Switches/SIP Switches](#) category:*

*Click to view products by [Hanbo Electronic](#) manufacturer:*

Other Similar products are found below :

[79B10T](#) [8136-475G4T](#) [G7G-1A2-CB-DC12](#) [DRS4016](#) [1825444-1](#) [193005MS](#) [195010MS](#) [200183](#) [206002](#) [208004](#) [208007ST](#) [208008](#)  
[25.350.0653.0](#) [SDA10H1BDA](#) [97R06ST](#) [A2C-2A5](#) [1825444-7](#) [ADE12S04](#) [206005RAS](#) [209005LPST](#) [2-1825058-8](#) [219002LPST](#)  
[219002MSTJRF](#) [219012MST](#) [25.352.0353.0](#) [CXDRIVEV2X](#) [LA2-002-DC24](#) [DSR02T](#) [193004MS](#) [E2FMX2D1M1TGJ03M](#) [NDI10H](#) [219-](#)  
[9MSTP](#) [219008LPSTR](#) [EPM02FV](#) [206010RAST](#) [76SB05](#) [TD06H0SK1](#) [Z7.255.9027.0](#) [1-1825058-3](#) [1825428-4](#) [219-10LPSTF](#)  
[E3ZG6111D03M](#) [G4D212PUSTV2DC5](#) [HARW0002](#) [EPG301BT06](#) [1-1825058-6](#) [E3TSL23M5J03M](#) [Y5795](#) [7R0060](#) [HARW0001](#)