

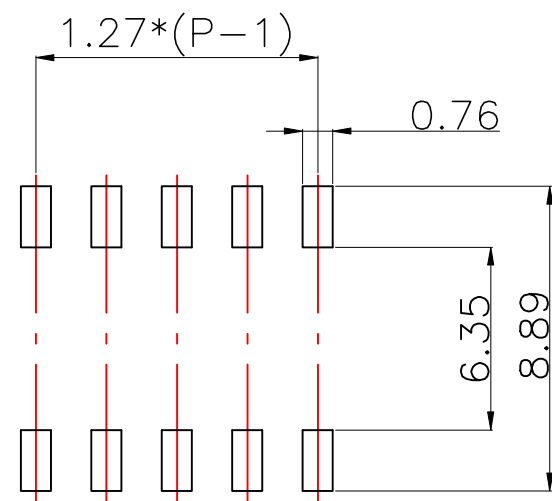

REV.	ECN NO OR DESCRIPTION	REVISED	DATE

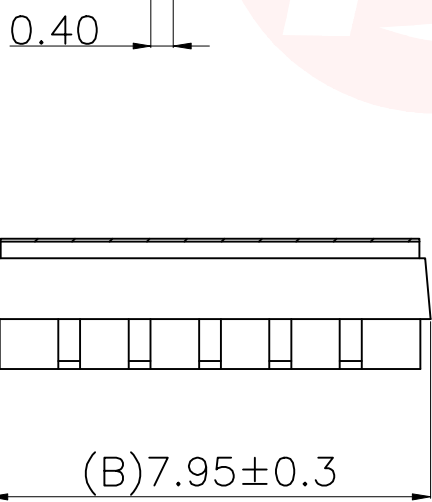
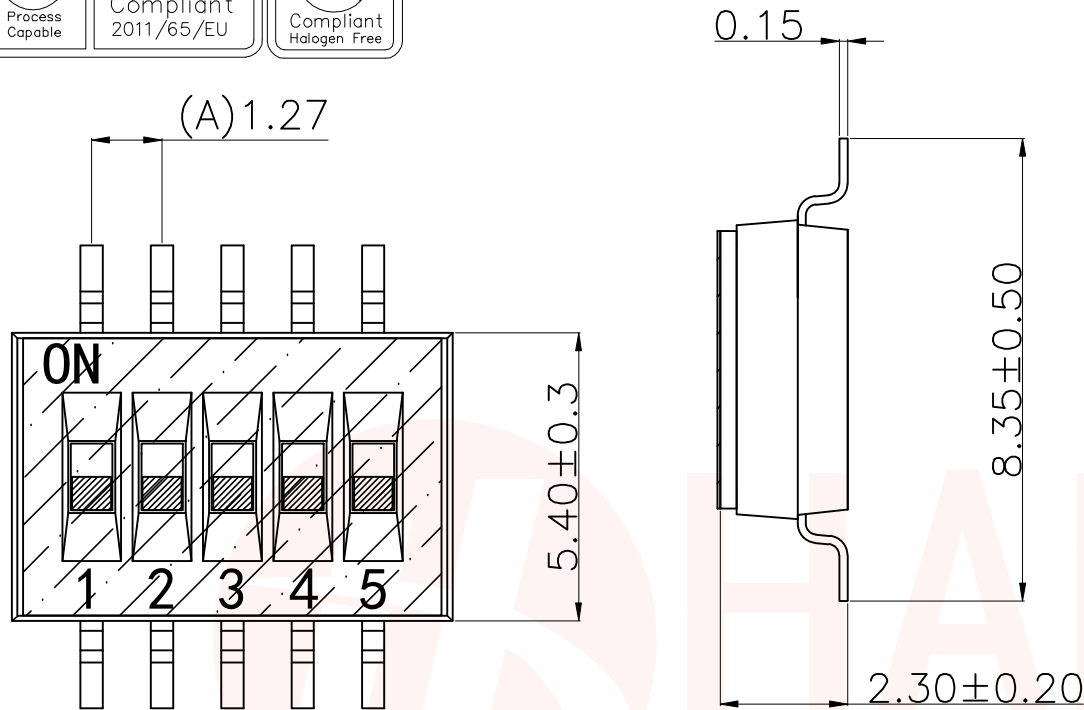

[P.C.B.LAYOUT]

NOTES:

1.Specification:

- 1>.Operation force: 1000gf Max.
- 2>.Operation Temperature: -30°C to +85°C.
- 3>.Storage Temperature: -40°C to +85°C.
- 4>.Mechanical Life: 1000 cycles operations.
- 5>.Resistance to Soldering: 260±5°C for 3-5 Seconds.

2.PLATING:

- 1>.GOLD flash 1u" (min) SOLDERTAIL, 3u" GOLD PLATING ON THE CONTACT AREA.

3.ELECTRICAL:

- 1>.Non-switch Rating:100mA at 50V DC.
- 2>.Switching Rating: 25mA at 24V DC.
- 3>.Contact Resistance: Inital 50mΩ Max. Contact Resistance: After life 100mΩ Max.
- 4>.Insulation Resistance:100MΩ Min at 100VDC.
- 5>.Dielectric Strength: 300V AC for 60seconds.
- 6>.Switch Capacitance: 5PF Max at 1MHZ.

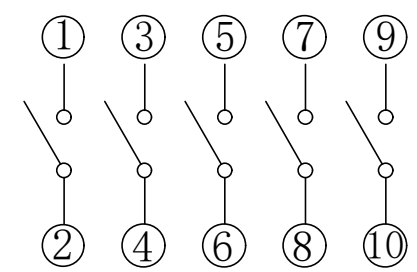

[Schematic]

UNLESS OTHERWISE SPECIFIED TOLERANCES		东莞市汉博电子科技有限公司 DONGGUAN HANBO TECHNOLOGY CO., LTD			
DECIMALS:	ANGLES:	TITLE 1.27 spacing dial switch series			
X :±0.30	X :±2°	DWN	xiong	PART NO. DS-05P	
X.X :±0.20	X.X :±1°	CHKD	lee	SCALE:1:1	UNIT: mm
X.XX :±0.10		APVD	wang	SIZE: A4	SHEET:10F 1
		REV: A4			
CUSTOMER COPY					

X-ON Electronics

Largest Supplier of Electrical and Electronic Components

Click to view similar products for [DIP Switches/SIP Switches](#) category:

Click to view products by [Hanbo Electronic](#) manufacturer:

Other Similar products are found below :

[79B10T](#) [8136-475G4T](#) [G7G-1A2-CB-DC12](#) [DRR60016](#) [DRS4016](#) [1825444-1](#) [200183](#) [206002](#) [219-6LPSTRF](#) [25.350.0653.0](#)
[SDA10H1BDA](#) [97R06ST](#) [A2C-2A5](#) [1825058-4](#) [1825444-7](#) [ADE08SA04](#) [ADE12S04](#) [192960010](#) [206005RAS](#) [206007](#) [2-1825058-8](#)
[25.352.0353.0](#) [CXDRIVEV2X](#) [LA2-002-DC24](#) [DSR02T](#) [E2FMX2D1M1TGJ03M](#) [NDI10H](#) [219-9MSTP](#) [EPM02FV](#) [206010RAST](#) [219-](#)
[5LPSTJRF](#) [76SB05](#) [TD06H0SK1](#) [Z7.255.9027.0](#) [1-1825058-3](#) [1825428-4](#) [219-10LPSTF](#) [E3ZG6111D03M](#) [G4D212PUSTV2DC5](#)
[EPG301BT06](#) [1-1825058-6](#) [E3TSL23M5J03M](#) [Y5795](#) [7R0060](#) [HARW0001](#) [ADE07S04](#) [432220096](#) [206005](#) [206006](#) [206010](#)