

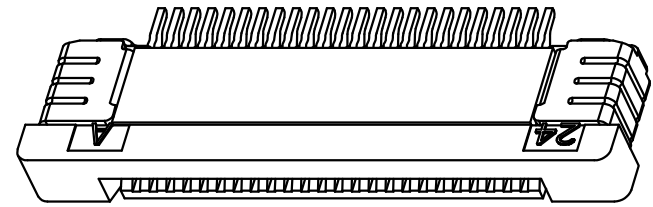

REV.	ECN NO OR DESCRIPTION	REVISED	DATE

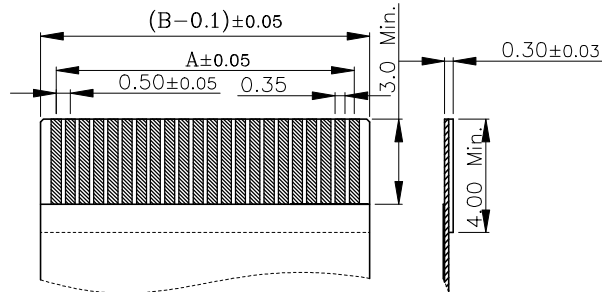

适用扁平线 (Applicable Flat Cable)

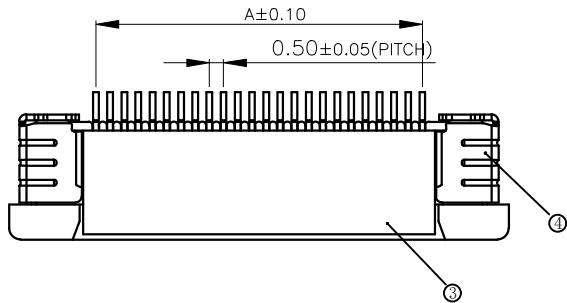
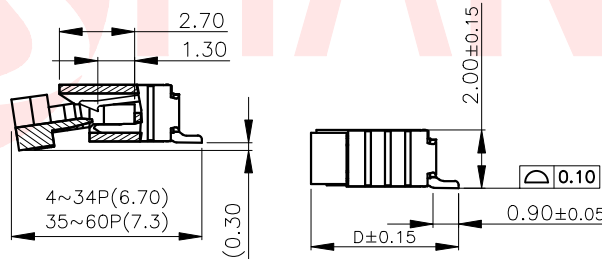
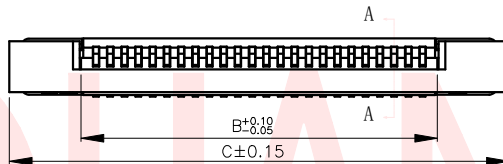
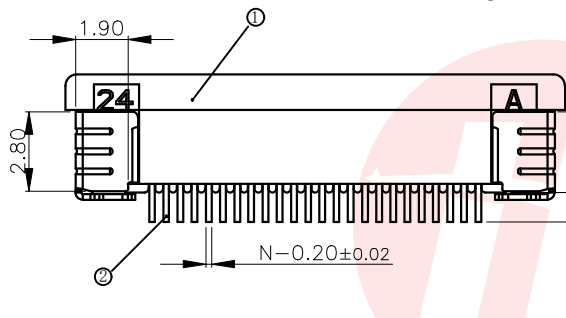

SECTION A-A

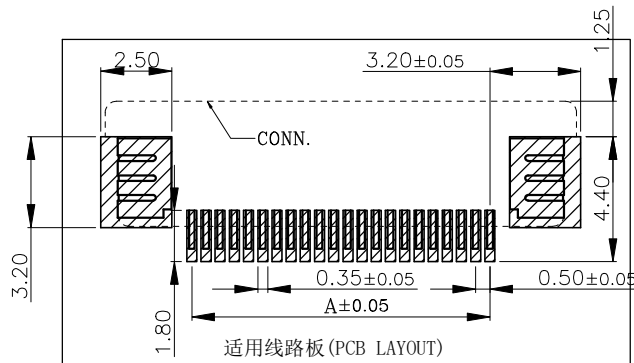

适用线路板 (PCB LAYOUT)

技术指标 (Technical Index):

- 塑件表面应光洁、无毛边、无明显收缩、缺陷、裂纹等现象。
(The surface of the plastic parts should be smooth, no rough edges, no obvious shrinkage, defects, cracks and other phenomena.)
- 温度范围 (Temperature range): -25°C ~ $+85^{\circ}\text{C}$.
- 额定电压 (Rated voltage): 50V, AC/DC (=等效).
- 接触电阻 (Contact resistance): $\leq 0.03\Omega$.
- 绝缘电阻 (Insulation resistance): $\geq 500\text{M}\Omega$.

TABLE:

CSG PART NO.	PIN#	DIM.A	DIM.B	DIM.C	DIM.D	CSG PART NO.	PIN#	DIM.A	DIM.B	DIM.C	DIM.D
HB-FPC-05LBSJ-H204P	4PIN	1.50	2.56	7.60	5.20	HB-FPC-05LBSJ-H2033P	33PIN	16.00	17.06	22.10	5.20
HB-FPC-05LBSJ-H205P	5PIN	2.00	3.06	8.10		HB-FPC-05LBSJ-H2034P	34PIN	16.50	17.56	22.60	5.20
HB-FPC-05LBSJ-H206P	6PIN	2.50	3.56	8.60		HB-FPC-05LBSJ-H2035P	35PIN	17.00	18.06	23.10	5.20
HB-FPC-05LBSJ-H207P	7PIN	3.00	4.06	9.10		HB-FPC-05LBSJ-H2036P	36PIN	17.50	18.56	23.60	5.20
HB-FPC-05LBSJ-H208P	8PIN	3.50	4.56	9.60		HB-FPC-05LBSJ-H2037P	37PIN	18.00	19.06	24.10	5.20
HB-FPC-05LBSJ-H209P	9PIN	4.00	5.06	10.10		HB-FPC-05LBSJ-H2038P	38PIN	18.50	19.56	24.60	5.20
HB-FPC-05LBSJ-H2010P	10PIN	4.50	5.56	10.60		HB-FPC-05LBSJ-H2039P	39PIN	19.00	20.06	25.10	5.20
HB-FPC-05LBSJ-H2011P	11PIN	5.00	6.06	11.10		HB-FPC-05LBSJ-H2040P	40PIN	19.50	20.56	25.60	5.20
HB-FPC-05LBSJ-H2012P	12PIN	5.50	6.56	11.60		HB-FPC-05LBSJ-H2041P	41PIN	20.00	21.06	26.10	5.20
HB-FPC-05LBSJ-H2013P	13PIN	6.00	7.06	12.10		HB-FPC-05LBSJ-H2042P	42PIN	20.50	21.56	26.60	5.20
HB-FPC-05LBSJ-H2014P	14PIN	6.50	7.56	12.60		HB-FPC-05LBSJ-H2043P	43PIN	21.00	22.06	27.10	5.20
HB-FPC-05LBSJ-H2015P	15PIN	7.00	8.06	13.10		HB-FPC-05LBSJ-H2044P	44PIN	21.50	22.56	27.60	5.20
HB-FPC-05LBSJ-H2016P	16PIN	7.50	8.56	13.60		HB-FPC-05LBSJ-H2045P	45PIN	22.00	23.06	28.10	5.20
HB-FPC-05LBSJ-H2017P	17PIN	8.00	9.06	14.10		HB-FPC-05LBSJ-H2046P	46PIN	22.50	23.56	28.60	5.20
HB-FPC-05LBSJ-H2018P	18PIN	8.50	9.56	14.60		HB-FPC-05LBSJ-H2047P	47PIN	23.00	24.06	29.10	5.20
HB-FPC-05LBSJ-H2019P	19PIN	9.00	10.06	15.10		HB-FPC-05LBSJ-H2048P	48PIN	23.50	24.56	29.60	5.20
HB-FPC-05LBSJ-H2020P	20PIN	9.50	10.56	15.60		HB-FPC-05LBSJ-H2049P	49PIN	24.00	25.06	30.10	5.20
HB-FPC-05LBSJ-H2021P	21PIN	10.00	11.06	16.10		HB-FPC-05LBSJ-H2050P	50PIN	24.50	25.56	30.60	5.20
HB-FPC-05LBSJ-H2022P	22PIN	10.50	11.56	16.60		HB-FPC-05LBSJ-H2051P	51PIN	25.00	26.06	31.10	5.20
HB-FPC-05LBSJ-H2023P	23PIN	11.00	12.06	17.10		HB-FPC-05LBSJ-H2052P	52PIN	25.50	26.56	31.60	5.20
HB-FPC-05LBSJ-H2024P	24PIN	11.50	12.56	17.60		HB-FPC-05LBSJ-H2053P	53PIN	26.00	27.06	32.10	5.20
HB-FPC-05LBSJ-H2025P	25PIN	12.00	13.06	18.10		HB-FPC-05LBSJ-H2054P	54PIN	26.50	27.56	32.60	5.20
HB-FPC-05LBSJ-H2026P	26PIN	12.50	13.56	18.60		HB-FPC-05LBSJ-H2055P	55PIN	27.00	28.06	33.10	5.20
HB-FPC-05LBSJ-H2027P	27PIN	13.00	14.06	19.10		HB-FPC-05LBSJ-H2056P	56PIN	27.50	28.56	33.60	5.20
HB-FPC-05LBSJ-H2028P	28PIN	13.50	14.56	19.60		HB-FPC-05LBSJ-H2057P	57PIN	28.00	29.06	34.10	5.20
HB-FPC-05LBSJ-H2029P	29PIN	14.00	15.06	20.10		HB-FPC-05LBSJ-H2058P	58PIN	28.50	29.56	34.60	5.20
HB-FPC-05LBSJ-H2030P	30PIN	14.50	15.56	20.60		HB-FPC-05LBSJ-H2059P	59PIN	29.00	30.06	35.10	5.20
HB-FPC-05LBSJ-H2031P	31PIN	15.00	16.06	21.10		HB-FPC-05LBSJ-H2060P	60PIN	29.50	30.56	35.60	5.20
HB-FPC-05LBSJ-H2032P	32PIN	15.50	16.56	21.60							

序号 (NO.)	品名 (Name)	材质 (Material)
①	0.5拉拔3代胶芯 (H2.0) 0.5 Pitch ZIF Type 3 Housing (H=2.0)	LCP UL94V-0 本色 Natural
②	0.5拉拔上接端子 (H2.0) 0.5 Pitch H2.0 ZIF R/A Type Upper terminal	磷青铜/表面镀锡 Phosphor Bronze/ Tin Plating
③	0.5拉拔3代后盖 (H2.0) 0.5 Pitch ZIF Type 3 Actuator (H=2.0)	LCP UL94V-0 黑色 Black
④	0.5拉拔3代焊片 (H2.0) 0.5 Pitch ZIF Type 3 Fitting Nail (H=2.0)	黄铜/表面镀锡 Brass/Tin Plating

UNLESS OTHERWISE SPECIFIED TOLERANCES

DECIMALS:	ANGLES:
X :±0.30	X :±2°
X.X :±0.20	X.X :±1°
X.XX :±0.10	



东莞市汉博电子科技有限公司
DONGGUAN HANBO TECHNOLOGY CO., LTD

TITLE	0.5 Pitch H2.0 ZIF R/A Type 3 Upper SMT CONN.			
DWN	xiong	PART NO. HB-FPC-05LBSJ-H20NP		
CHKD	lee	SCALE:1:1	UNIT: mm	
APVD	wang	SIZE: A4	SHEET:1OF 1	REV: A4
CUSTOMER COPY				

X-ON Electronics

Largest Supplier of Electrical and Electronic Components

Click to view similar products for [FFC & FPC Connectors](#) category:

Click to view products by [Hanbo Electronic](#) manufacturer:

Other Similar products are found below :

[00-6200-227-022-800](#) [006205250500825+](#) [006205280500825+](#) [FPH-1602G](#) [086222026001800](#) [52610-0675](#) [62674-201121DLF](#) [52746-1671-TR250](#) [10051922-1610EHLF](#) [10051922-2810EHLF](#) [686322124422](#) [XF3M-2915-1B-R100](#) [AYF353125A](#) [AYF530665TA](#) [AYF534065TA](#) [20FLH-RSM1-TB](#) [PCA-7F-25-HL-3-G](#) [207356-1](#) [52807-0430](#) [502250-8027](#) [FH28K-40S-0.5SH](#) [200528-0260](#) [FH28K-10S-0.5SH](#) [501951-1250](#) [X05B20U43T](#) [0.5K-DX-30PWB](#) [DS1020-08-10VBT12](#) [THD0515-34CL-GF](#) [X05A10L28G](#) [ECC2841061EU](#) [20539-030E-01](#) [1.0K-DHQX-16PWB](#) [1.0K-DHQX-30PWB](#) [1775333-6](#) [10054365-202110ELF](#) [10054365-242110ELF](#) [10054365-282110ELF](#) [10064555-392220HLF](#) [59453-041110EBHLF](#) [59453-091110EDHLF](#) [62674-241141ALF](#) [62684-432100ALF](#) [62684-451100AHLF](#) [62684-5721N0ALF](#) [HFW11R-1STE1MTLF](#) [HFW12R-1STE9LF](#) [HFW14R-1STE9MTLF](#) [HFW18S-2STE9LF](#) [HFW20R-1STAE1HLF](#) [HFW20R-1STE1MTLF](#)