

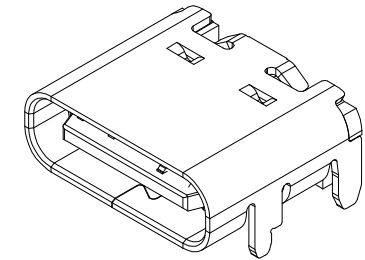

REV.	ECN NO OR DESCRIPTION	REVISED	DATE

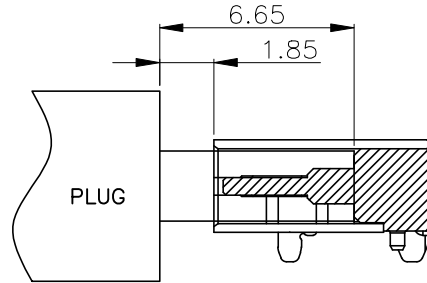
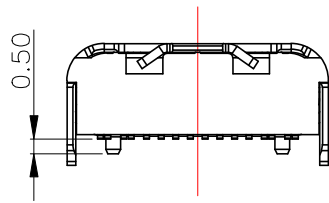
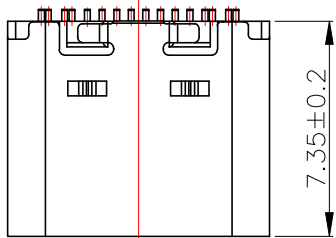

公母对插后尺寸

备注:

1. 材质及电镀: 见附表1
2. 电气性能:
 - 2.1 接触电阻: 30mΩ Max FOR INITIAL, 40mΩ Max AFTER TEST.
 - 2.2 耐电压: 100V AC
 - 2.3 绝缘: 100MΩ Min
 - 2.4 额定电流: COLLECTIVELY VBUS PIN (A4,A9,B4,B9), TOTAL 5A
VCCON PIN (B5) THROUGH GND
PIN(A1,A12,B1,B12), 1.25A
OTHERS PIN, 0.25A
 - 2.5 工作温度: -40°C ~ 80°C.
3. 机械性能:
 - 3.1 插入力: 5~20N.
 - 3.2 拔出力: 初始值8~20N 测试后6~20N
 - 3.3 寿命: 10,000 CYCLES

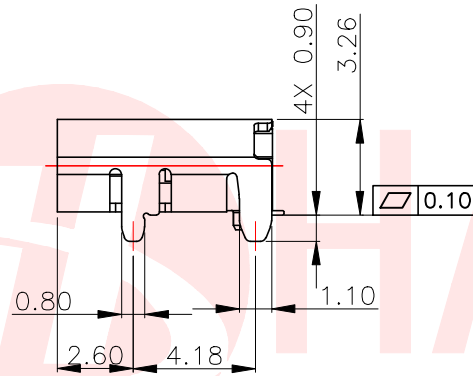
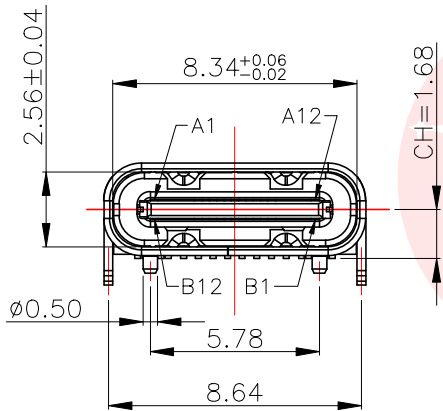
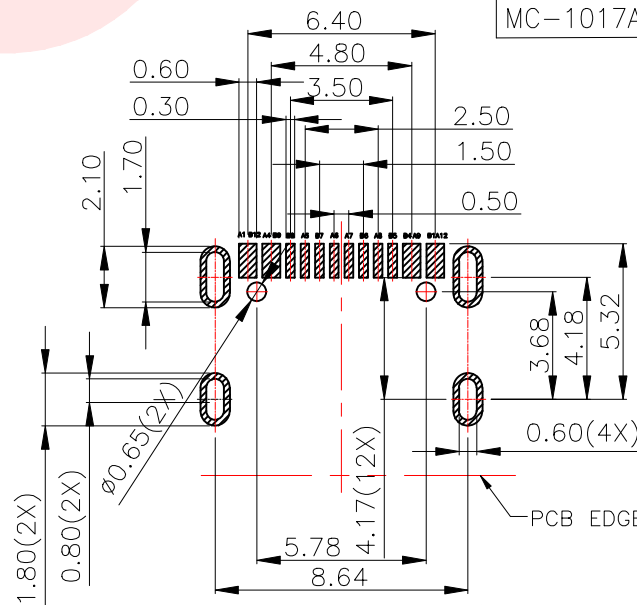
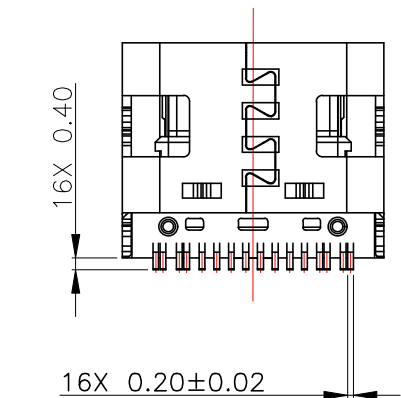

TABLE:

CSG PART NO.	颜色
MC-1017ABP16	白色
MC-1017ALP16	蓝色
MC-1017ACP16	橙色
MC-1017ALLP16	绿色



RECOMMENDED PCB LAYOUT(TOP VIEW)
THICKNESS 0.80MM;DEFAULT TOLERANCE:±0.05

序号	品名	材质	用量	备注
07	外壳	不锈钢	1	SUS 304 1/2H,T0.30
06	二次Molding件	LCP	1	黑色 UL94 V-0
05	Molding件2	LCP	1	黑色 UL94 V-0
04	Molding件1	LCP	1	黑色 UL94 V-0
03	中夹片	SUS301-H T=0.15	1	不电镀
01	端子	C2680-H T=0.15	1set	功能接触区镀金, 焊脚镀金

UNLESS OTHERWISE SPECIFIED TOLERANCES

DECIMALS: ANGLES:
X :±0.30 X :±2°
X.X :±0.20 X.X :±1°
X.XX :±0.10



东莞市汉博电子科技有限公司
DONGGUAN HANBO TECHNOLOGY CO., LTD

TITLE	TYPE C 16PIN单排7.35板上插件		
DWN	xiong	PART NO. MC-1017A**P16	
CHKD	lee	SCALE:1:1	UNIT: mm
APVD	wang	SIZE: A4	SHEET:10F 1
REV: A4			
CUSTOMER COPY			

X-ON Electronics

Largest Supplier of Electrical and Electronic Components

Click to view similar products for [USB Connectors](#) category:

Click to view products by [Hanbo Electronic](#) manufacturer:

Other Similar products are found below :

[950](#) [MUSBD11135](#) [17-200721](#) [217450-1](#) [KMBVX-TH-5S-B30](#) [KUSBX-AS2N-W](#) [KUSBX-SMT2AP1S-W30](#) [935](#) [957](#) [30-498-6](#) [SK-60A-2](#)
[1734082-1](#) [30-470](#) [30-489](#) [30-541](#) [A-USB A-2P-C](#) [MIKROE-1451](#) [USBFTVSCCG](#) [1-1734084-2](#) [10135326-001LF](#) [4198](#) [USB-A-D-VT](#)
[USB-A-S-RA-TSMT](#) [1310-1023-02](#) [690-024-633-031](#) [UB-20PMFP-LC7001](#) [17-200011](#) [UB-20AFMM-LL7A01](#) [1040870124](#) [CAP-](#)
[WCCMLPB1](#) [CAP-WCCMLPC1](#) [2274475-3](#) [UB-20BMFA-SL8001](#) [914-614A2025S10200](#) [USB3FTV7SAGF059](#) [ZX40-B-5S-1500-](#)
[STDA\(30\)](#) [GSB3116344HR](#) [USB3FTV2SAZNF459](#) [USB3FTV7SAZNF459](#) [U221-041N-1WVS62-F5D](#) [HYCW153-USBD05-500B](#)
[HYCW219-USBD05-075B](#) [HYCW148-USBD05-117B](#) [HYCW149-USBD05-740B](#) [HYCW204-USBD05-108B](#) [HYCW214-USBA04-113B](#)
[HYCW213-USBA04-113B](#) [UB-20AMFM-SL7A01](#) [KMMX-BSMT35S-1-B30TR](#) [2345986-1](#)