

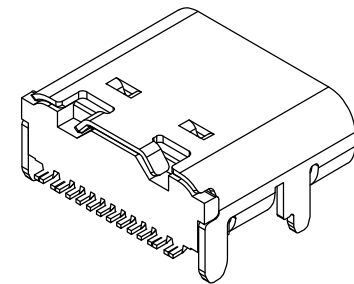

REV.	ECN NO OR DESCRIPTION	REVISED	DATE

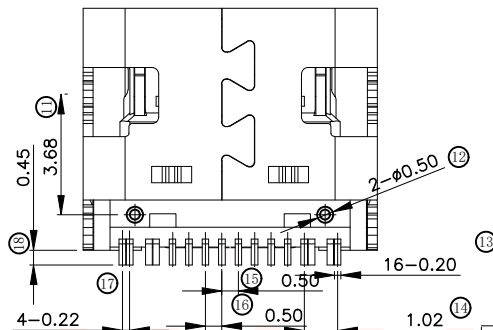
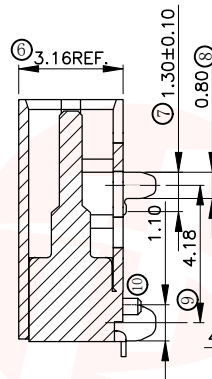
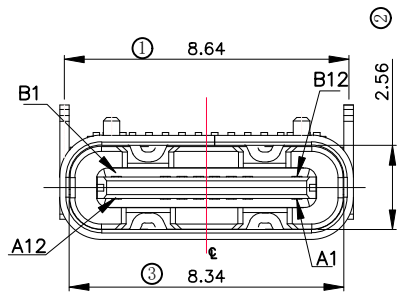

特性:

一、电气性能: ELECTRICAL

1. 额定电流: 5.0A
2. 接触阻抗: 40 MILLIOHMS MAX
3. 耐电压: 150V AC / 1 mA MAX
4. 绝缘阻抗: 150V DC/100 MEGA OHMS MIN

二、机械性能:

1. 插入力: 5~20N
2. 拨出力: 8~20N
3. 使用寿命: 10000次、拨出力 5N MIN

三、材料: MATERIAL

1. 塑胶: LCP/PA9T UL94V-0
2. 端子: C7025/C18400 T=0.15MM
3. 外壳: SUS304 T=0.30MM
4. 卡勾: SUS304 T=0.20MM

四、电镀: FINISH

1. 端子: 接触点镀金3U"MIN
PIN脚焊接区域镀金1U"MIN.
2. 外壳: 镀镍50U"MIN (盐雾48H)

五、电镀品需做粘锡测试: 粘锡面积达到95%以上。

六、SMT回流焊 (峰值260° C ± 5° C) 不能起泡、熔胶、变色不良 (变形在公差范围以内)

七、工作温度: -40° C ~ +85° C

A1	GND	B12	GND
A4	VBUS	B9	VBUS
A5	CC1	B8	SBU2
A6	D+	B7	D-
A7	D-	B6	D+
A8	SBU1	B5	CC2
A9	VBUS	B4	VBUS
A12	GND	B1	GND
PIN	SIGNAL NAME	PIN	SIGNAL NAME

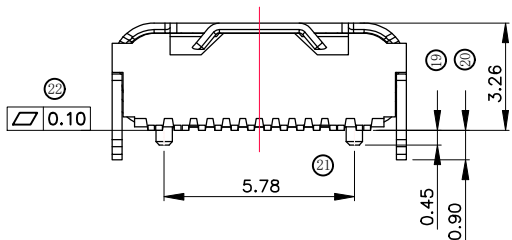
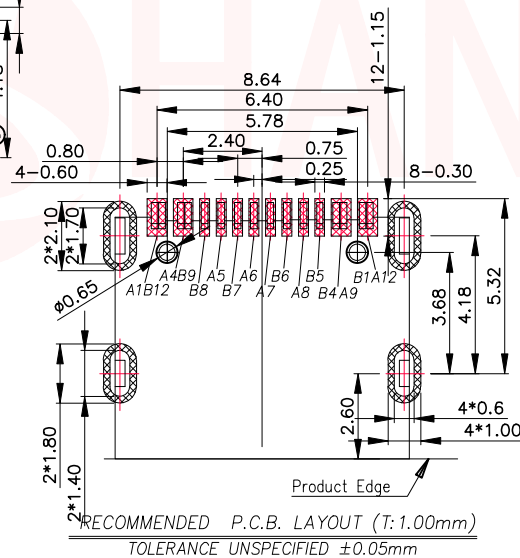

UNLESS OTHERWISE SPECIFIED TOLERANCES

DECIMALS: ANGLES:

X ±0.50 X ±2°

X.X ±0.25 X.X ±1°

X.XX ±0.15

东莞市汉博电子科技有限公司 DONGGUAN HANBO TECHNOLOGY CO., LTD	
TITLE	TYPE C 16PIN 母座 板上SMT 外壳四脚插板无弹
DWN	xiong PART NO. MC-107DDS
CHKD	lee SCALE:1:1 UNIT: mm
APVD	wang SIZE: A4 SHEET:1OF 1 REV: A4
CUSTOMER COPY	



REV.	ECN NO OR DESCRIPTION	REVISED	DATE

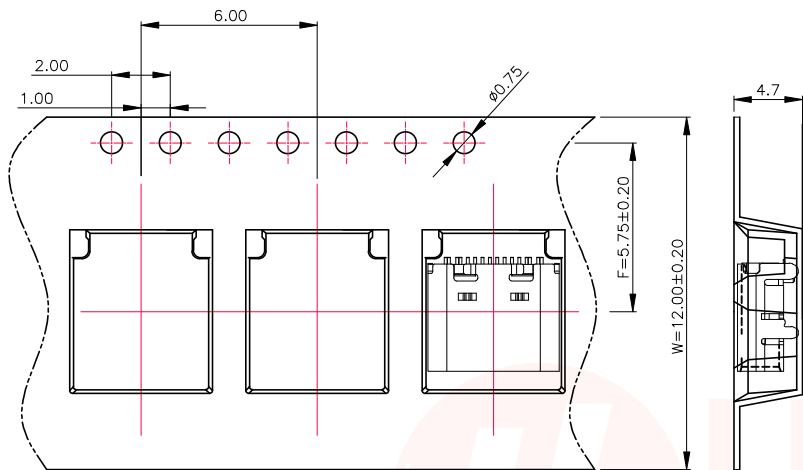

① 产品入载带示意图

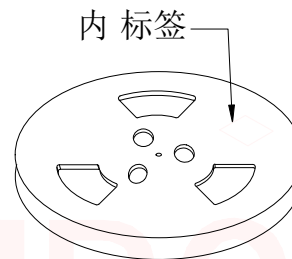

② 卷盘贴标签示意图

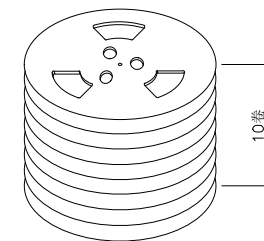

③ 10盘产品叠层示意图

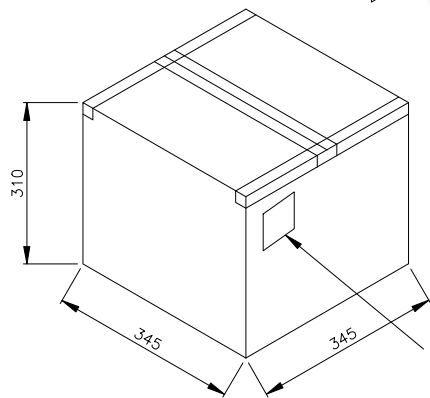

⑤ 外箱封箱示意图

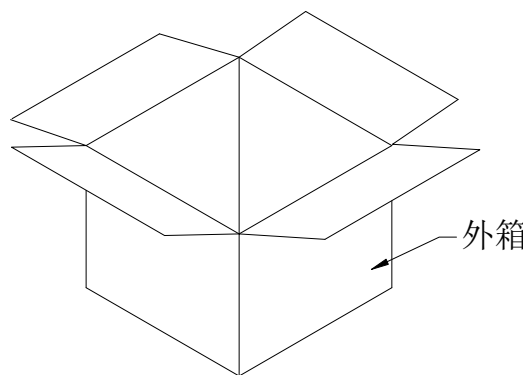

④ 产品入外箱示意图

包装说明:

1. 将检验好的成品;对插口朝前放入载带;每卷装1000PCS产品;具体如图一所示
2. 将包装好的产品;每盘必需贴上内标签;具体如图二所示
3. 将贴好内标签的产品每10盘叠;具体如图三所示
4. 装好后并封好纸箱及贴好相关标签;具体如图五所示;
(产品包装的标签,如客户有要求,请按客户要求包装出货)
5. 载带前面留10PCS空格,后面留10PCS空格
6. COVER与CARRY剥离力:50-125g,速度:300mm/分钟左右,剥离角度:165°-180°

UNLESS OTHERWISE SPECIFIED TOLERANCES

DECIMALS:	ANGLES:
X :±0.50	X :±2°
X.X :±0.25	X.X :±1°
X.XX :±0.15	



东莞市汉博电子科技有限公司
DONGGUAN HANBO TECHNOLOGY CO., LTD

TITLE	TYPE C 16PIN 母座 板上SMT 外壳四脚插板无弹			
DWN	xiong	PART NO.	MC-107DDS	
CHKD	lee	SCALE:1:1	UNIT: mm	
APVD	wang	SIZE: A4	SHEET:10F 1	REV: A4

CUSTOMER COPY

X-ON Electronics

Largest Supplier of Electrical and Electronic Components

Click to view similar products for [USB Connectors](#) category:

Click to view products by [Hanbo Electronic](#) manufacturer:

Other Similar products are found below :

[950](#) [A-USB B-TOP-C](#) [MUSBA511N5](#) [MUSBC111M5](#) [MUSBD11135](#) [17-200721](#) [217450-1](#) [KMBVX-TH-5S-B30](#) [896-30-004-00-000000](#)
[KUSBX-AS2N-W](#) [KUSBX-SMT2AP1S-W30](#) [935](#) [957](#) [30-498-6](#) [SK-60A-2](#) [1734082-1](#) [30-1574](#) [30-470](#) [30-489](#) [30-541](#) [A-USB A-2P-C](#)
[MIKROE-1451](#) [USBFTV2PEM2G](#) [USBFTVSCCG](#) [4689-1](#) [1-1734084-2](#) [MUSBC11135](#) [USBF21ZNSCC](#) [USBBFTV6ZC](#) [MUSBB151341](#)
[10135326-001LF](#) [M9177/3-1](#) [TJ-105](#) [USB-A-S-F-B-VT](#) [4198](#) [690-024-633-031](#) [UB-20PMFP-LC7001](#) [USBFTVC6MRG](#) [UA-20BMFA-](#)
[SL8001](#) [17-200011](#) [USBFTVC7ZC](#) [UB-20AFMM-LL7A01](#) [USBFTVC2MN](#) [CAP-WCCMLPB1](#) [1310-1031-01](#) [2041386-1](#) [2274475-3](#) [UB-](#)
[20BMFA-SL8001](#) [UB-20PMFP-SC8003](#) [914-614A2025S10200](#)