

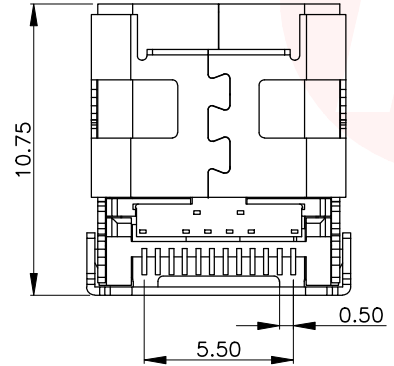

REV.	ECN NO OR DESCRIPTION	REVISED	DATE

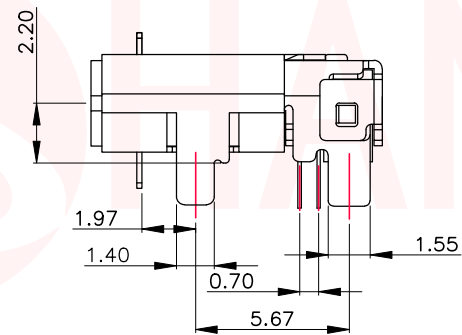
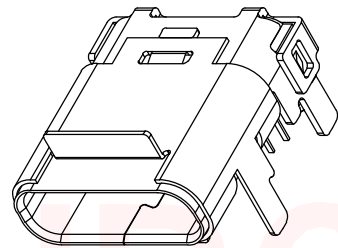
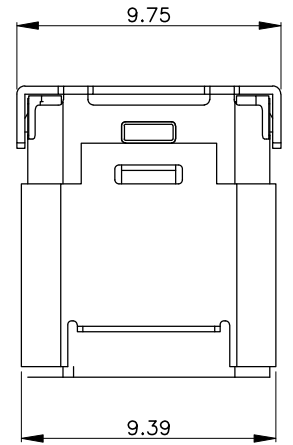
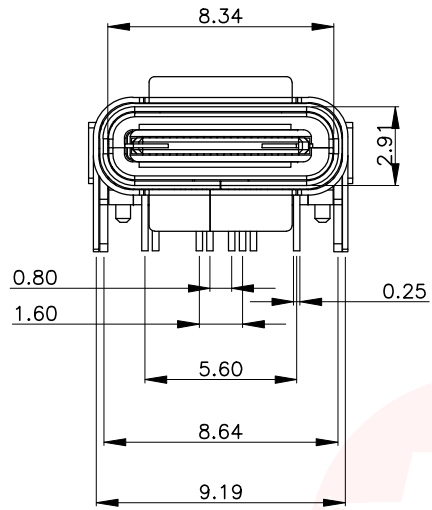

A1	GND	B12	GND
A2	SSTXP1	B11	SSRXP1
A3	SSTXN1	B10	SSRXN1
A4	VBUS	B9	VBUS
A5	CC1	B8	SBU2
A6	DP1	B7	DN2
A7	DN1	B6	DP2
A8	SBU1	B5	CC2
A9	VBUS	B4	VBUS
A10	SSRXN2	B3	SSTXN2
A11	SSRXP2	B2	SSTXP2
A12	GND	B1	GND
PIN	SIGNAL NAMF	PIN	SIGNAL NAMF

备注:

1. 材质:
 - 1.1 胶芯: LCP+30%G.F
 - 1.2 端子: C1814, T=0.12mm; 镍底, 镀金
 - 1.3 外壳: 不锈钢, T=0.30mm; 表面镀镍
 - 1.4 外套: 不锈钢, T=0.20mm; 表面镀镍
 - 1.5 接地片: 不锈钢, T=0.10mm;
 - 1.6 卡片: 不锈钢, T=0.15mm;
2. 主要特性:
 - 2.1 额定电流: 3A FOR VBUS;
1.25A FOR GND;
0.25A FOR OTHER.
 - 2.2 接触阻抗: 40mΩ MAX
 - 2.3 绝缘阻抗: 100MΩ MIN
 - 2.4 耐压测试: 100V AC
 - 2.5 沾锡性: 温度245±5℃, 时间5±0.5s
 - 2.6 整体插入力: 5~20N
整体拔出力: 8~20N
耐久后拔出力: 6~20N
 - 2.7 使用寿命: 10000次
 - 2.8 工作温度: -25℃~+80℃

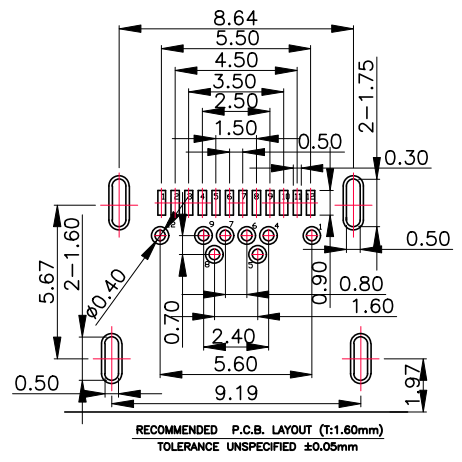
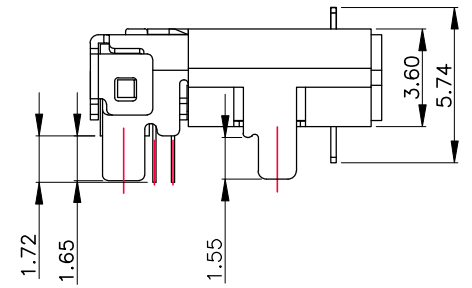

UNLESS OTHERWISE SPECIFIED TOLERANCES

DECIMALS: ANGLES:

X ±0.30 X ±2°

X.X ±0.20 X.X ±1°

X.XX ±0.10

东莞市汉博电子科技有限公司
DONGGUAN HANBO TECHNOLOGY CO., LTD

TITLE	TYPE C/F 板上中心高2.2 有缺口 缺PIN		
DWN	xiong	PART NO. MC-262	
CHKD	lee	SCALE:1:1	UNIT: mm
APVD	wang	SIZE: A4	SHEET:10F 1
REV: A4			

CUSTOMER COPY

X-ON Electronics

Largest Supplier of Electrical and Electronic Components

Click to view similar products for [USB Connectors](#) category:

Click to view products by [Hanbo Electronic](#) manufacturer:

Other Similar products are found below :

[950](#) [A-USB A-LP-SMT-C](#) [A-USB B-TOP-C](#) [MUSBD11135](#) [17-200721](#) [217450-1](#) [KMBVX-TH-5S-B30](#) [KUSBX-AS2N-W](#) [KUSBX-SMT2AP1S-W30](#) [935](#) [957](#) [30-498-6](#) [SK-60A-2](#) [1734082-1](#) [30-470](#) [30-489](#) [30-541](#) [MAB 5 S](#) [A-USB A-2P-C](#) [MIKROE-1451](#)
[USBFTVSCCG](#) [1-1734084-2](#) [MUSBA81130](#) [NK-27-32SL](#) [NK-L8-22C-5/8](#) [10135326-001LF](#) [4198](#) [690-024-633-031](#) [UB-20PMFP-LC7001](#)
[17-200011](#) [UB-20AFMM-LL7A01](#) [CAP-WCCMLPB1](#) [CAP-WCCMLPC1](#) [2274475-3](#) [914-614A2025S10200](#) [USB3FTV7SAGF059](#)
[USB3FTV2SAZNF459](#) [USB3FTV7SAZNF459](#) [HYCW153-USBD05-500B](#) [HYCW219-USBD05-075B](#) [HYCW148-USBD05-117B](#)
[HYCW149-USBD05-740B](#) [HYCW204-USBD05-108B](#) [HYCW214-USBA04-113B](#) [HYCW213-USBA04-113B](#) [KMMX-BSMT35S-1-B30TR](#)
[2345986-1](#) [10082141-N340LF](#) [10117836-011LF](#) [GSB3C3133DSYHR](#)