

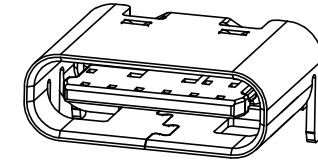

REV.	ECN NO OR DESCRIPTION	REVISED	DATE

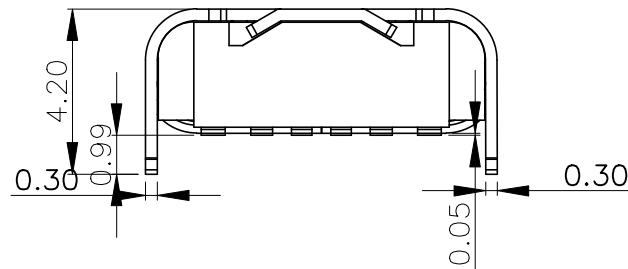
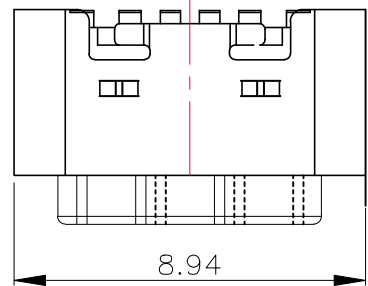

NOTE:

- 1.MATERIAL SPECIFICATION:**
 1.HOUSING:HIGH TEMPERATURE RESISTANT PLASTIC,UL94 V-0.
 2.CONTACTS:COPPER ALLOY
 3.MID PLATE: STAINLESS STEEL
 4.FRONT SHELL: STAINLESS STEEL
- 2.PLATING SPECIFICATION:**
 2-1.CONTACTS:
 Ni 50u" MIN. UNDER PLATED OVER ALL.
 Au PLATED ON THE FUNCTIONAL AREA OF CONTACT.
 (GOLD PLATING THICKNESS FOLLOW THE P/N)
 PLATING SPECIFICATIONS OF THE SOLDER AREA FOLLOW THE P/N
- 2-2.FRONT SHELL:
 SEE TABLE1.
- 2-3.SHIELD PLATE&EMI PLATE:
 CLEAR ONLY
- 3.MECHANICAL PERFORMANCE,**
 3-1.INSERTION FORCE: 0.5~2.0kgf.
 3-2.REMOVAL FORCE: 0.8kgf~2.0kgf.
 3-3.DURABILITY: 5000 CYCLES.
- 4.ELECTRICAL PERFORMANCE,**
 4-1. CURRENT RATING:3.0A
 VOLTAGE RATING:5.0V
- 4-2. LLCR:
 VBUS & GND PINS AND OTHER PINS: 40mA/PIN MAX.
 SHIELD: 50mA/MAX.
 LLCR MAX. CHANGE OF ALL PINS: 10mA.
- 4-3.INSULATION RESISTANCE: 100MΩ MIN
 4-4.DIELECTRIC WITHSTAND VOLTAGE,AC 100V FOR 1 MINUTE.
- 5. ENVIRONMENTAL PERFORMANCE:**
 OPERATING TEMPERATURE: -25°C~+85°C.
- 6.IR REFLOW:**
 THE PEAK TEMPERATURE ON THE BOARD SHALL
 BE MAINTAINED FOR 10 SECONDS AT 260°C.

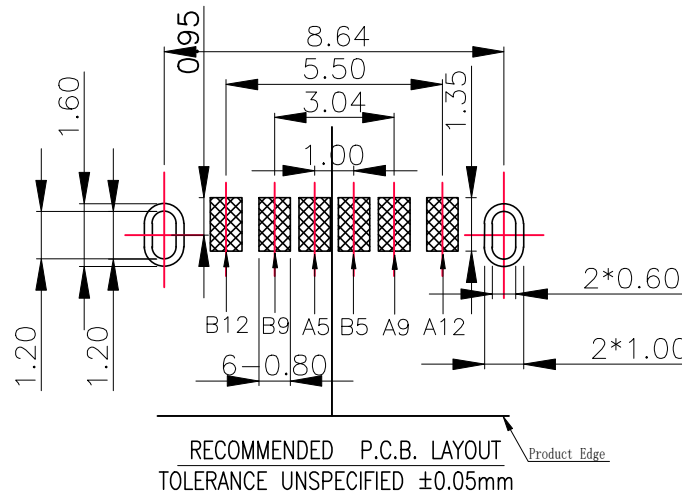
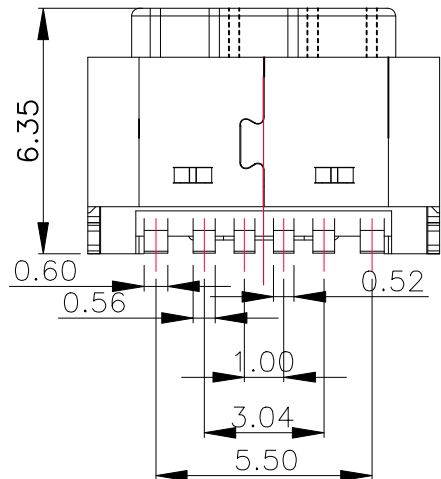
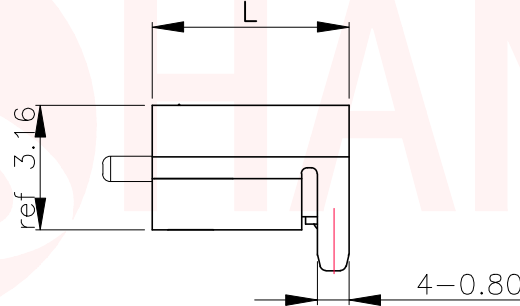
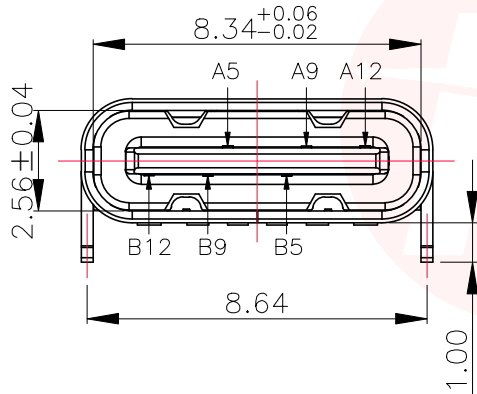

PIN ASSIGNMENTS

A5	CC1	B12	GND
A9	VBUS	B9	VBUS
A12	GND	B5	CC2
PIN	SIGNAL NAME	PIN	SIGNAL NAME

PART No.	DIM L
MC-311D-H50	5.0
MC-311D-H55	5.5
MC-311D-H65	6.5
MC-311D-H68	6.8

UNLESS OTHERWISE SPECIFIED TOLERANCES

DECIMALS: X :±0.30 X.X :±0.20 X.XX :±0.10
 ANGLES: X :±2° X.X :±1°



东莞市汉博电子科技有限公司
 DONGGUAN HANBO TECHNOLOGY CO., LTD

TITLE	TYPE C 6P 板上后两脚插板SMT			
DWN	xiong	PART NO.	MC-311D-HXXX	
CHKD	lee	SCALE:1:1	UNIT: mm	
APVD	wang	SIZE: A4	SHEET:1OF 1	REV: A4

CUSTOMER COPY



REV.	ECN NO OR DESCRIPTION	REVISED	DATE

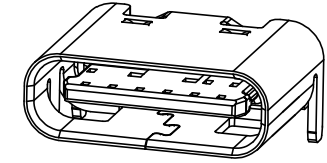

NOTE:

- MATERIAL SPECIFICATION:**
 - HOUSING: HIGH TEMPERATURE RESISTANT PLASTIC, UL94 V-0.
 - CONTACTS: COPPER ALLOY
 - MID PLATE: STAINLESS STEEL
 - FRONT SHELL: STAINLESS STEEL
- PLATING SPECIFICATION:**
 - CONTACTS: Ni 50u" MIN. UNDER PLATED OVER ALL. Au PLATED ON THE FUNCTIONAL AREA OF CONTACT. (GOLD PLATING THICKNESS FOLLOW THE P/N) PLATING SPECIFICATIONS OF THE SOLDER AREA FOLLOW THE P/N
- FRONT SHELL:** SEE TABLE 1.
- SHIELD PLATE & EMI PLATE:** CLEAR ONLY
- MECHANICAL PERFORMANCE:**
 - INSERTION FORCE: 0.5~2.0kgf.
 - REMOVAL FORCE: 0.8kgf~2.0kgf.
 - DURABILITY: 5000 CYCLES.
- ELECTRICAL PERFORMANCE:**
 - CURRENT RATING: 3.0A VOLTAGE RATING: 5.0V
 - LLCR: VBUS & GND PINS AND OTHER PINS: 40ma/PIN MAX. SHIELD: 50ma/MAX. LLCR MAX. CHANGE OF ALL PINS: 10ma.
 - INSULATION RESISTANCE: 100MΩ MIN
 - DIELECTRIC WITHSTAND VOLTAGE, AC 100V FOR 1 MINUTE.
- ENVIRONMENTAL PERFORMANCE:** OPERATING TEMPERATURE: -25°C~+85°C.
- IR REFLOW:** THE PEAK TEMPERATURE ON THE BOARD SHALL BE MAINTAINED FOR 10 SECONDS AT 260°C.

PIN ASSIGNMENTS

PIN	SIGNAL NAME	PIN	SIGNAL NAME
A5	CC1	B12	GND
A9	VBUS	B9	VBUS
A12	GND	B5	CC2

PART No.	DIM L
MC-311D-H50	5.0
MC-311D-H55	5.5
MC-311D-H65	6.5
MC-311D-H68	6.8

UNLESS OTHERWISE SPECIFIED TOLERANCES



东莞市汉博电子科技有限公司
DONGGUAN HANBO TECHNOLOGY CO., LTD

DECIMALS: X :±0.30 X.X :±0.20 X.XX :±0.10
 ANGLES: X :±2° X.X :±1°

TITLE	TYPE C 6P 板上后两脚插板SMT			
DWN	xiong	PART NO.	MC-311D-HXXX	
CHKD	lee	SCALE: 1:1	UNIT: mm	
APVD	wang	SIZE: A4	SHEET: 1 OF 1	REV: A4

CUSTOMER COPY

RECOMMENDED P.C.B. LAYOUT
TOLERANCE UNSPECIFIED ±0.05mm

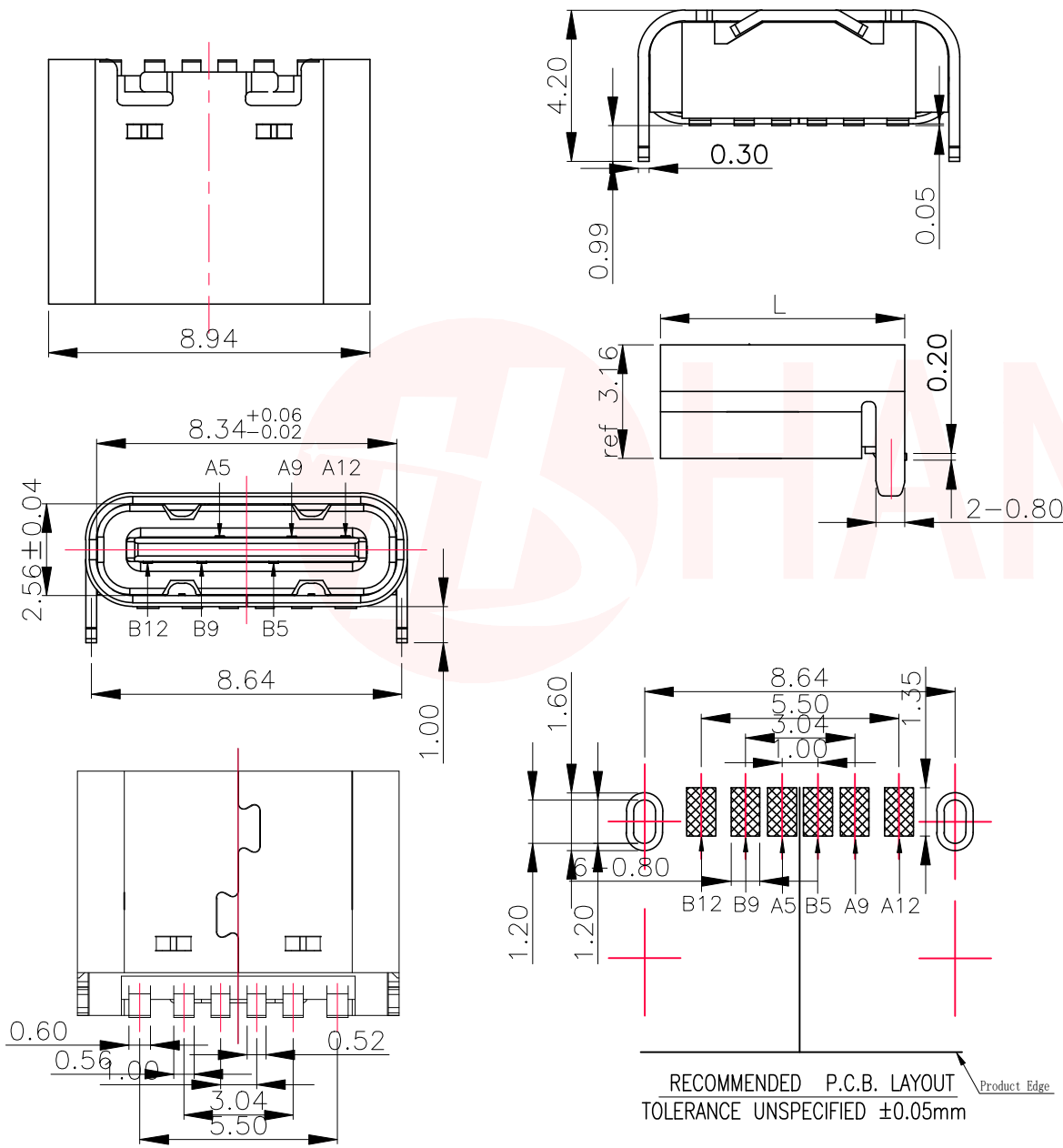

X-ON Electronics

Largest Supplier of Electrical and Electronic Components

Click to view similar products for [USB Connectors](#) category:

Click to view products by [Hanbo Electronic](#) manufacturer:

Other Similar products are found below :

[950](#) [A-USB A-LP-SMT-C](#) [A-USB B-TOP-C](#) [MUSBD11135](#) [17-200721](#) [217450-1](#) [KMBVX-TH-5S-B30](#) [KUSBX-AS2N-W](#) [KUSBX-SMT2AP1S-W30](#) [935](#) [957](#) [30-498-6](#) [SK-60A-2](#) [1734082-1](#) [30-470](#) [30-489](#) [30-541](#) [MAB 5 S](#) [A-USB A-2P-C](#) [MIKROE-1451](#)
[USBFTVSCCG](#) [1-1734084-2](#) [MUSBA81130](#) [NK-27-32SL](#) [NK-L8-22C-5/8](#) [10135326-001LF](#) [4198](#) [690-024-633-031](#) [UB-20PMFP-LC7001](#)
[17-200011](#) [UB-20AFMM-LL7A01](#) [CAP-WCCMLPB1](#) [CAP-WCCMLPC1](#) [2274475-3](#) [914-614A2025S10200](#) [USB3FTV7SAGF059](#)
[USB3FTV2SAZNF459](#) [USB3FTV7SAZNF459](#) [HYCW153-USBD05-500B](#) [HYCW219-USBD05-075B](#) [HYCW148-USBD05-117B](#)
[HYCW149-USBD05-740B](#) [HYCW204-USBD05-108B](#) [HYCW214-USBA04-113B](#) [HYCW213-USBA04-113B](#) [KMMX-BSMT35S-1-B30TR](#)
[2345986-1](#) [10082141-N340LF](#) [10117836-011LF](#) [GSB3C3133DSYHR](#)