

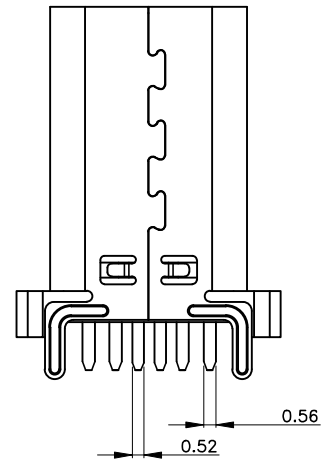

REV.	ECN NO OR DESCRIPTION	REVISED	DATE

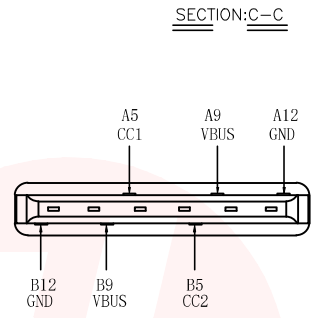
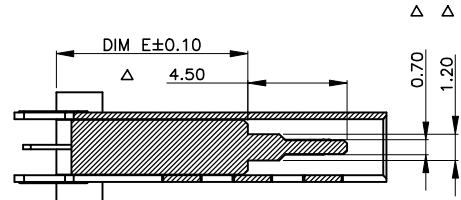
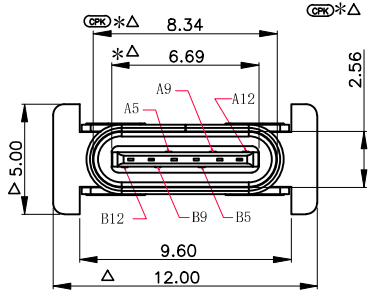

- NOTE1:
- MATERIAL SPECIFICATION:
    - HOUSING: HIGH TEMPERATURE RESISTANT PLASTIC, UL94 V-0.
    - CONTACTS: COPPER ALLOY
    - MID PLATE: STAINLESS STEEL
    - FRONT SHELL: STAINLESS STEEL
  - PLATING SPECIFICATION:
    - CONTACTS: Ni 50u" MIN. UNDER PLATED OVER ALL. Au PLATED ON THE FUNCTIONAL AREA OF CONTACT. (GOLD PLATING THICKNESS FOLLOW THE P/N) PLATING SPECIFICATIONS OF THE SOLDER AREA FOLLOW THE P/N
  - MECHANICAL PERFORMANCE,
    - INSERTION FORCE: 0.5~2.0kgf.
    - REMOVAL FORCE: 0.8kgf~2.0kgf.
    - DURABILITY: 2000 CYCLES.
  - ELECTRICAL PERFORMANCE,
    - CURRENT RATING: 3.0A VOLTAGE RATING: 5.0V
    - LLCR: VBUS & GND PINS AND OTHER PINS: 40mA/PIN MAX. SHIELD: 50mA/MAX. LLCR MAX. CHANGE OF ALL PINS: 10mA.
    - INSULATION RESISTANCE: 100MΩ MIN
    - DIELECTRIC WITHSTAND VOLTAGE, AC 100V FOR 1 MINUTE.
  - ENVIRONMENTAL PERFORMANCE: OPERATING TEMPERATURE: -25°C~+85°C.
  - IR REFLOW: THE PEAK TEMPERATURE ON THE BOARD SHALL BE MAINTAINED FOR 10 SECONDS AT 260°C.
  - COMPLY WITH RoHS 2.0 AND REACH AND OTHER ENVIRONMENTAL PROTECTION REQUIREMENTS
  - 带"Δ"符号为重点管控尺寸  
带"\*"符号为巡检管控尺寸  
带"CPK"符号为CPK管控尺寸

NOTE2:

DIM D	DIM E	DIM F	PART No.
10.00	5.00	7.90	MC-330ZC-H100
10.50	5.00	8.40	MC-330ZC-H105
11.50	6.40	9.40	MC-330ZC-H115
13.00	8.70	10.90	MC-330ZC-H130
13.70	8.70	11.60	MC-330ZC-H137
15.00	8.70	12.90	MC-330ZC-H150

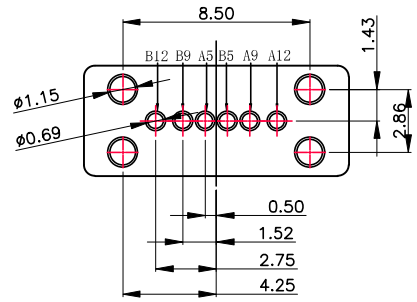
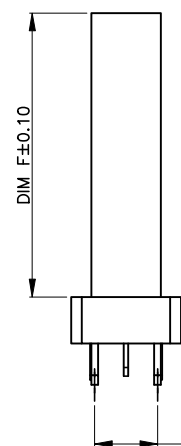
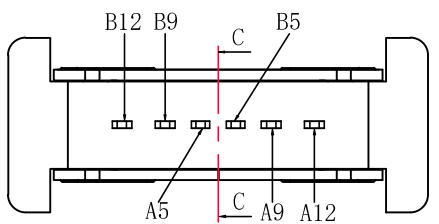
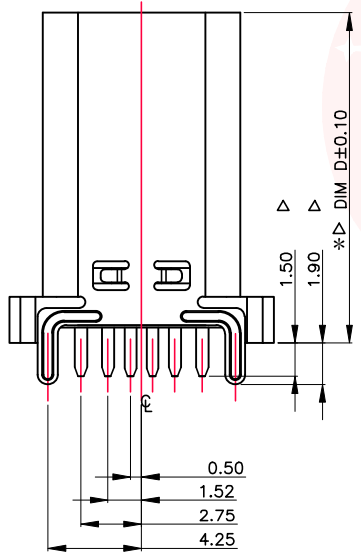
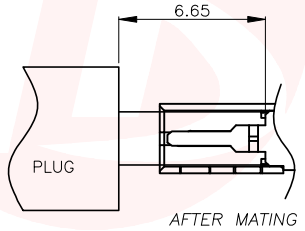

RECOMMENDED P.C.B. LAYOUT  
TOLERANCE UNSPECIFIED ±0.05mm

USB TYPE-C PIN ASSIGNMENTS

PIN NUMBER	SIGNAL NAME	PIN NUMBER	SIGNAL NAME
A12	GND	B12	GND
A9	VBUS	B9	VBUS
A5	CC1	B5	CC2

UNLESS OTHERWISE SPECIFIED TOLERANCES

DECIMALS: X ±0.35 X.X ±0.25 X.XX ±0.15

ANGLES: X ±2° X.X ±1°

TITLE: 6PIN TYPE C 立插母座 L=10.0-15.0

DWN: xiong PART NO. MC-330ZC-HXXX

CHKD: lee SCALE: 1:1 UNIT: mm

APVD: wang SIZE: A4 SHEET: 1 OF 1 REV: A4

CUSTOMER COPY

东莞市汉博电子科技有限公司  
DONGGUAN HANBO TECHNOLOGY CO., LTD

## X-ON Electronics

Largest Supplier of Electrical and Electronic Components

*Click to view similar products for [USB Connectors](#) category:*

*Click to view products by [Hanbo Electronic](#) manufacturer:*

Other Similar products are found below :

[950](#) [A-USB A-LP-SMT-C](#) [A-USB B-TOP-C](#) [MUSBD11135](#) [17-200721](#) [217450-1](#) [KMBVX-TH-5S-B30](#) [KUSBX-AS2N-W](#) [KUSBX-SMT2AP1S-W30](#) [935](#) [957](#) [30-498-6](#) [SK-60A-2](#) [1734082-1](#) [30-470](#) [30-489](#) [30-541](#) [MAB 5 S](#) [A-USB A-2P-C](#) [MIKROE-1451](#)  
[USBFTVSCCG](#) [1-1734084-2](#) [MUSBA81130](#) [NK-27-32SL](#) [NK-L8-22C-5/8](#) [10135326-001LF](#) [4198](#) [690-024-633-031](#) [UB-20PMFP-LC7001](#)  
[17-200011](#) [UB-20AFMM-LL7A01](#) [CAP-WCCMLPB1](#) [CAP-WCCMLPC1](#) [2274475-3](#) [914-614A2025S10200](#) [USB3FTV7SAGF059](#)  
[USB3FTV2SAZNF459](#) [USB3FTV7SAZNF459](#) [HYCW153-USBD05-500B](#) [HYCW219-USBD05-075B](#) [HYCW148-USBD05-117B](#)  
[HYCW149-USBD05-740B](#) [HYCW204-USBD05-108B](#) [HYCW214-USBA04-113B](#) [HYCW213-USBA04-113B](#) [KMMX-BSMT35S-1-B30TR](#)  
[2345986-1](#) [10082141-N340LF](#) [10117836-011LF](#) [GSB3C3133DSYHR](#)