

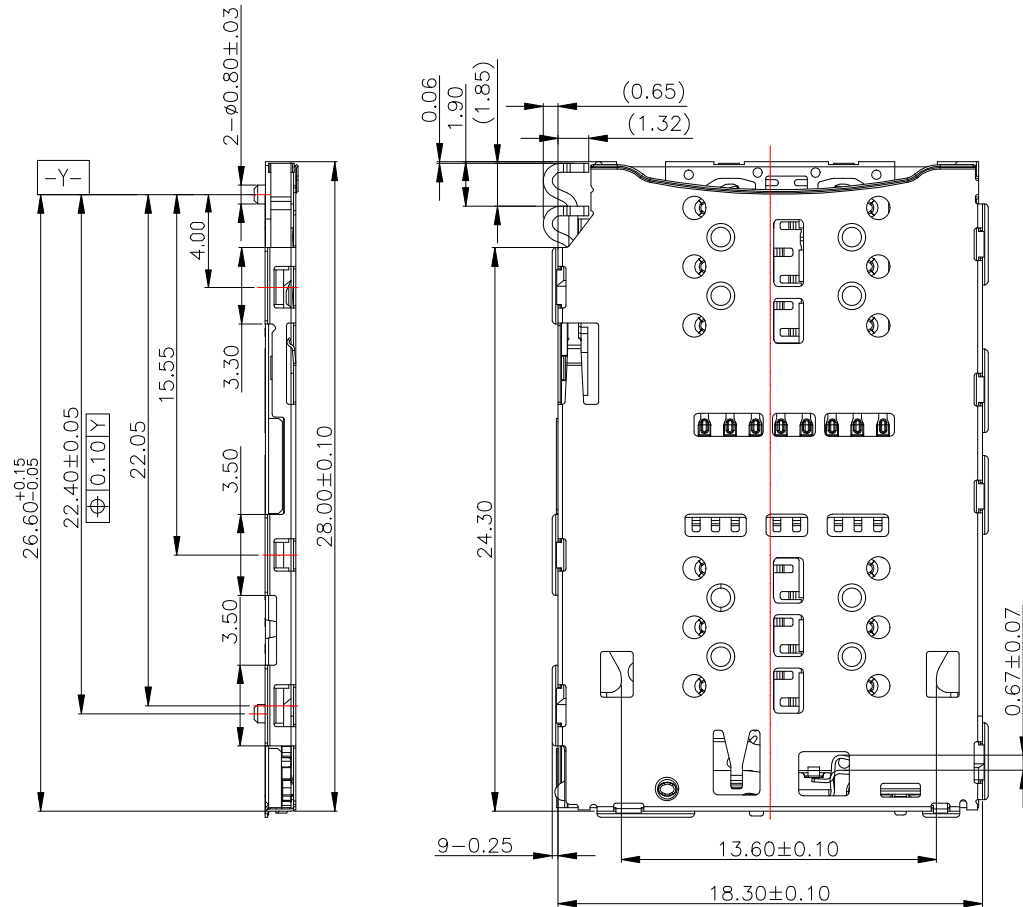

REV.	ECN NO OR DESCRIPTION	REVISED	DATE

NOTES:

- 1.) PRODUCT SPECIFICATIONS:  
 VOLTAGE RATING: 10V  
 CURRENT RATING: 0.3A  
 INSULATION RESISTANCE: 1000 MEG.OHM MIN  
 CONTACT RESISTANCE: INITIAL 50mΩ Max;AFTER TEST ΔR=25mΩ  
 OPERATION TEMPERATURE: -40° TO +85°  
 DURABILITY: 3000 CYCLES

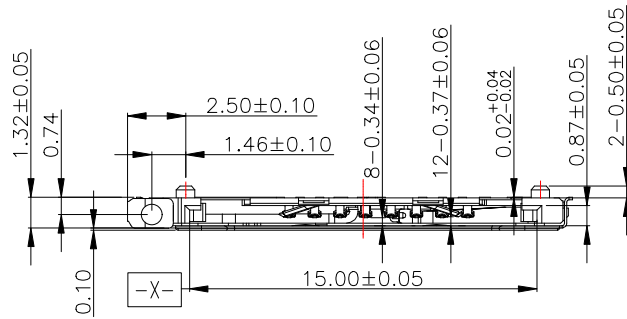

ITEM	NAME	MATERIAL	Q'TY	REMARK
8	HOOK	THERMOPLASTIC UL94 V-0	2	NO PLATING, BLACK MOISTURE PROOF GRADE:2a
7	DETECT SWITCH	COPPER ALLOY	1	15u"Min Au PLATING ON CONTACT AREA, 3u"Min Au PLATING ON SOLDER TAILS, Ni UNDERPLATING OVERALL
6	DETECT LEVER	COPPER ALLOY	1	
5	EJECT LEVER	STAINLESS STEEL	1	NO PLATING
4	EJECT BAR	STAINLESS STEEL	1	NO PLATING
3	SHELL	STAINLESS STEEL	1	3u"Min Au PLATING ON SOLDER TAILS, Ni UNDERPLATING OVER ALL
2	CONTACT	COPPER ALLOY	1	Au PLATING ON CONTACT AREA(SEE P/N) 3u"Min Au PLATING ON SOLDER TAILS, Ni UNDERPLATING OVER ALL
1	HOUSING	THERMOPLASTIC UL94 V-0	1	BLACK COLOR, MOISTURE PROOF GRADE:2c

UNLESS OTHERWISE SPECIFIED TOLERANCES		东莞市汉博电子科技有限公司 DONGGUAN HANBO TECHNOLOGY CO., LTD			
DECIMALS:	ANGLES:	TITLE 1.35H 3选2 卡座 FOR CUSTOMER			
X :±0.25	X :±5°	DWN	xiong	PART NO. MCS-102	
X.X :±0.15	X.X :±3°	CHKD	lee	SCALE:1:1	UNIT: mm
X.XX :±0.05		APVD	wang	SIZE: A4	SHEET:1OF 1
CUSTOMER COPY					



REV.	ECN NO OR DESCRIPTION	REVISED	DATE

A

B

C

D

A

B

C

D

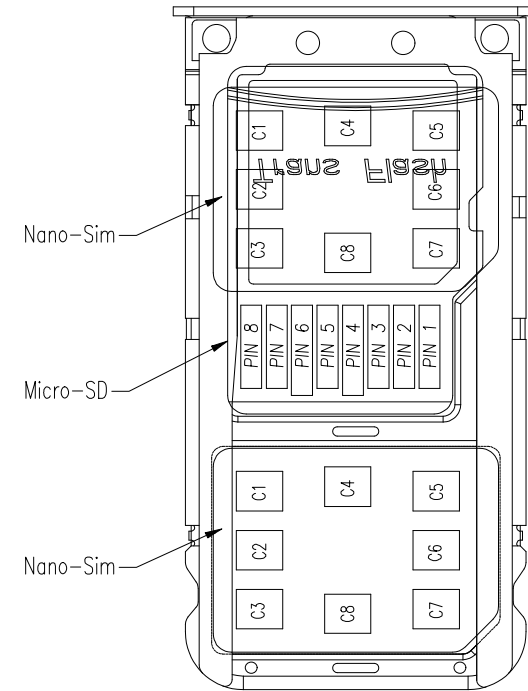
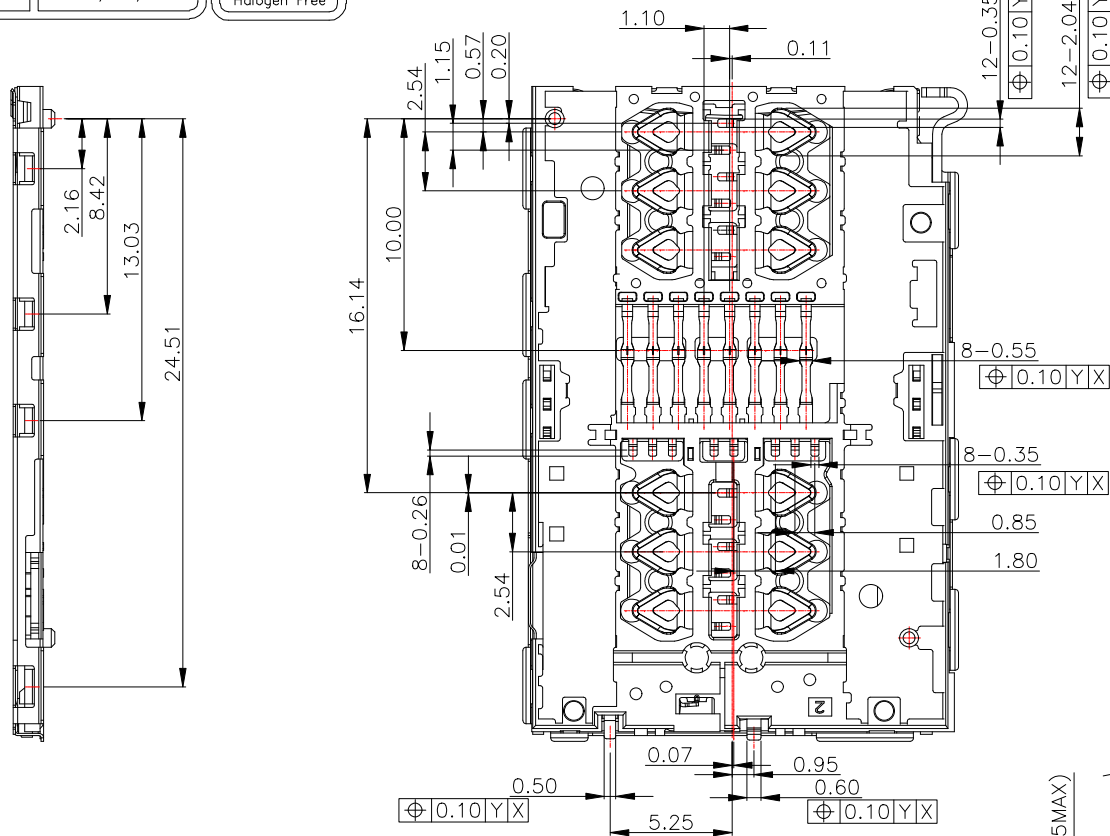

BOTTOM VIEW

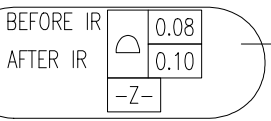
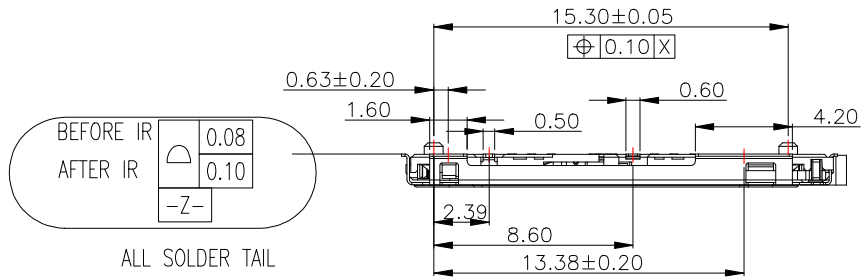
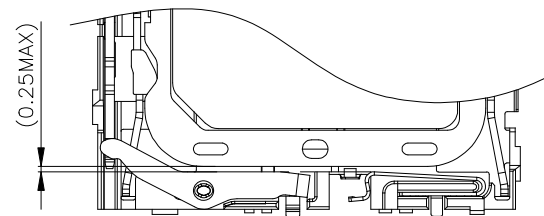

ALL SOLDER TAIL

UNLESS OTHERWISE SPECIFIED TOLERANCES		<b>东莞市汉博电子科技有限公司</b> DONGGUAN HANBO TECHNOLOGY CO., LTD		
TITLE	1.35H 3选2 卡座 FOR CUSTOMER			
DWN	xiong	PART NO. MCS-102		
CHKD	lee	SCALE:1:1	UNIT: mm	
APVD	wang	SIZE: A4	SHEET:10F 1	REV: A4
CUSTOMER COPY				

1

2

3

4

5

6



REV.	ECN NO OR DESCRIPTION	REVISED	DATE

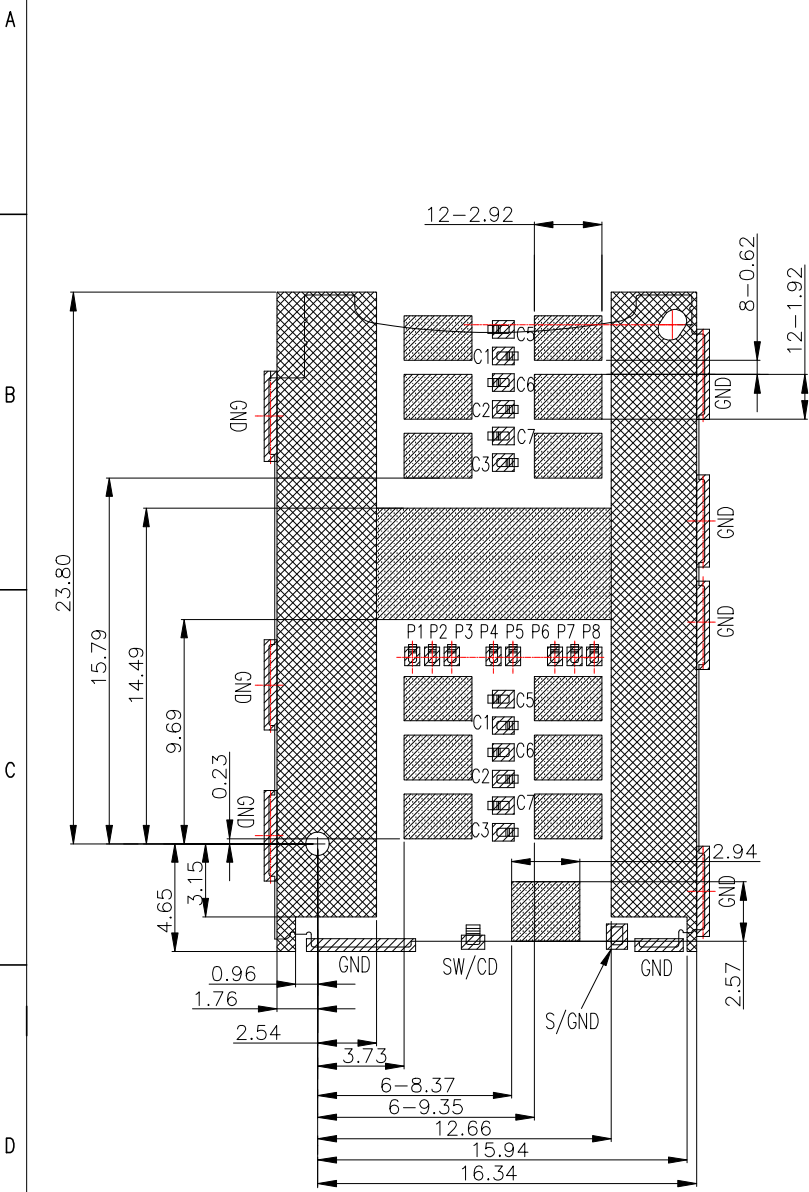

ON BOARD LOCATION

- Through Hole
  - ▨ Soldering Pad Area
  - ▩ Open Wire Restricted Area  
(Possibility Touch Of Components On PCB)
  - ▧ No Soldering Pad Area (Independent Pad Area)  
OR Open Wire & Copper Restricted Area
- 1: Touch area of contact tips, No electrical function and only for mechanical function.  
2: No first PCB-Layout circuits in the area.

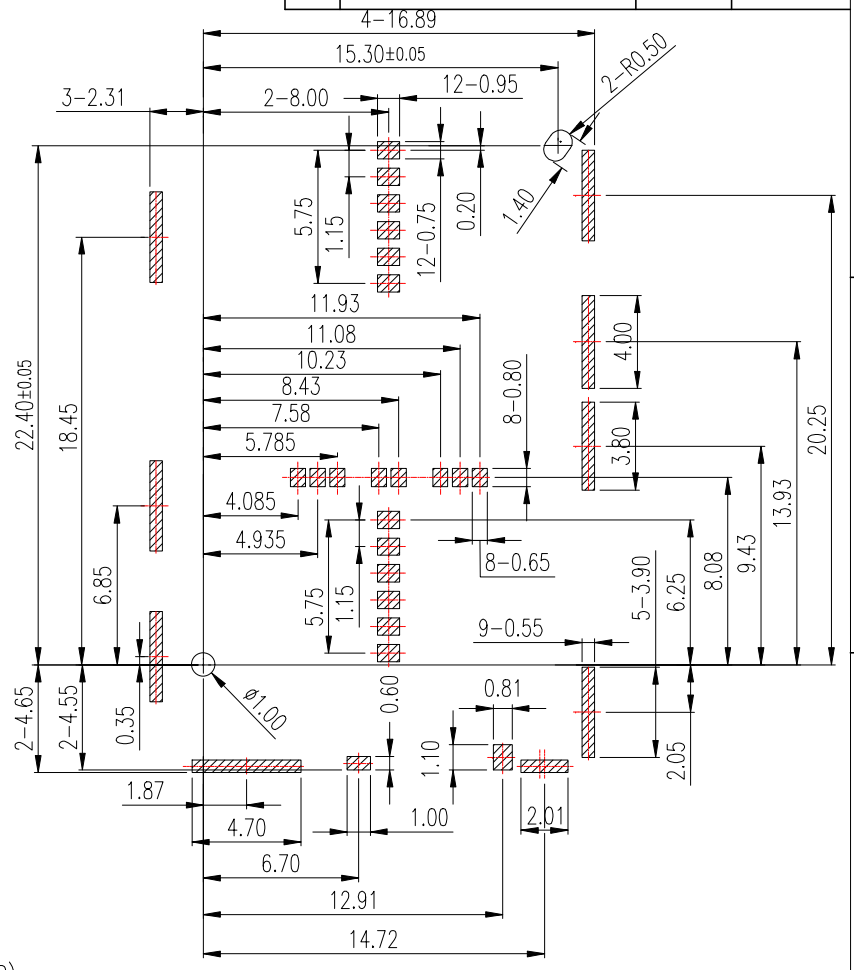

PCB LAYOUT TOLERANCE: ±0.05  
METAL MASK THICKNESS: 0.10MM

UNLESS OTHERWISE SPECIFIED TOLERANCES		东莞市汉博电子科技有限公司 DONGGUAN HANBO TECHNOLOGY CO., LTD		
DECIMALS:	ANGLES:	TITLE 1.35H 3选2 卡座 FOR CUSTOMER		
X : ±0.25	X : ±5°	DWN	xiong	PART NO. MCS-102
X.X : ±0.15	X.X : ±3°	CHKD	lee	SCALE: 1:1 UNIT: mm
X.XX : ±0.05		APVD	wang	SIZE: A4 SHEET: 1 OF 1 REV: A4
CUSTOMER COPY				



REV.	ECN NO OR DESCRIPTION	REVISED	DATE

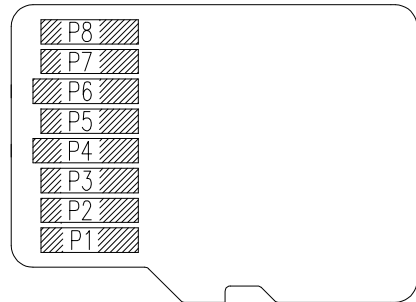
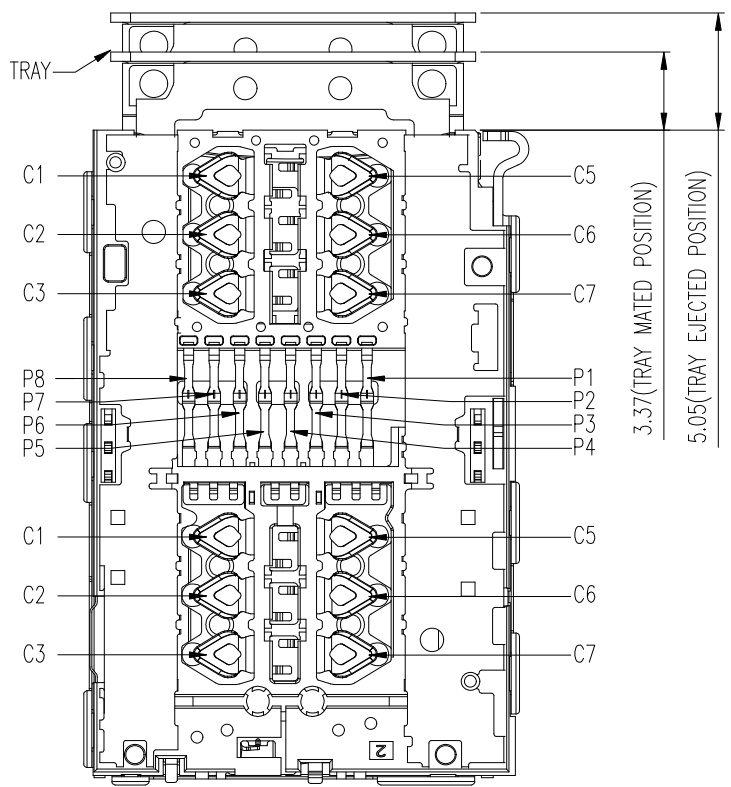

Micro SD CARD ELECTRICAL

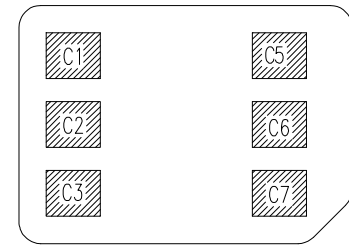

NANO SIM CARD ELECTRICAL

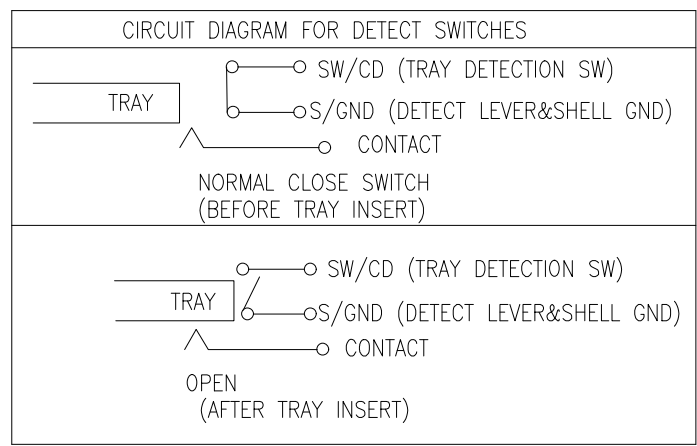
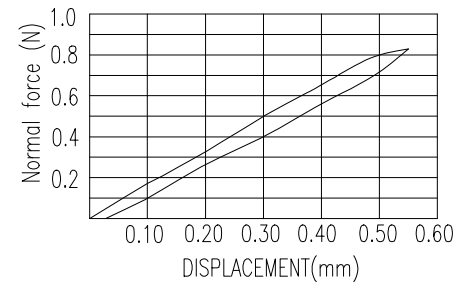
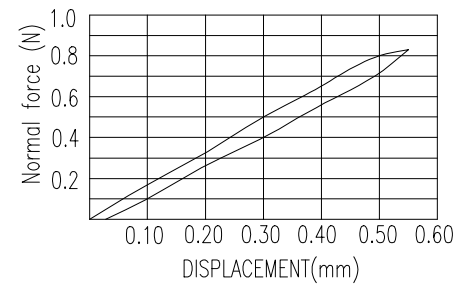
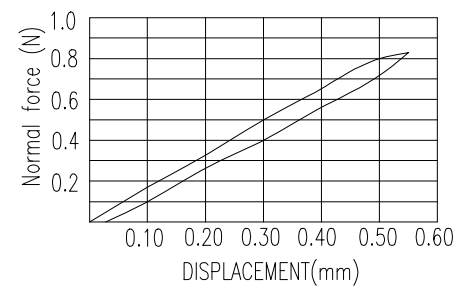

ITEM	FUNCTION
Micro SD CARD	
P1	DAT2 OF MSD
P2	CD/DAT3 OF MSD
P3	CMD OF MSD
P4	VDD OF MSD
P5	CLK OF MSD
P6	VSS OF MSD
P7	DAT0 OF MSD
P8	DAT1 OF MSD
ITEM	FUNCTION
NANO SIM CARD	
C1	VCC OF SIM
C2	RST OF SIM
C3	CLK OF SIM
C5	GND OF SIM
C6	VPP OF SIM
C7	DATA OF SIM

UNLESS OTHERWISE SPECIFIED TOLERANCES

DECIMALS: X :±0.25 X.X :±0.15 X.XX :±0.05

ANGLES: X :±5° X.X :±3°

**东莞市汉博电子科技有限公司**  
DONGGUAN HANBO TECHNOLOGY CO., LTD

**TITLE 1.35H 3选2 卡座 FOR CUSTOMER**

DWN	xiong	PART NO. MCS-102	
CHKD	lee	SCALE:1:1	UNIT: mm
APVD	wang	SIZE: A4	SHEET:1OF 1

CUSTOMER COPY

## X-ON Electronics

Largest Supplier of Electrical and Electronic Components

*Click to view similar products for [Memory Card Connectors](#) category:*

*Click to view products by [Hanbo Electronic](#) manufacturer:*

Other Similar products are found below :

[M21-033321-005](#) [6407-249V-25273P](#) [6407-249V-25343P](#) [6426-201-21343](#) [69.920.0553.0](#) [MCR60A-98D-2.54DSA\(70\)](#) [809180410000000](#)  
[DM3AT-SF-PEJM5\(41\)](#) [IC11S-BUR-PNEJL\(71\)](#) [252-0144-000](#) [2041353-2](#) [308-DS1P0811-192](#) [HM2P09PDR360N9LF](#) [10014744-011TLF](#)  
[11327-001](#) [11327-002](#) [617230001](#) [NX1-32T-KT3K\(05\)](#) [N7E50-U516RB-50-SIN0005](#) [68-580163-21S](#) [125A-78C00](#) [CCM03-3109 B LFT](#)  
[2309923-1](#) [61126-050CAHLF](#) [IC1GA-68PD-1.27DS-EJ\(72\)](#) [GTFP08432B1HR](#) [SCE2MSDZN76A121SN](#) [10014744-011ALF](#) [10014744-](#)  
[011LF](#) [10057542-1211FLF](#) [10067972-000LF](#) [10067972-050LF](#) [10122302-20110LF](#) [G85D1162022HHR](#) [MUP-C7809-1](#) [NANO SIM 7P](#)  
[H1.37](#) [MICRO SIM 7P H1.35](#) [TF-CARD H1.8 SY](#) [MICRO SIM 6P H1.35](#) [TF-CARD H1.8](#) [TF-115Y-BCP9](#) [TF-115YY-ACP9](#) [SMN-309-](#)  
[ARP6](#) [TF-115Y-ACP9](#) [TF-108-ARP10](#) [SMN-303S-ACP7](#) [SNO-14100](#) [SD-112S](#) [MUP-C7804-1](#) [KH-TF-07DT](#)