

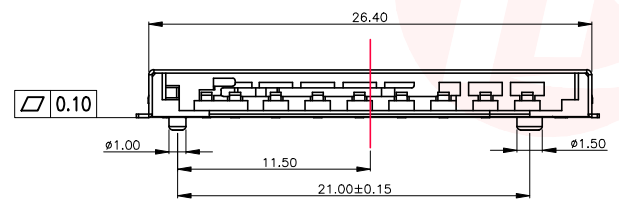

REV.	ECN NO OR DESCRIPTION	REVISED	DATE

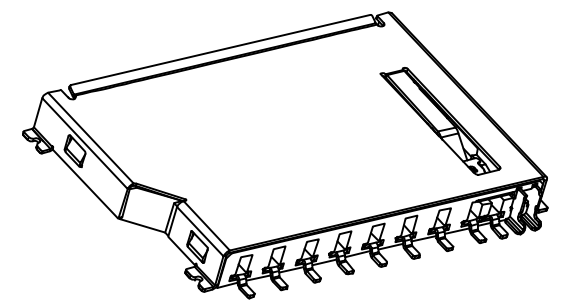
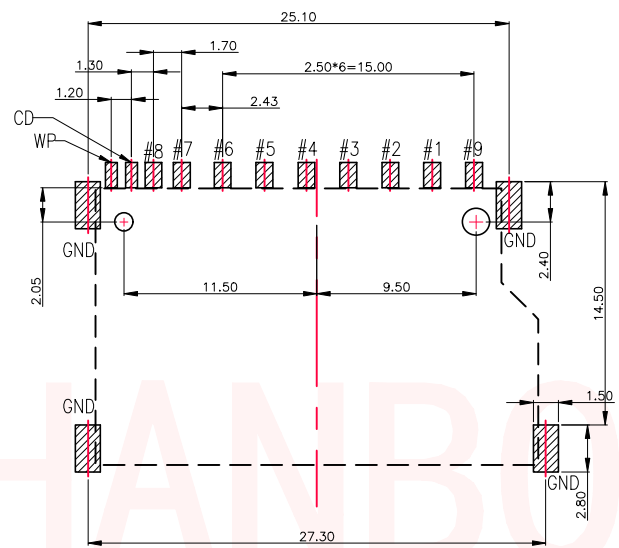
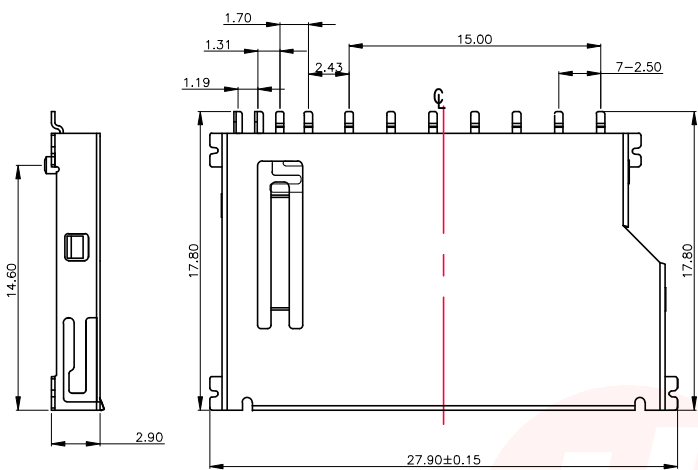

SPECIFICATION

MATERIAL

Insulator: LCP UL94V-0
 Terminal: C2680 H T:0.20mm
 Shell: C2680 H T:0.20mm

ELECTRICAL

Operation Voltage: 12 V DC Max.
 Current Rating: 0.5 Amps Max.
 Contact Resistance: 100mΩ Max.
 Insulation Resistance: 1000MΩ Min./500 VDC
 Dielectric Withstanding Voltage: 500 VAC / Minute
 Temperature Range: -25°C To +80°C

RECOMMENDED P.C.B LAYOUT (TOP VIEW)

PIN#	NAME
1	CD/DAT3
2	CMD
3	VSS1
4	VDD
5	CLK
6	VSS2
7	DAT0
8	DAT1
9	DAT2

CIRCUIT:

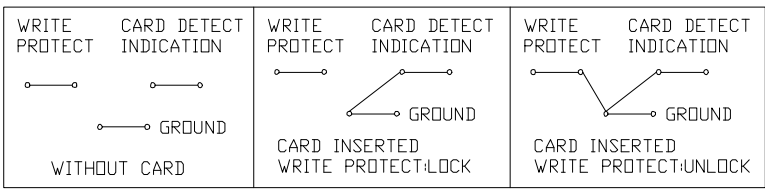

C	SHIELD	1	STAINLESS STEEL 0.20t	Ni PLATING
B	CONTACT	11	COPPER ALLOY 0.20t	Gold Flash on Contact Area Matte-Tin plated on Solder tail All over Nickel Plated .
A	HOUSING	1	THERMOPLASTIC UL94-V0	WHITE
NO	DESCRIPTION	QTY	MATERIAL	PLATING & COLOR

UNLESS OTHERWISE SPECIFIED TOLERANCES		东莞市汉博电子科技有限公司 DONGGUAN HANBO TECHNOLOGY CO., LTD			
TITLE	SD CARD CONN SHORT BODY SMT				
DWN	xiong	SD-112S			
CHKD	lee	SCALE:1:1	UNIT: mm		
APVD	wang	SIZE: A4	SHEET:10F 1	REV: A4	
CUSTOMER COPY					



REV.	ECN NO OR DESCRIPTION	REVISED	DATE

THE PACKING FOR SD CARD SERIES PUSH TYPE

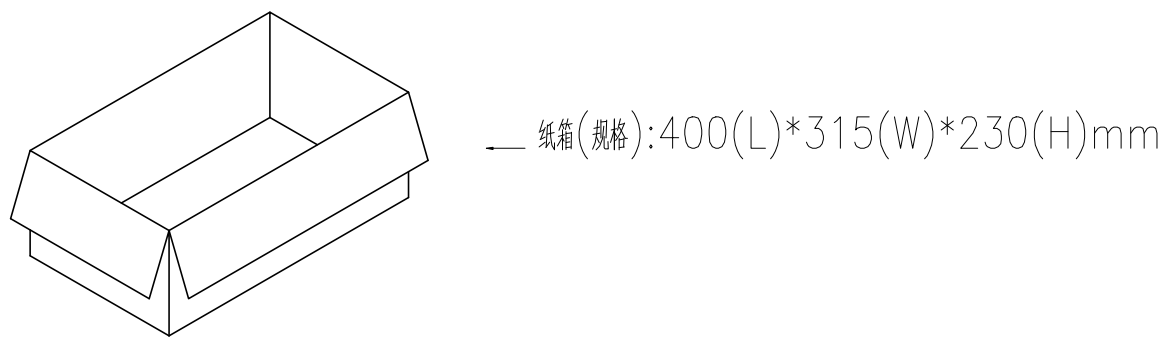
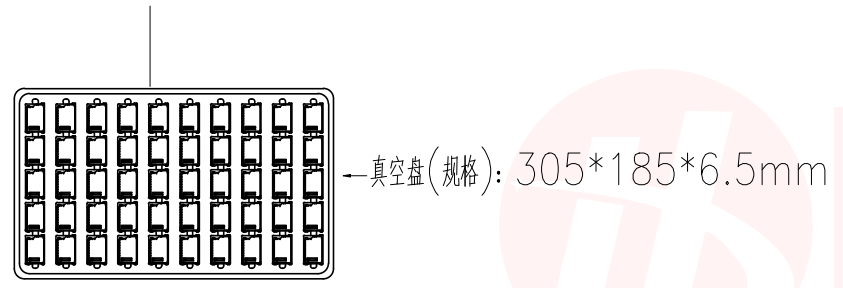
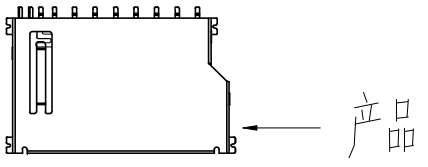

注意 (Note):

1. 将产品一一放入真空盒内, 依同一方向摆放
2. 产品放置时, 如图所示
3. 每个真空盘装入50pcs 产品
4. 一个纸箱可放入102个真空盘
5. 最上面一个真空盘用作上盖, 不装入产品
6. 一个纸箱可装入5000 PCS产品
7. 若有未装满之尾数箱, 必须用缓冲材加满
8. 装满产品之纸箱, 最大堆积数量为5箱

C	SHIELD	1	STAINLESS STEEL 0.20t	Ni PLATING
B	CONTACT	11	COPPER ALLOY 0.20t	Gold Flash On Contact Area Matte-Tin plated on Solder tail All over Nickel Plated .
A	HOUSING	1	THERMOPLASTIC UL94-V0	WHITE
NO	DESCRIPTION	QTY	MATERIAL	PLATING & COLOR
UNLESS OTHERWISE SPECIFIED TOLERANCES		东莞市汉博电子科技有限公司 DONGGUAN HANBO TECHNOLOGY CO., LTD		
DECIMALS:	ANGLES:	TITLE	SD CARD CONN SHORT BODY SMT	
X :±0.35	X :±2°	DWN	xiong	SD-112S
X.X :±0.25	X.X :±1°	CHKD	lee	SCALE:1:1 UNIT: mm
X.XX :±0.15		APVD	wang	SIZE: A4 SHEET:10F 1 REV: A4
CUSTOMER COPY				

X-ON Electronics

Largest Supplier of Electrical and Electronic Components

Click to view similar products for [Memory Card Connectors](#) category:

Click to view products by [Hanbo Electronic](#) manufacturer:

Other Similar products are found below :

[M21-033321-005](#) [6407-249V-25273P](#) [6407-249V-25343P](#) [6426-201-21343](#) [69.920.0553.0](#) [MCR60A-98D-2.54DSA\(70\)](#) [809180410000000](#)
[DM3AT-SF-PEJM5\(41\)](#) [IC11S-BUR-PNEJL\(71\)](#) [252-0144-000](#) [2041353-2](#) [308-DS1P0811-192](#) [HM2P09PDR360N9LF](#) [10014744-011TLF](#)
[11327-001](#) [11327-002](#) [617230001](#) [NX1-32T-KT3K\(05\)](#) [N7E50-U516RB-50-SIN0005](#) [68-580163-21S](#) [125A-78C00](#) [CCM03-3109 B LFT](#)
[2309923-1](#) [61126-050CAHLF](#) [IC1GA-68PD-1.27DS-EJ\(72\)](#) [GTFP08432B1HR](#) [SCE2MSDZN76A121SN](#) [10014744-011ALF](#) [10014744-](#)
[011LF](#) [10057542-1211FLF](#) [10067972-000LF](#) [10067972-050LF](#) [10122302-20110LF](#) [G85D1162022HHR](#) [MUP-C7809-1](#) [NANO SIM 7P](#)
[H1.37](#) [MICRO SIM 7P H1.35](#) [TF-CARD H1.8 SY](#) [MICRO SIM 6P H1.35](#) [TF-CARD H1.8](#) [TF-115Y-BCP9](#) [TF-115YY-ACP9](#) [SMN-309-](#)
[ARP6](#) [TF-115Y-ACP9](#) [TF-108-ARP10](#) [SMN-303S-ACP7](#) [SNO-14100](#) [SD-112S](#) [MUP-C7804-1](#) [47309-2651](#)