



REV.	ECN NO OR DESCRIPTION	REVISED	DATE

A

B

C

D

A

B

C

D

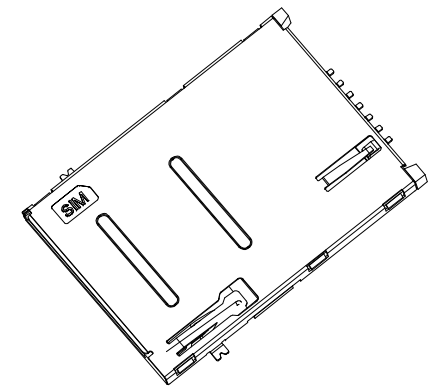
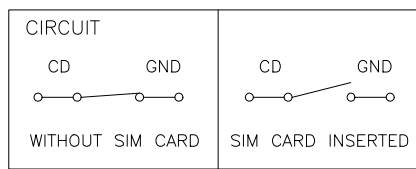
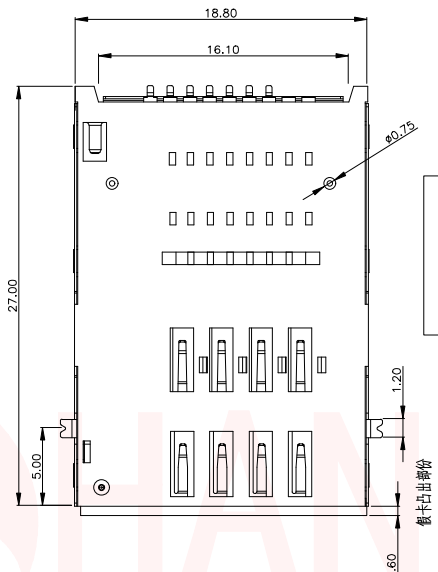
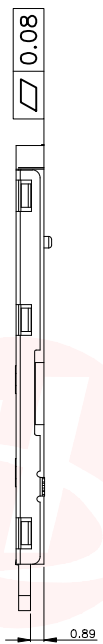
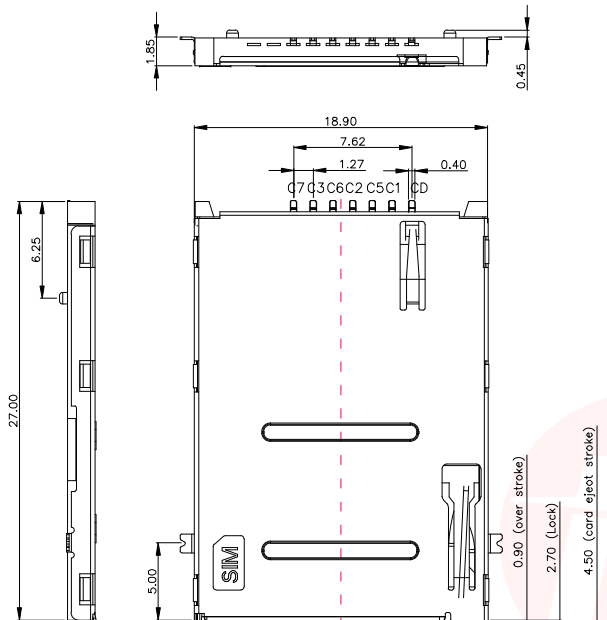

- Notes:
- Material:
 - Housing:LCP Color:black(塑胶材质: LCP 94-V0 黑色)
 - Contact:Phosphor Bronze.(端子材质: 磷青铜)
 - SHELL:SUS (外壳材质: 不锈钢)
 - All Ni30u"Min Contact 1u",solder area Tin 30u/min(全部镀层30u", 接触点1u", 焊接处每30u")
 - shell Ni 30" min ,solder gold Flash (镀层30"u,焊接处镀金)

pin no.	name
C1	vcc of sim
C2	rst of sim
C3	clk of sim
C5	gnd of sim
C6	vpp of sim
C7	I/O of sim
C4/C8	n/a

- SPECIFICATION:
- DURABILITY: 5000 CYCLES MIN(寿命:5000次最小)
 - CURRENT:0.5A (额定电流: 0.5Amps)
 - VOLTAGE:40V MAX(额定电压: 40V最大)
 - WITHSTANDING VOLTAGE:500V AC MIN.(UNMATED) (额定电压: 500V AC最小)
 - CONTACT RESISTANCE:30mΩ MAX.(端子接触电阻: 30mΩ最大)
 - INSULATION RESISTANCE:1000MΩ MIN.(UNMATED) (绝缘电阻: 1000兆欧最小)
 - OPERATING TEMPERATURE RANGE:-40.C TO +85.C(工作环境温度: -40度到+80度)
 - ALL THE MATERIAL SHOULD COMPLY WITH THE ROHS (全部材质符合ROHS)

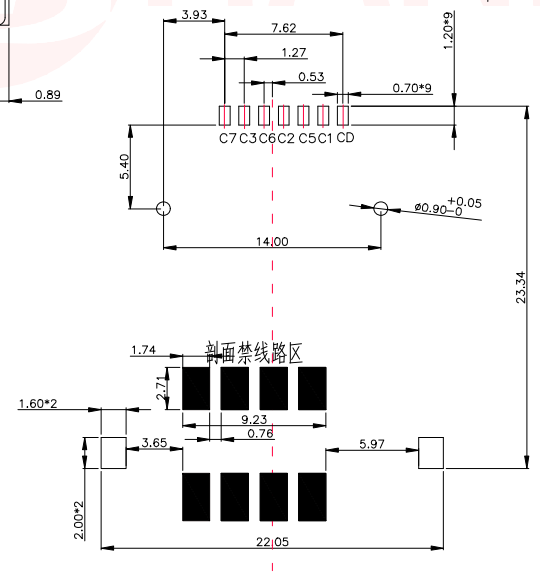
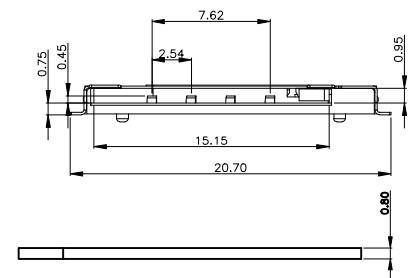

RECOMMENDED PCB LAYOUT
GENERAL TOLERANCE ±0.05

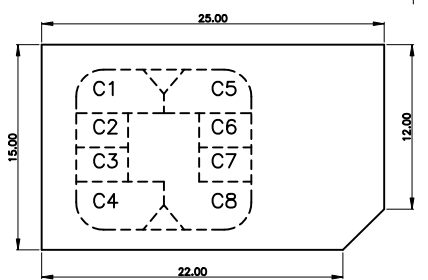

UNLESS OTHERWISE SPECIFIED TOLERANCES		东莞市汉博电子科技有限公司 DONGGUAN HANBO TECHNOLOGY CO., LTD			
DECIMALS:	ANGLES:	TITLE	MINI SIM PUSH 6P+1P 有柱右开关后脚		
X :±0.5	X :±2°	DWN	xiong	SIM-210	
X.X :±0.20	X.X :±1°	CHKD	lee	SCALE:1:1	UNIT: mm
X.XX :±0.10		APVD	wang	SIZE: A4	SHEET:10F 1
		REV: A4			
CUSTOMER COPY					

1

2

3

4

5

6

X-ON Electronics

Largest Supplier of Electrical and Electronic Components

Click to view similar products for [Memory Card Connectors](#) category:

Click to view products by [Hanbo Electronic](#) manufacturer:

Other Similar products are found below :

[6407-249V-25273P](#) [6407-249V-25343P](#) [6426-201-21343](#) [69.920.0553.0](#) [MCR60A-98D-2.54DSA\(70\)](#) [809180410000000](#) [DM3AT-SF-PEJM5\(41\)](#) [IC11S-BUR-PNEJL\(71\)](#) [C70210M0083692](#) [2041353-2](#) [308-DS1P0811-192](#) [HM2P09PDR360N9LF](#) [10014744-011TLF](#) [11327-001](#) [11327-002](#) [NX1-32T-KT3K\(05\)](#) [95622-003LF](#) [84648-056HLF](#) [CCM03-3109 B LFT](#) [MS3116J10-6PW](#) [2309923-1](#) [61126-050CAHLF](#) [GTFP08432B1HR](#) [G85D1160022HHR](#) [SCE2MSDZN76A121SN](#) [10014744-011ALF](#) [10014744-011LF](#) [10057542-1211FLF](#) [10067972-000LF](#) [10067972-050LF](#) [10122302-20110LF](#) [G85D1162022HHR](#) [TF-05A](#) [M6014-12](#) [XKNANO-1412](#) [SMN-304-ARP6](#) [MIS11-S1F1-2000-A](#) [SMN-308-ARSP7](#) [MCS-302S-KT1B](#) [SMN-308-ACSP7](#) [K-DYX-008](#) [K-DYX-004](#) [HYCW126-TF18-150B](#) [C7024-03](#) [SMO-1030](#) [MCS-110-KT](#) [SIM-217](#) [SNO-1355-KT](#) [SMO-1025-P10](#) [SIM-211S-P6](#)