

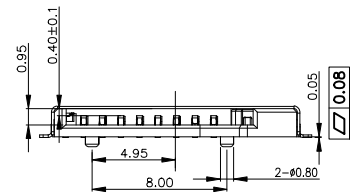

REV.	ECN NO OR DESCRIPTION	REVISED	DATE

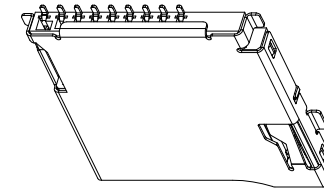

PIN NO.	NAME	YTYPE	DESCRIPTION
1	DAT2	I/O/PP	DATE LINE(BIT2)
2	CD/DAT3	I/O/PP	CARD DETECT DATE LIN(BIT3)
3	CMD	PP	COMMAND RESPONSE
4	VDD	S	SUPPLY VOLTAGE
5	CLX	I	CLOCK
6	VSS	S	SUPPLY VOLTAGE GROUND
7	DAT0	I/O/PP	DATE LINE(BIT0)
8	DAT1	I/O/PP	DATE LINE(DIT1)
9	CD	CD	CD

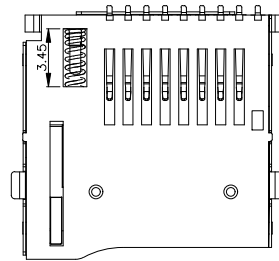
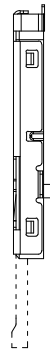
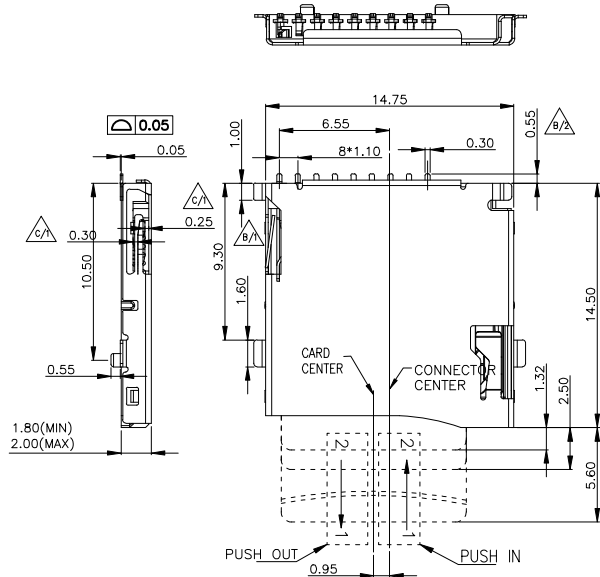
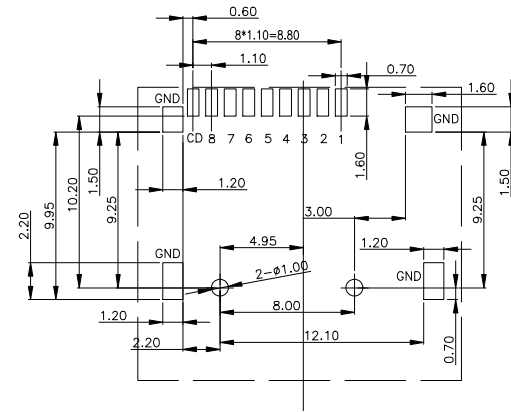

RECOMMENDED P.C.B HOLE LAYOUT
COMPONENT SIDE VIEW(TOLERANCE: +/-0.05)

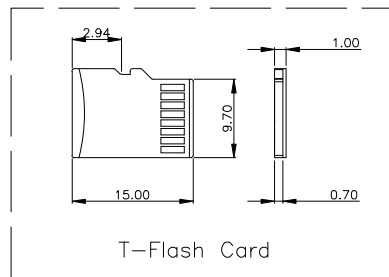

- NOTES:
 1.MATERIAL:
 HOUSING: HIGH TEMPERATURE THERMOPLASTIC
 UL94V_0,COLOR:BLACK.
 CONTACT: COPPER ALLOYS.
 COVER: COPPER ALLOYS OR STEEL.
 2.PLATING:
 UNDERPLATE: NICKEL.
 CONTACT AREA: GOLD OVER NICKEL.
 SOLDER AREA: TIN OVER NICKEL.
 3.MULTIMEDIA CARD COMPATIBLE

UNLESS OTHERWISE SPECIFIED TOLERANCES		东莞市汉博电子科技有限公司 DONGGUAN HANBO TECHNOLOGY CO., LTD			
DECIMALS:	ANGLES:	TITLE	T-FLASH 外焊 PUSH 脚位镀金		
X :±0.5	X :±2°	DWN	xiong	TF-012D	
X.X :±0.20	X.X :±1°	CHKD	lee	SCALE:1:1	UNIT: mm
X.XX :±0.10		APVD	wang	SIZE: A4	SHEET:10F 1
CUSTOMER COPY					

X-ON Electronics

Largest Supplier of Electrical and Electronic Components

Click to view similar products for [Memory Card Connectors](#) category:

Click to view products by [Hanbo Electronic](#) manufacturer:

Other Similar products are found below :

[M21-033321-005](#) [6407-249V-25273P](#) [6407-249V-25343P](#) [69.920.0553.0](#) [809180410000000](#) [DM3AT-SF-PEJM5\(41\)](#) [HMCAP001](#) [252-0144-000](#) [2041353-2](#) [308-DS1P0811-192](#) [33CFAE-DN](#) [HM2P09PDR360N9LF](#) [502431-1011](#) [10-629549-258N](#) [11327-001](#) [11327-002](#) [617230001](#) [95622-003LF](#) [N7E50-U516RB-50-SIN0005](#) [95079-00CALF](#) [84648-056HLF](#) [93-570123-08P](#) [125A-78C00](#) [MI20A-50PD-SF-EJL\(71\)](#) [KP10S-SF-PEJ\(812\)](#) [504536-0691](#) [CCM03-3109 B LFT](#) [MI21-50PD-SF\(91\)](#) [2309923-1](#) [61126-050CAHLF](#) [IC1GA-68PD-1.27DS-EJ\(72\)](#) [GTFFP08432B1HR](#) [G85DT17001P1EU](#) [G85C11101152HHR](#) [G85D1160022HHR](#) [KP15TL-SF\(800\)](#) [KP10BH-8S-SF\(800\)](#) [SCE2MSDB76A121SN](#) [SCE2MSDZN76A121SN](#) [C00710B0250001](#) [CCM01-2664 LFT T25](#) [47309-2651](#) [47481-0001](#) [055036006202862+](#) [67799-0004](#) [91228-3006](#) [104168-1616](#) [104C-TAA1](#) [112I-TA01](#) [112K-TAA0-RA1](#)